



**BDK  
GLASS**

## Společnost BDK-GLASS, spol. s r.o.



BDK-GLASS, spol. s r.o. je specifickou firmou v rámci sklářského průmyslu díky své výrobní technologii FUSING.

Společnost BDK-GLASS byla založena v r. 1991. Již v roce 1992 byla technologie fusing výrobně odzkoušena a obchodně zhodnocena. S postupným rozšiřováním výrobní kapacity docházelo i k diverzifikaci podnikatelské činnosti – k nákupu zařízení pro pískování skla, CNC řezání skla, postavena kontinuální plynová pec atd. Společnost vyrábí zejména dekorativní a užitkové mísy, misky, tácy a talíře, skleněné svícný, dárkové předměty.

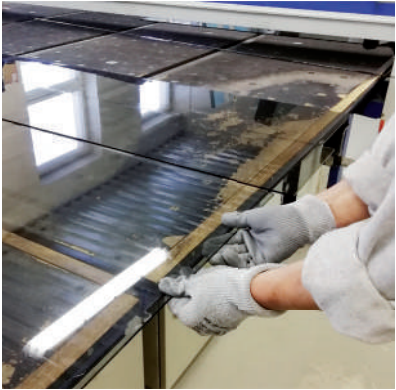

Na zakázku vyrábí i skleněné výplně do dveří a skleněné stoly. Společnost si vytvořila vlastní osobitý styl. Sama si zpracovává návrhy výrobků, které se vyznačují moderním designem a originalitou. Výroba je zcela ekologická, v podstatě bezodpadová.

Od svého počátku společnost dodává své výrobky zejména na zahraniční trhy ve vyspělých evropských zemích a severní Americe. BDK-GLASS, spol. s r.o. disponuje zbožím, které odběratele zajímá svojí variabilitou a originalností ruční práce. Významnými zákazníky jsou v posledních letech i cateringové společnosti.

Filosofie výroby BDK-GLASS, spol. s r.o. spočívá v hromadné flexibilní výrobě širokého sortimentu výrobků s maximálním důrazem na design výrobku a v přijatelné cenové hladině.



## Company BDK-GLASS, spol. s r.o.

BDK-GLASS was established in Czechoslovakia in 1991. We are a small, family company whose production is focused on the manual processing of clear and coloured flat glasses through the FUSING technology.

FUSING is based on fusing flat glasses together and subsequently shaping them in furnaces at temperatures around 800°C. Our company mainly supplies large and small bowls, trays, coasters, decorative candlesticks, gift items, and original glass trophies.

These products are used mainly in food preparation and service, flower arranging, and residential architecture and decoration. We also produce glass door panels, kitchen cabinet panels, glass tables, and more.

We enjoy creating our own modern designs with fresh styles and originality, and this creativity has become a characteristic feature of our company. However, we are very flexible and we are happy to satisfy customer proposals. Although we produce our glass by hand, we keep our prices favourable for every customer. Production is ecological and basically wasteless.

BDK-GLASS mainly exports its product to European countries and North America. Customers especially appreciate our products' versatility and the originality that comes from manual processes.

## OBSAH

Talíře   Plates	5 - 17
Tácy   Trays	19 - 29
Mísy   Bowls	31 - 39
Rautové schody a etažéry   Step trays	41 - 50
Dekoratívni svícny   Candlesticks	52 - 61
Dekoratívni mísy   Decorative bowls	63 - 64
Barevný vzorník   Range of colors in production	66

# TALÍŘE | PLATES

*Plates*

*Talíře*



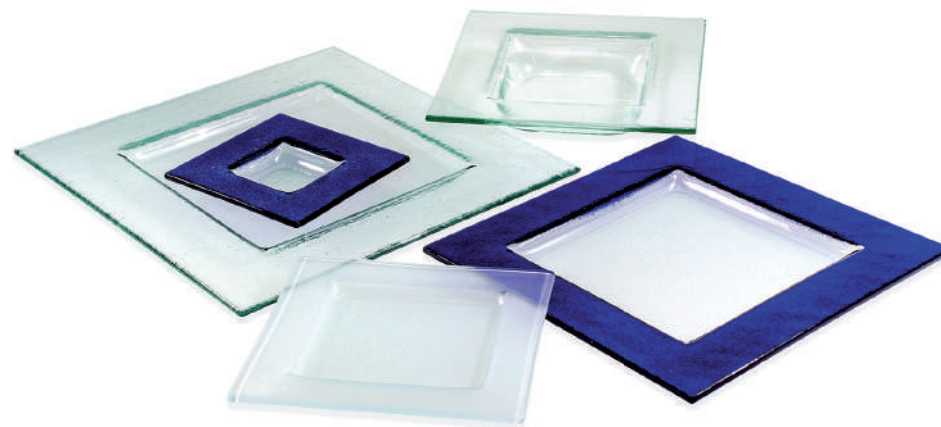
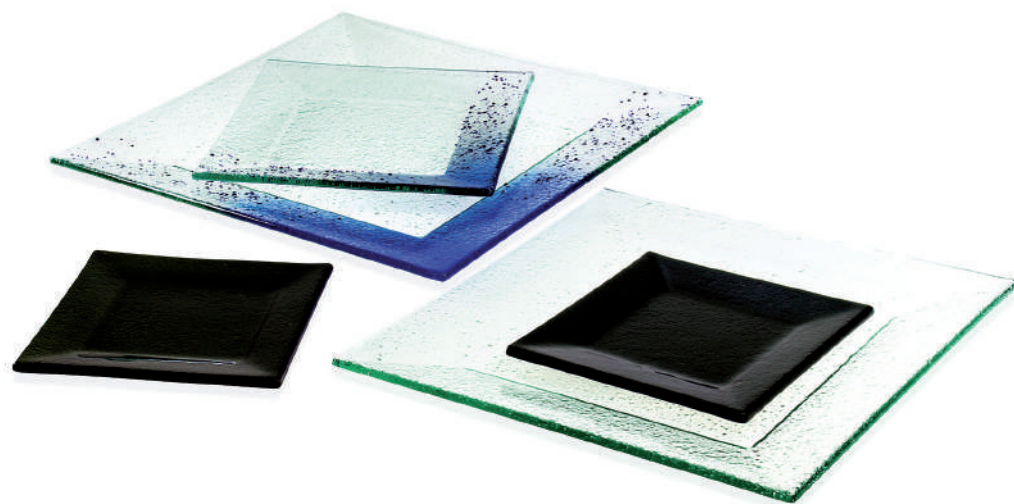

## TALÍŘE MAX | MAX PLATES

**Kód | Code**   **Rozměr | Size**

5300xx	15 x 15 cm
5301xx	20 x 20 cm
5302xx	28 x 28 cm
5303xx	32 x 32 cm

xx - Dvojcísli určující barvu výrobku  
xx - Number of individual color

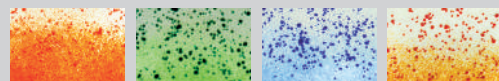

01 red   02 green   03 blue   04 orange

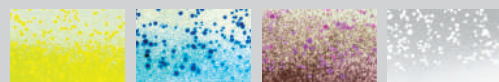

06 yellow   08 turquoise   09 violet   10 white



20 clear   21 sanded   22 dark grey   30 grey



## TALÍŘE BORDER | BORDER PLATES

**Kód | Code**   **Rozměr | Size**

5091xx	13 x 13 cm
5093xx	17 x 17 cm
5095xx	21 x 21 cm   hloubka depth 3 cm
5097xx	25 x 25 cm
5099xx	31 x 31 cm

xx - Dvojcísli určující barvu výrobku  
xx - Number of individual color



01 red   02 green   03 blue   04 orange



06 yellow   07 beige   08 light turquoise   19 violet

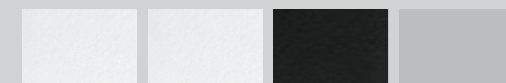

20 clear   21 sanded   22 dark grey





Nature talíře kulaté |  
Nature plates str. 11

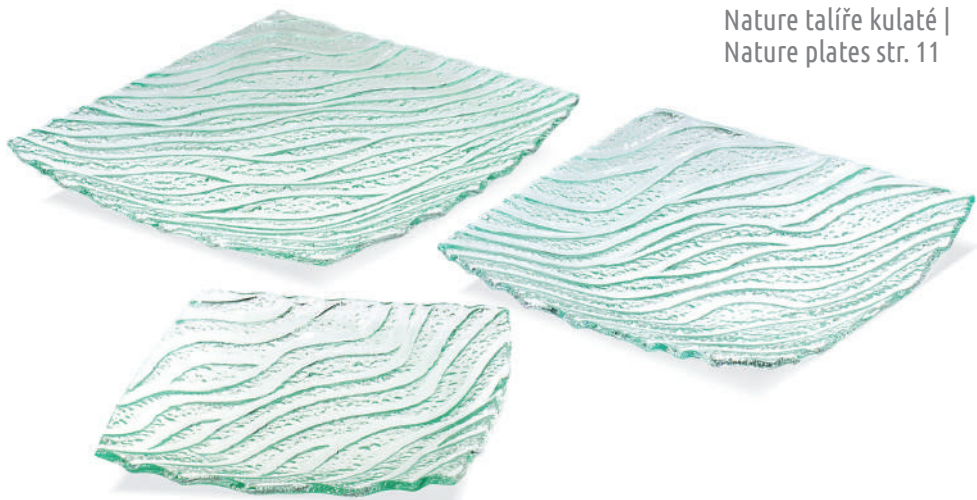

Nature talíře kulaté |  
Nature plates str. 11

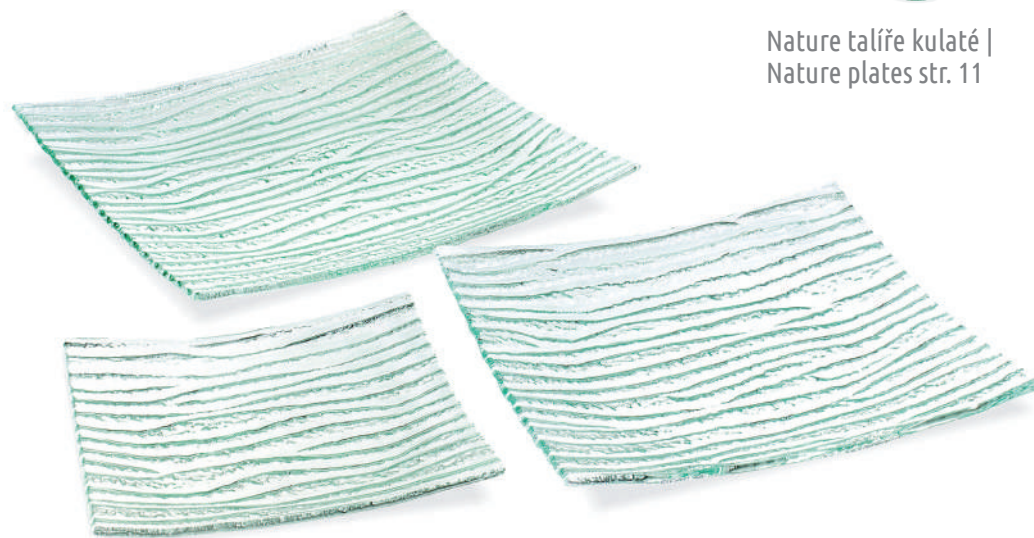

## TALÍŘE NATURE | NATURE PLATES

**Kód | Code**   **Rozměr | Size**

535x1y     20 x 20 cm

535x3y     27 x 27 cm

535x5y     31 x 31 cm

x - Číslice určující barvu výrobku  
x - Number of individual color

y - Číslice určující strukturu výrobku  
y - Number of individual structure

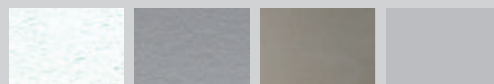

2 clear     5 grey     8 bronze     x



1 moonoscape     2 bark     3 sea     y



## TALÍŘE NATURE | NATURE PLATES

**Kód | Code**   **Rozměr | Size**

535x1y     20 x 20 cm

535x3y     27 x 27 cm

535x5y     31 x 31 cm

x - Číslice určující barvu výrobku  
x - Number of individual color

y - Číslice určující strukturu výrobku  
y - Number of individual structure

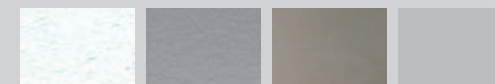

1 clear     4 grey     7 bronze     x



1 moonoscape     2 bark     3 sea     y



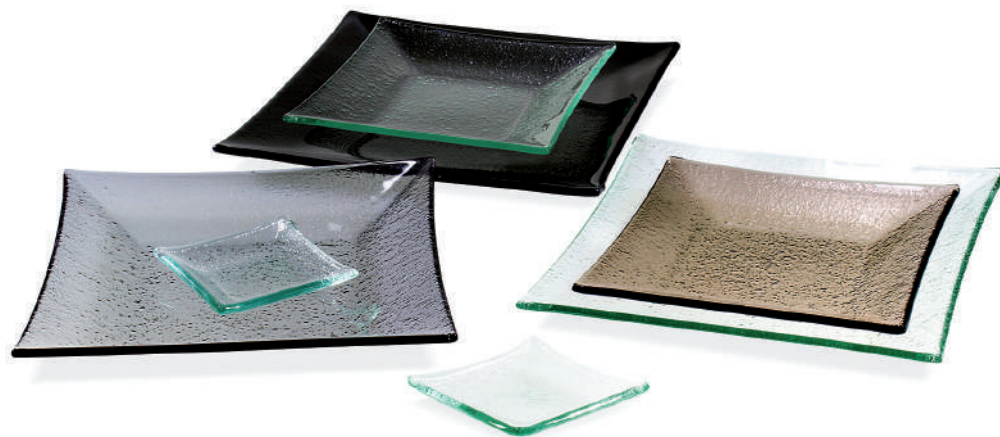



Cubo mísy | bowls str. 34

## TALÍŘE SAFARI | SAFARI PLATES

## TALÍŘE CUBO | CUBO PLATES

Kód   Code	Rozměr   Size
 5280xx	13 x 13 cm
5281xx	16 x 16 cm
5282xx	20 x 20 cm
5283xx	25 x 25 cm
5285xx	31 x 31 cm
 5284xx	29 x 29 cm   hloubka depth 5 cm

xx - Dvojcísle určující barvu výrobku  
xx - Number of individual color

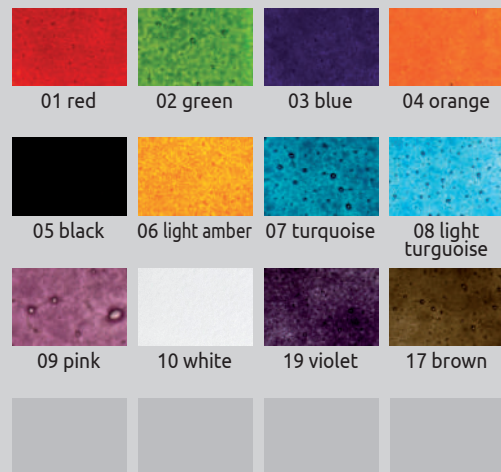

Kód   Code	Rozměr   Size
5252x0	10 x 10 cm
5252x2	20 x 20 cm
5252x4	25 x 25 cm
5252x6	28 x 28 cm

x - Číslice určující barvu výrobku  
x - Number of individual color

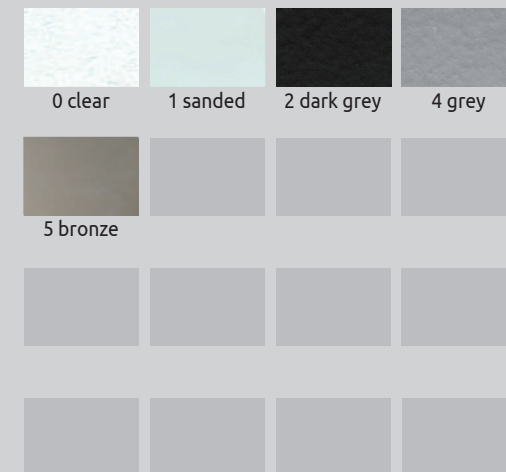



## TALÍŘE BAND | BAND PLATES

**Kód | Code**   **Rozměr | Size**

5061xx	ø 13 cm
5062xx	ø 20 cm
5064xx	ø 26 cm
5066xx	ø 32 cm
5068xx	ø 40 cm

xx - Dvojcíslný určující barvu výrobku  
xx - Number of individual color



## TALÍŘE FLASH | FLASH PLATES

**Kód | Code**   **Rozměr | Size**

54460xx	ø 11 cm
54465xx	ø 32 cm

xx - Dvojcíslný určující barvu výrobku  
xx - Number of individual color

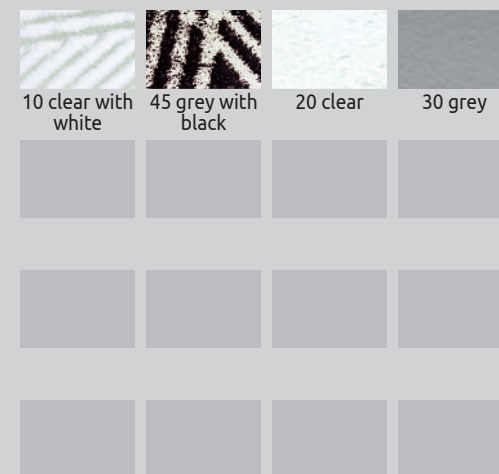



## TALÍŘE CAKE | CAKE PLATES

## TALÍŘE BUBBLE | BUBBLE PLATES

**Kód | Code**   **Rozměr | Size**

50730xx    ø 16 cm

50733xx    ø 28 cm

50736xx    ø 33 cm

xx - Dvojcíslní určující barvu výrobku  
xx - Number of individual color



**MĚLKÉ TALÍŘE | SHALLOW PLATES**

**Kód | Code**   **Rozměr | Size**

52042xx    ø 20 cm

52012xx    ø 28 cm

52032xx    ø 31 cm

**HLUBOKÉ TALÍŘE | DEEP PLATES**

**Kód | Code**   **Rozměr | Size**

52052xx    ø 17 cm

52022xx    ø 26 cm

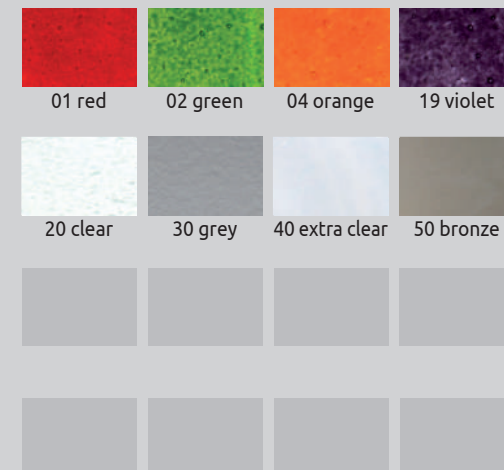

52062xx    ø 31 cm

xx - Dvojcíslní určující barvu výrobku  
xx - Number of individual color

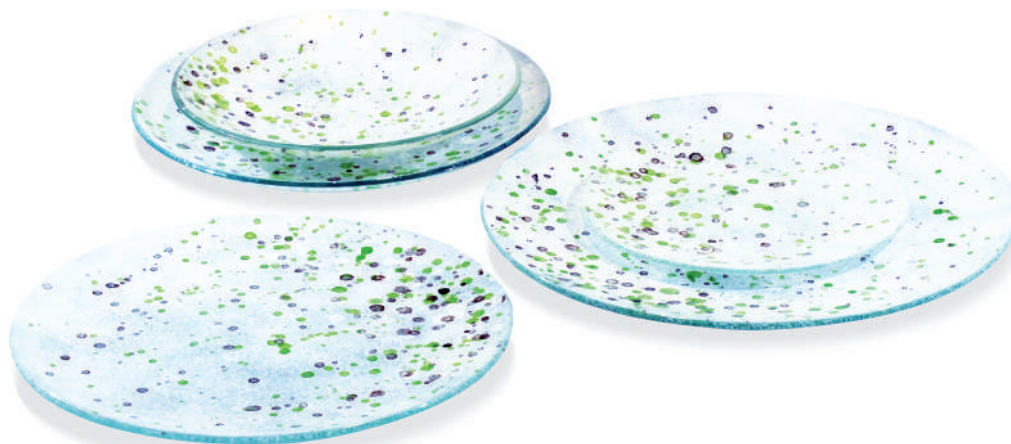





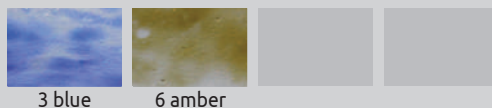

## TALÍŘE COUNTRY I. | COUNTRY I. PLATES

Kód   Code	Rozměr   Size
 5473022x ø 20 cm	
5473222x ø 28 cm	
 5473422x ø 25 cm	
5473522x ø 29 cm	

x - Číslice určující barvu výrobku  
x - Number of individual color



## TALÍŘE COUNTRY II. | COUNTRY II. PLATES

Kód   Code	Rozměr   Size
 5471020xx ø 20 cm	
5471220xx ø 28 cm	
5471420xx ø 33 cm	
 5471120xx ø 25 cm	
 5471320xx ø 28 cm	
 5471520xx ø 29 cm	

xx - Dvojcíslicí určující barvu výrobku  
xx - Number of individual color



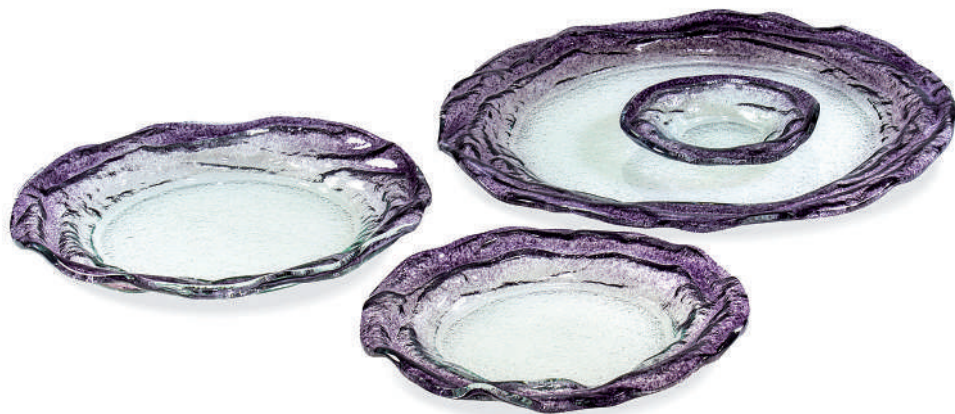

Nature talíře čtvercové |  
Nature plates str. 6



Nature talíře čtvercové |  
Nature plates str. 6

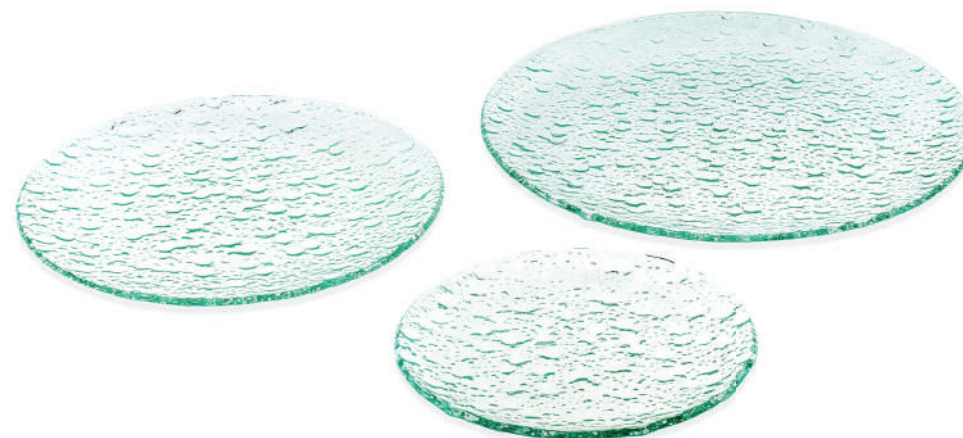

## TALÍŘE MELODY | MELODY PLATES

## TALÍŘE NATURE | NATURE PLATES

### Kód | Code Rozměr | Size

54471xx	ø 13 cm
54473xx	ø 21 cm
54475xx	ø 25 cm
54477xx	ø 33 cm

xx - Dvojcísle určující barvu výrobku  
xx - Number of individual color



### Kód | Code Rozměr | Size

535x1y	ø 21 cm
535x3y	ø 28 cm
535x5y	ø 35 cm

x - Číslice určující barvu výrobku  
x - Number of individual color

y - Číslice určující strukturu výrobku  
y - Number of individual structure

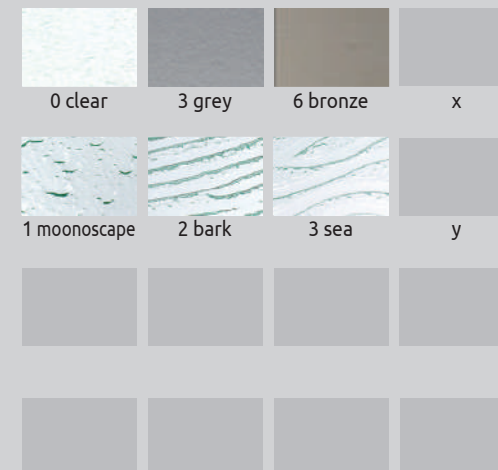



Etažér | Cake 3-storey  
whatnot - str. 50



Etažér |  
Cake whatnot - str. 49



## TALÍŘE VELO | VELO PLATES

Kód | Code      Rozměr | Size

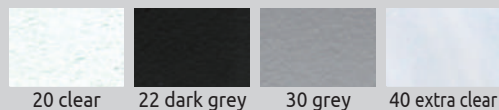

	55134xx	ø 20 cm
	55138xx	ø 28 cm
	55132xx	ø 18 cm
	55136xx	ø 23 cm

xx - Dvojcíslní určující barvu výrobku  
xx - Number of individual color



## TALÍŘE STUMP | STUMP PLATES

Kód | Code      Rozměr | Size

	55102xx	ø 20 cm
	55106xx	ø 28 cm
	55104xx	ø 24 cm



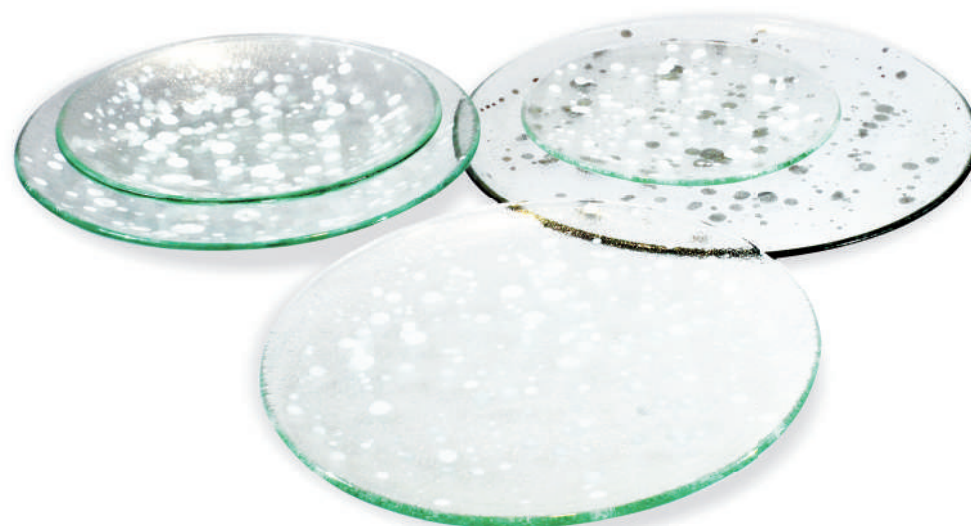

xx - Dvojcíslní určující barvu výrobku  
xx - Number of individual color





## TALÍŘE COUNTRY III. | COUNTRY III. PLATES

## TALÍŘE COUNTRY IV. | COUNTRY IV. PLATES





Kód   Code	Rozeř   Size
 547202xy ø 20 cm	
 547222xy ø 28 cm	
 547242xy ø 25 cm	
 547252xy ø 29 cm	

x - Číslice určující barvu okraje  
x - Number of rim color

y - Číslice určující barvu výrobku  
y - Number of individual color



další barevné varianty - viz. vzorník barev - str. 66  
another color variations can be found in the color swatch - p. 66

Kód   Code	Rozeř   Size
 547203xx ø 20 cm	
 547223xx ø 28 cm	
 547243xx ø 25 cm	
 547253xx ø 29 cm	

xx - Dvočíslí určující barvu výrobku  
xx - Number of individual color

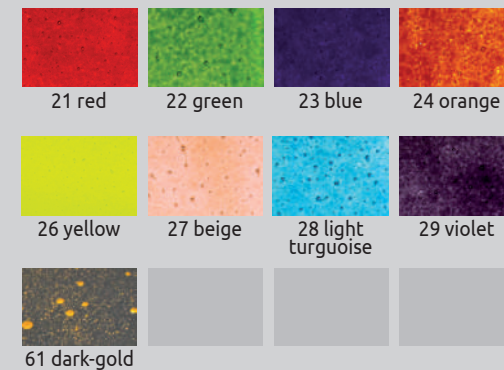

další barevné varianty - viz. vzorník barev - str. 66  
another color variations can be found in the color swatch - p. 66





Talíře ANTIQUE I  
ANTIQUÉ Plates str. 15

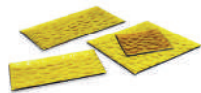

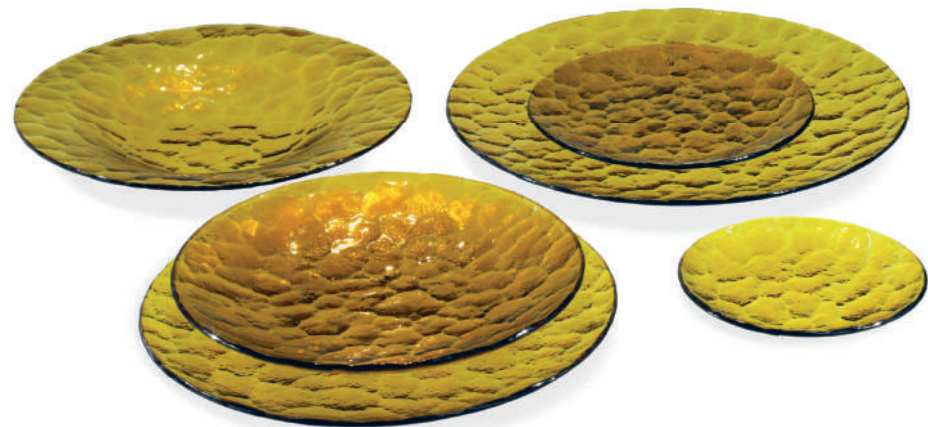

Tácy ANTIQUE I  
ANTIQUÉ Trays str. 25



Oval Ella II. talíře | Oval  
Ella II. plates - str. 17



## TALÍŘE ANTIQUE | ANTIQUÉ PLATES

Kód   Code	Rozměr   Size
 5056101	ø 15 cm
5056111	ø 20 cm
5056131	ø 28 cm
5056161	ø 33 cm
 5056141	ø 28 cm
 5056181	ø 25 cm
5056191	ø 29 cm



amber



## KULATÉ TALÍŘE ELLA | ROUND ELLA PLATES

Kód   Code	Rozměr   Size
547202xx	ø 20 cm
547222xx	ø 28 cm
547232xx	ø 28 cm   hluboký deep

xx - Dvojčíslí určující barvu ráfku  
xx - Number of rim color



80 gold

90 silver





## TALÍŘE OLYMPIA | OLYMPIA PLATES

**Kód | Code**   **Rozměr | Size**

51552xx   26 x 11 cm

51554xx   33 x 14 cm

xx - Dvojčíslí určující barvu výrobku  
xx - Number of individual color



40 extra clear



Talíře ANTIQUE I  
ANTIQUÉ Plates str. 14

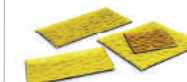

Tácky ANTIQUE I  
ANTIQUÉ Trays str. 25



## TALÍŘE ANTIQUE | ANTIQUE PLATES

**Kód | Code**   **Rozměr | Size**

5056311   20 x 14 cm

5056331   30 x 23 cm

5056351   34 x 26 cm



amber



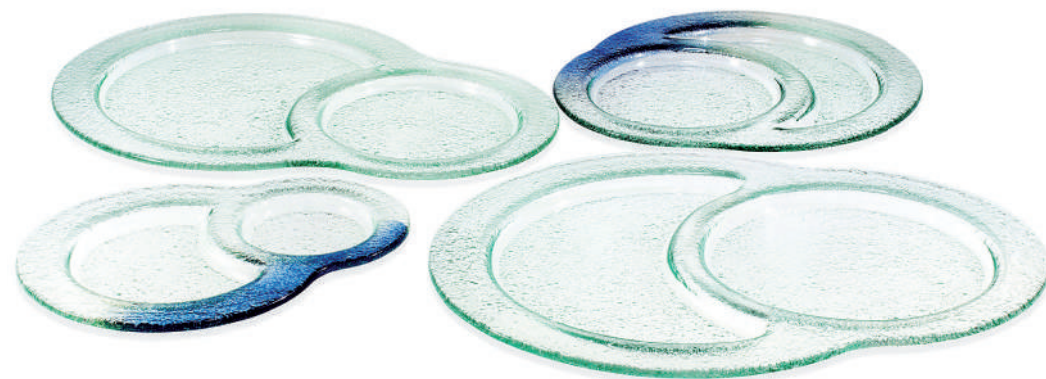

## TALÍŘE AMEBA I. | AMEBA I. PLATES

**Kód | Code**   **Rozměr | Size**

5360xx	19 x 15 cm
5362xx	24 x 19 cm
5364xx	29 x 24 cm
5366xx	40 x 24 cm

xx - Dvojcíslní určující barvu výrobku  
xx - Number of individual color



## TALÍŘE AMEBA II. | AMEBA II. PLATES

**Kód | Code**   **Rozměr | Size**

5376xx	25 x 18 cm
5370xx	26 x 28 cm
5372xx	37 x 30 cm
5374xx	38 x 28 cm

xx - Dvojcíslní určující barvu výrobku  
xx - Number of individual color





Kulaté talíře Ella | Round  
Ella plates - str. 14



## TALÍŘE OVAL ELLA | OVAL ELLA PLATES

## TALÍŘE OVAL ELLA II. | OVAL ELLA II. PLATES

Kód | Code    Rozměr | Size

51571xx    20 x 14 cm

51573xx    30 x 23 cm

51575xx    34 x 26 cm

xx - Dvojcíslní určující barvu výrobku  
xx - Number of individual color

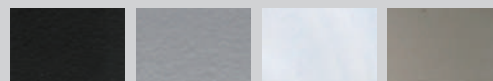

22 dark grey    30 grey    40 extra clear    50 bronze



Kód | Code    Rozměr | Size

51571xx    20 x 14 cm

51573xx    30 x 23 cm

51575xx    34 x 26 cm

xx - Dvojcíslní určující ráfek výrobku  
xx - Number of rim color



80 gold    90 silver





TÁCY | TRAYS  
*Trays* *Tácy*



Obdelníkové tácy ZOOM I. I ZOOM I. Trays str. 24



Tácy ZOOM II. I ZOOM II. Trays str. 29



Kulaté tácy ZOOM I Round ZOOM Trays str. 28



Servírovací tácy I SERVING Trays str. 26

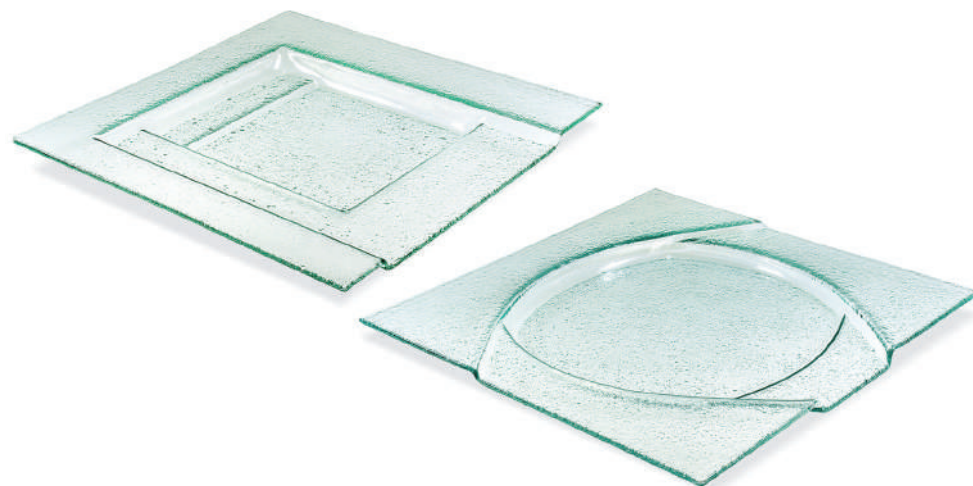
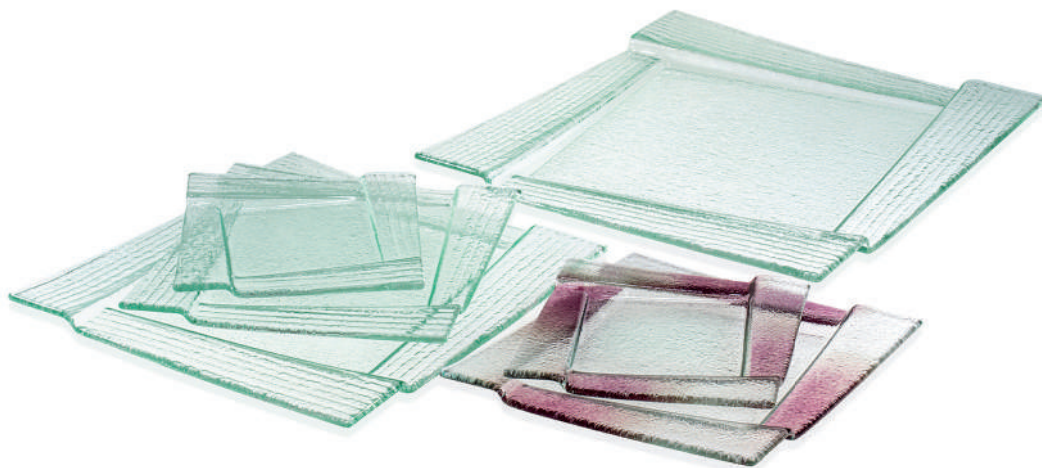

## ČTVERCOVÉ TÁCY ZOOM | ZOOM SQUARE TRAYS

## SERVÍROVACÍ TÁCY | SERVING TRAYS

Kód | Code    Rozměr | Size

54511xx	15 x 15 cm
54513xx	20 x 20 cm
54515xx	26 x 26 cm
54517xx	32 x 32 cm

xx - Dvojcísli určující barvu výrobku  
xx - Number of individual color

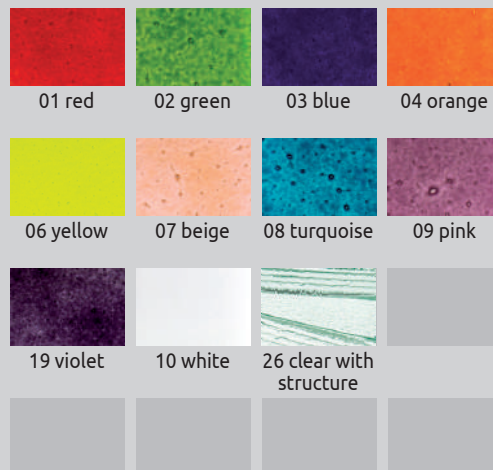

Kód | Code    Rozměr | Size

5400xx	40 x 40 cm
--------	------------

xx - Dvojcísli určující barvu výrobku  
xx - Number of individual color





## TÁČY STONES | STONES TRAYS

**Kód | Code**   **Rozměr | Size**

54301xx	26 x 15 cm
54303xx	30 x 22 cm
54304xx	30 x 30 cm
54305xx	45 x 30 cm

xx - Dvojcíslní určující barvu výrobku  
xx - Number of individual color



40 extra clear



## TÁČY BOND | BOND TRAYS

**Kód | Code**   **Rozměr | Size**

54351xx	13 x 13 cm
54353xx	20 x 20 cm
54355xx	33 x 16 cm
54357xx	45 x 20 cm

xx - Dvojcíslní určující barvu výrobku  
xx - Number of individual color

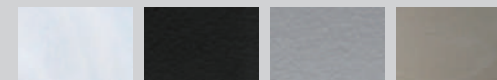

40 extra clear   22 dark grey   30 grey   50 bronze



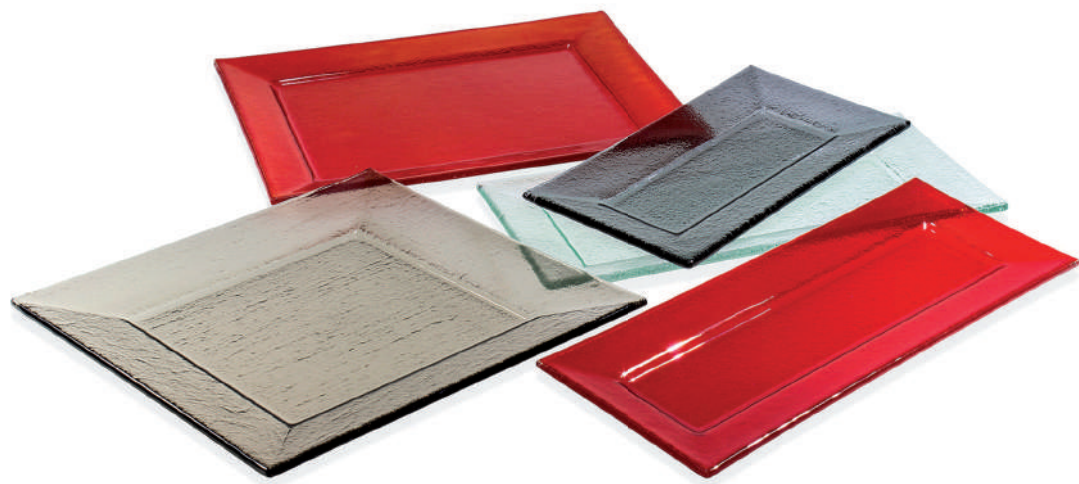

## TÁČY MAXIM | MAXIM TRAYS

## TÁČY LED | LED TRAYS

**Kód | Code**    **Rozměr | Size**

53131xx	23 x 13 cm
53135xx	25 x 25 cm
53132xx	29 x 15 cm
53134xx	29 x 23 cm
53133xx	32 x 12 cm

xx - Dvojcíslní určující barvu výrobku  
xx - Number of individual color



**Kód | Code**    **Rozměr | Size**

	56036x5	22 x 22 cm
	56036x4	24 x 10 cm
	56036x2	26 x 10 cm
	56036x6	28 x 13 cm
	56036x1	34 x 10 cm
	56036x3	22 x 22 cm

x - Číslice určující barvu výrobku  
x - Number of individual color







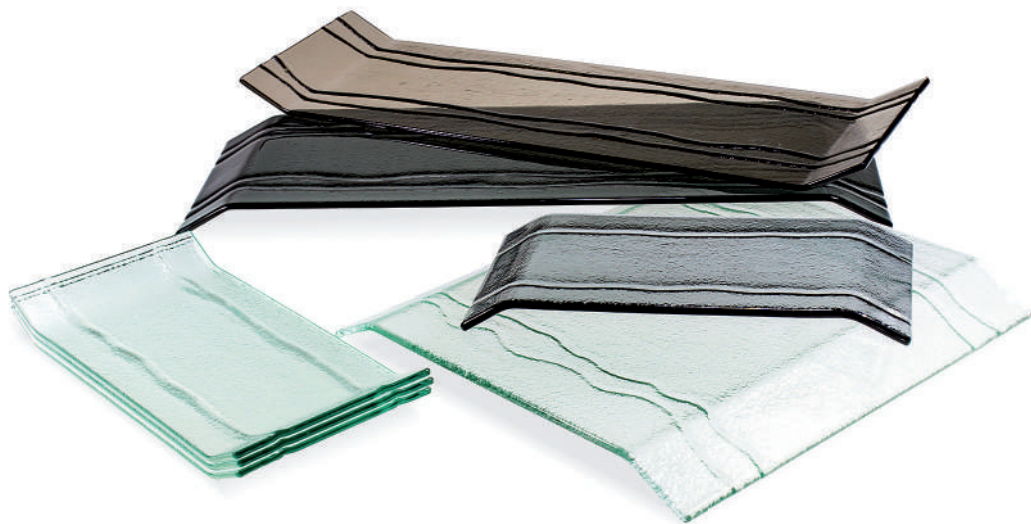

Mísy POCKET |  
POCKET Bowls - str. 32



## TÁCKY POCKET | POCKET TRAYS

Kód   Code	Rozměr   Size
 512x48	10 x 10 cm
512x04	13 x 13 cm
512x49	12 x 12 cm
512x34	14 x 14 cm
 512x05	23 x 13
 512x06	34 x 13 cm
 512x29	45 x 13 cm

x - Číslice určující barvu výrobku  
x - Number of individual color

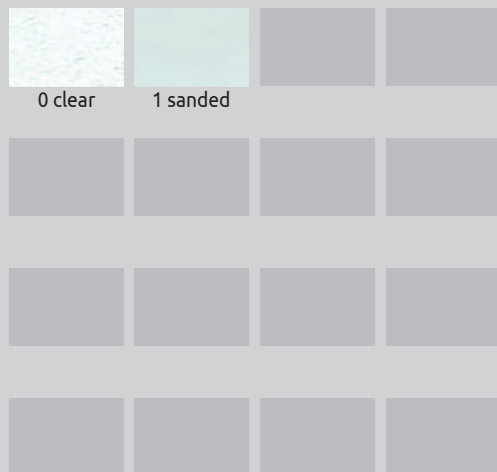

## TÁČY BRIDGE | BRIDGE TRAYS

Kód   Code	Rozměr   Size
54111xx	24 x 12 cm
54113xx	28 x 28 cm
54112xx	45 x 15 cm

xx - Dvojcíslicí určující barvu výrobku  
xx - Number of individual color

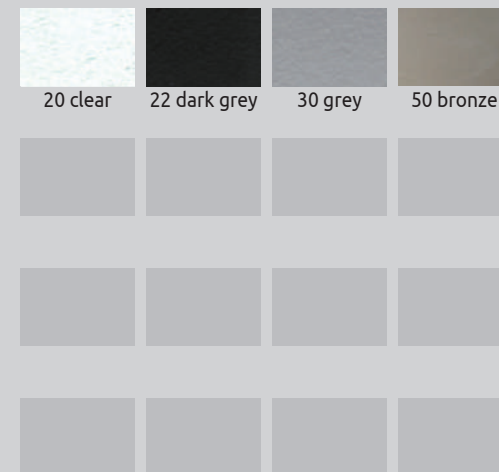



## GN TÁCY | GN TRAYS (GASTRONORM)

**Kód | Code**   **Rozměr | Size**

54611xx	10,8 x 17,6 cm
54612xx	17,6 x 16,2 cm
54613xx	26,5 x 16,3 cm
54614xx	32,5 x 17,6 cm
54615xx	32,5 x 26,5 cm
54616xx	35,4 x 32,5 cm
54617xx	53 x 32,5 cm

xx - Dvojcísli určující barvu výrobku  
xx - Number of individual color

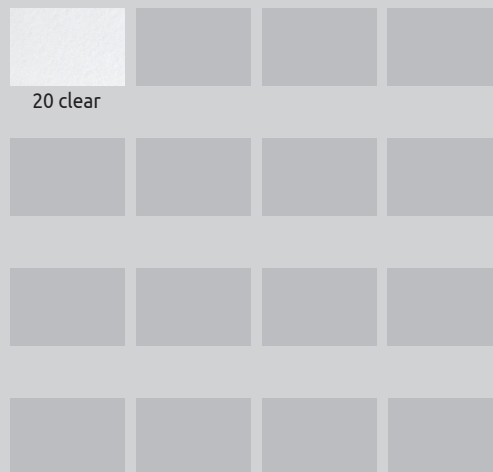

## GN BAREVNÉ TÁCY | GN COLOR TRAYS

**Kód | Code**   **Rozměr | Size**

5402xx	53 x 32,5 cm
--------	--------------

xx - Dvojcísli určující barvu výrobku  
xx - Number of individual color

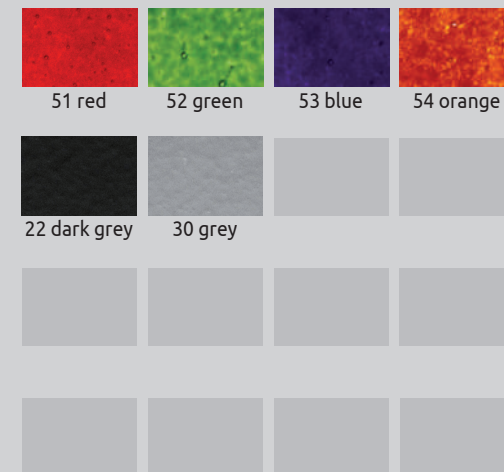

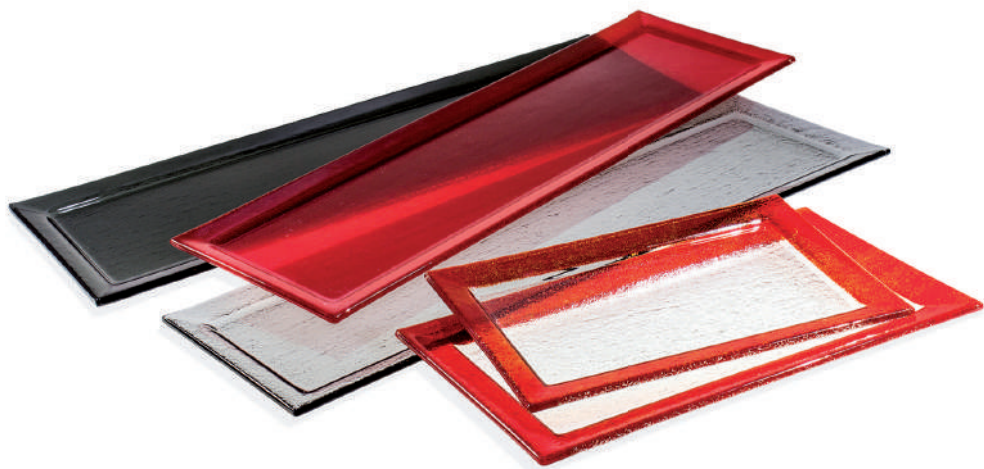

Čtvercové tácy ZOOM  
I Square ZOOM Trays  
str. 19



Tácy ZOOM Eye I ZOOM  
Eye Trays str. 29



Kulaté Tácy ZOOM I  
Round ZOOM Trays str. 28



## PODNOŠY MAX GN | MAX GN TRAYS

### JEDNOBAREVNÉ | FULLCOLORED

**Kód | Code**   **Rozměr | Size**

53113xx   26,5 x 16,3 cm

53114xx   32,5 x 17,6 cm

53118xx   53 x 16,2 cm

### BAREVNÝ OKRAJ | COLORED RIM

**Kód | Code**   **Rozměr | Size**

53123xx   26,5 x 16,3 cm

53124xx   32,5 x 17,6 cm

53128xx   53 x 16,2 cm

xx - Dvojcíslní určující barvu výrobku  
xx - Number of individual color

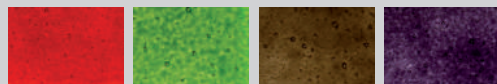

01 red   02 green   17 brown   19 violet



09 pink   10 white



JEDNOBAREVNÉ | ONLY FULL COLOR VERSION

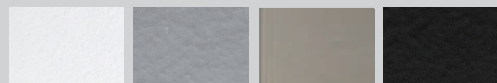

20 clear   30 grey   50 bronze   22 dark grey

## OBDELNÍKOVÉ TÁCY ZOOM | ZOOM TRAYS

**Kód | Code**   **Rozměr | Size**

54523xx   30 x 15 cm

54525xx   40 x 17 cm

54526xx   45 x 20 cm

xx - Dvojcíslní určující barvu výrobku  
xx - Number of individual color



01 red   02 green   03 blue   04 orange



06 yellow   07 beige   08 turquoise   09 pink



19 violet   10 white   26 clear with structure



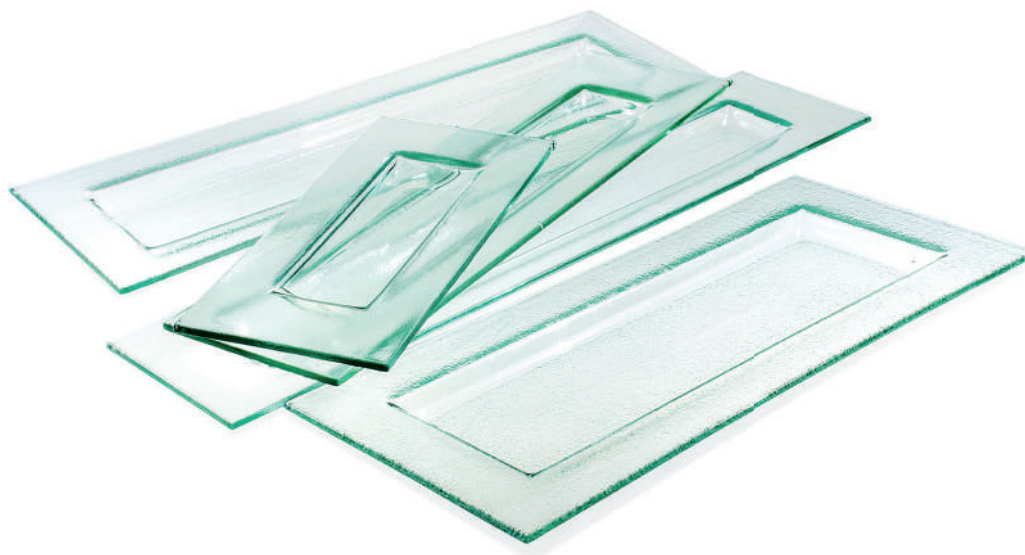

Talíře ANTIQUE I  
ANTIQUÉ Plates str. 14



Talíře ANTIQUE I  
ANTIQUÉ Plates str. 15

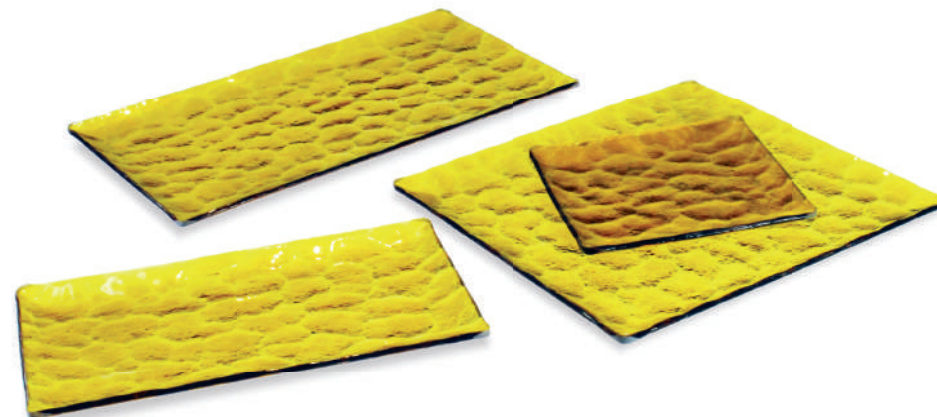

## TÁČY LONG | LONG TRAYS

## TÁČY ANTIQUE | ANTIQUÉ TRAYS

**Kód | Code**      **Rozměr | Size**

51901xx	31 x 13 cm
51905xx	45 x 20 cm
51902xx	49 x 13 cm
51904xx	53 x 16 cm
51903xx	59 x 13 cm

xx - Dvojčíslí určující barvu výrobku  
xx - Number of individual color

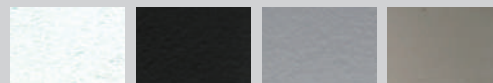

20 clear    22 dark grey    30 grey    50 bronze



**Kód | Code**      **Rozměr | Size**

5056211	14,5 x 14,5 cm
5056231	24,5 x 14,5 cm
5056241	31 x 17,5 cm
5056261	24,5 x 24,5 cm



amber





Servírovací tácy I  
SERVING Trays str. 21

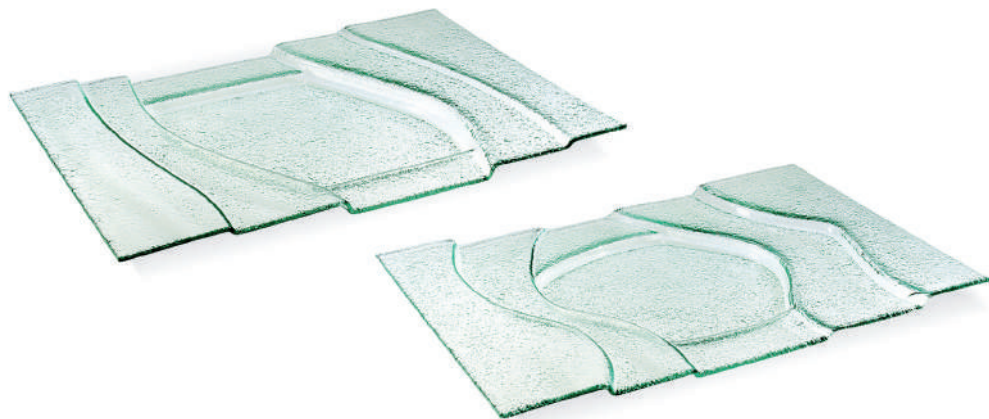

## SERVÍROVACÍ TÁCY | SERVING TRAYS

**Kód | Code**   **Rozměr | Size**

5400xx   50 x 35 cm

xx - Dvojcíslní určující strukturu výrobku  
xx - Number of structure



03

04



## TÁCY CASTLE | CASTLE TRAYS

**Kód | Code**   **Rozměr | Size**

54343xx   38 x 18 cm

54345xx   48 x 24 cm

xx - Dvojcíslní určující barvu výrobku  
xx - Number of individual color



20 clear

40 extra clear



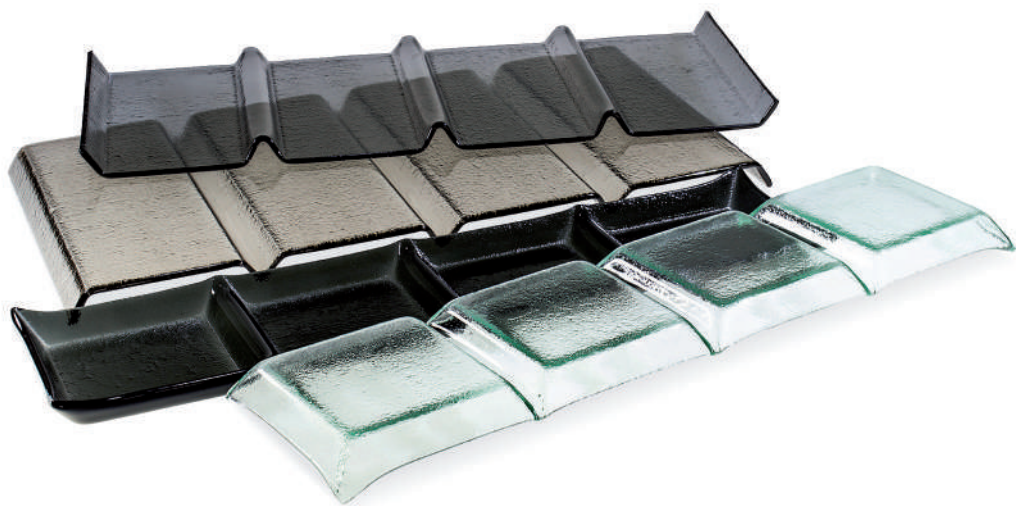

## TÁČY CHOCOLATE | CHOCOLATE TRAYS

## TÁČY CHOCOLATE | CHOCOLATE TRAYS

**Kód | Code**   **Rozměr | Size**

54220xx   52 x 13 cm

54221xx   52 x 20 cm

54222xx   52 x 25 cm

xx - Dvojčíslí určující barvu výrobku  
xx - Number of individual color

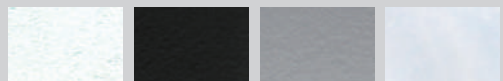

20 clear   22 dark grey   30 grey   40 extra clear



50 bronze



**Kód | Code**   **Rozměr | Size**

54223xx   41 x 41 cm

xx - Dvojčíslí určující barvu výrobku  
xx - Number of individual color

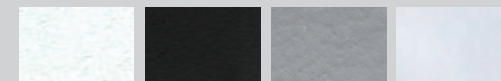

20 clear   22 dark grey   30 grey   40 extra clear



50 bronze





Čtvercové tácy ZOOM  
I ZOOM Square Trays  
str. 19



Obdelníkové tácy ZOOM  
I ZOOM II. Trays str. 24



Tácy ZOOM EYE I ZOOM  
EYE Trays str. 29



## TÁCY TREBLE | TREBLE TRAYS

Kód | Code    Rozměr | Size

54333xx    ø 31 cm

54331xx    35 x 20 cm

xx - Dvojičíslo určující barvu výrobku  
xx - Number of individual color



20 clear    30 grey



## KULATÉ TÁCY ZOOM | ROUND ZOOM TRAYS

Kód | Code    Rozměr | Size

54501xx    ø 16 cm

54503xx    ø 22 cm

54504xx    ø 25 cm | hloubka  
depth 4 cm

54505xx    ø 30 cm

54507xx    ø 36 cm

xx - Dvojičíslo určující barvu výrobku  
xx - Number of individual color



01 red    02 green    03 blue    04 orange



06 yellow    07 beige    08 turquoise    09 pink



19 violet    10 white    26 clear with  
structure





Čtvercové tácy ZOOM I  
Square ZOOM Trays  
str. 19



Obdelníkové tácy ZOOM I  
ZOOM II. Trays str. 24



Kulaté tácy ZOOM I  
Round ZOOM Trays str. 28

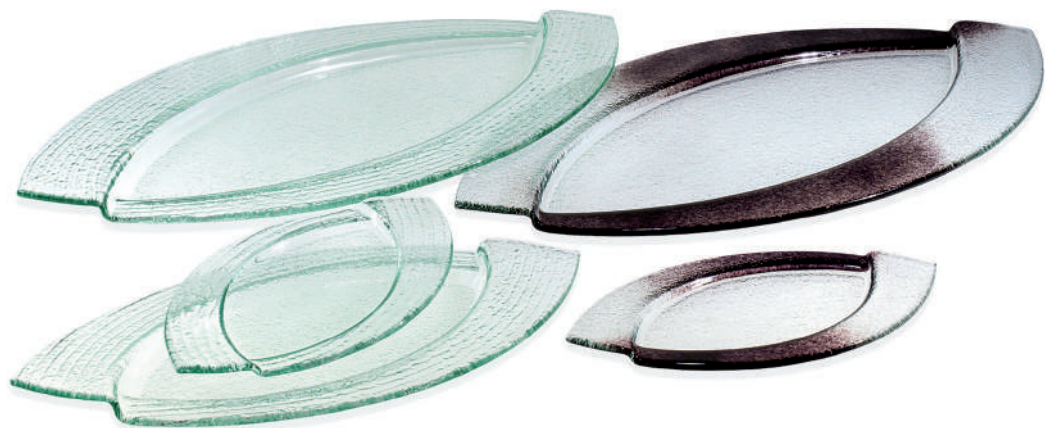

## TÁCY ZOOM EYE | ZOOM EYE TRAYS

## TÁCY OVAL | OVAL TRAYS

**Kód | Code**   **Rozměr | Size**

54532xx   25 x 14 cm

54535xx   35 x 20 cm

54538xx   50 x 29 cm

xx - Dvojčíslí určující barvu výrobku  
xx - Number of individual color



01 red   02 green   03 blue   04 orange



06 yellow   07 beige   08 turquoise   09 pink



19 violet   10 white   26 clear with structure



**Kód | Code**   **Rozměr | Size**

54122xx   36 x 13 cm

54123xx   48 x 18 cm

54125xx   60 x 22 cm

xx - Dvojčíslí určující barvu výrobku  
xx - Number of individual color



30 grey   20 clear   26 clear with structure





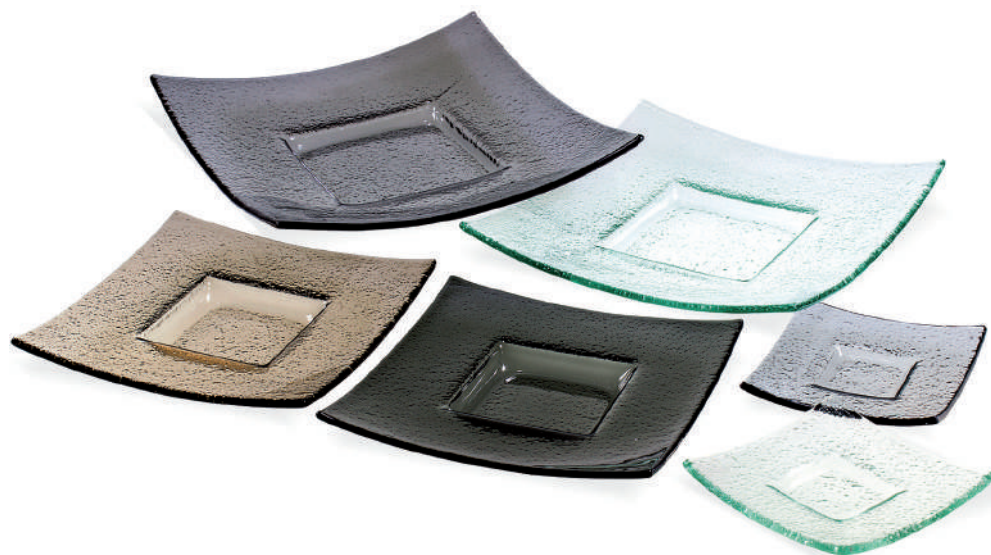

MÍSY | BOWLS  
*Bowls* *Misy*



## MÍSY ORNAMENTAL | ORNAMENTAL BOWLS

## MÍSY PROLIS | PROLIS BOWLS

Kód   Code	Rozměr   Size
 505x28	30 x 30 cm hluboká   deep
 505x18	30 x 30 cm mělká   shallow

x - Číslice určující strukturu výrobku  
x - Number of structure



1 krizet 3 grosfield 4 stalactit



Kód   Code	Rozměr   Size
54231xx	12 x 12 cm
54233xx	20 x 20 cm
54235xx	25 x 25 cm
54237xx	30 x 30 cm
54239xx	38 x 38 cm

xx - Dvojčíslí určující barvu výrobku  
xx - Number of individual color

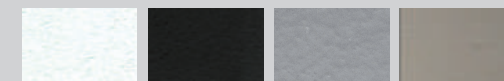

20 clear 22 dark grey 30 grey 50 bronze



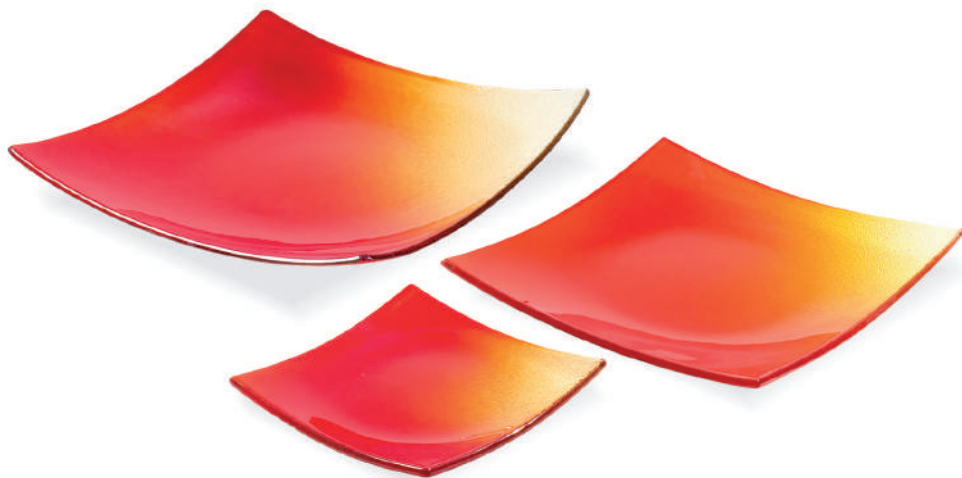

Tácy POCKET |  
POCKET Trays - str. 22



## MÍSY MATIZ | MATIZ BOWLS

Kód   Code	Rozměr   Size
5040xx	15 x 15 cm
5042xx	23 x 23 cm
5041xx	30 x 30 cm

xx - Dvojcíslný určující barvu výrobku  
xx - Number of individual color





01 red 02 green 03 blue 04 orange



06 yellow 20 clear 21 sanded 22 dark grey



## MÍSY POCKET | POCKET BOWLS

Kód   Code	Rozměr   Size
 55053xx	23 x 23 x 1 cm
55051xx	26 x 26 x 1,5 cm
55054xx	26 x 26 x 3 cm
55052xx	30 x 30 cm x 1,5 cm
55056xx	23 x 23 x 3 cm
 55055xx	26 x 26 x 1,5 cm

xx - Dvojcíslný určující barvu výrobku  
xx - Number of individual color

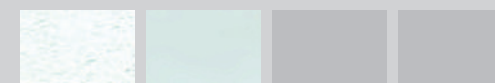

20 clear 21 sanded



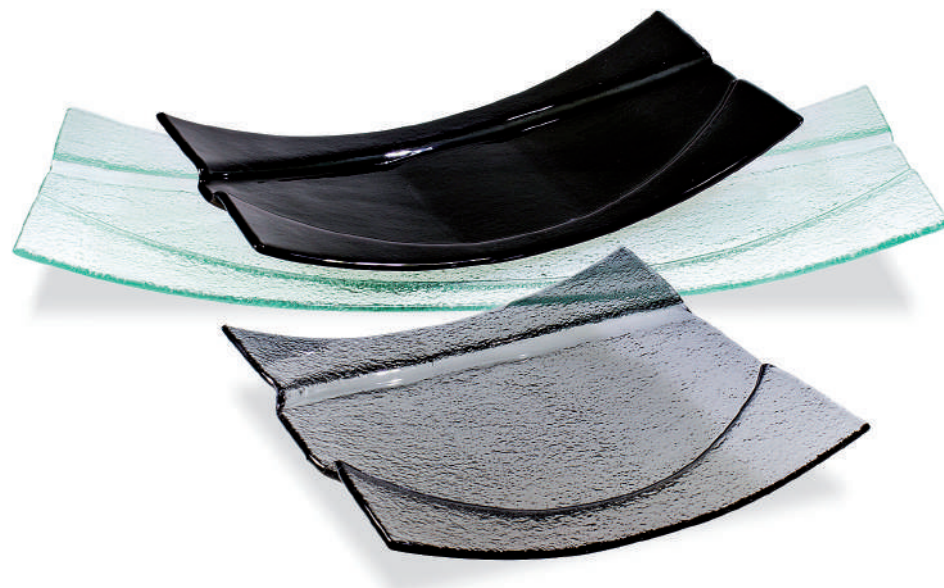

## MÍSY SALAD III. | SALAD III. BOWLS

## MÍSY SWING | SWING BOWLS

Kód   Code	Rozměr   Size
55441xx	14 x 14 cm hluboká 4 cm   depth 4 cm
55442xx	19 x 19 cm hluboká 5 cm   depth 5 cm

xx - Dvojčíslí určující barvu výrobku  
xx - Number of individual color

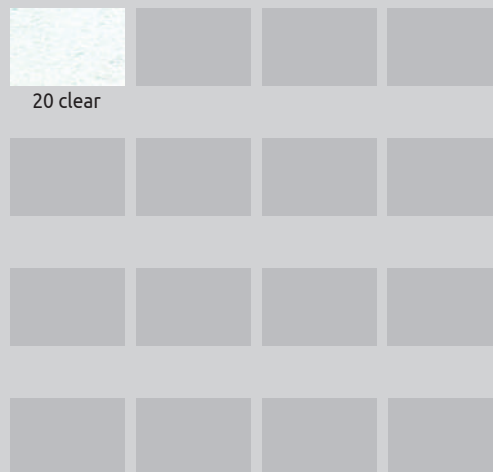

Kód   Code	Rozměr   Size
54101xx	28 x 28 cm
54102xx	43 x 20 cm
54103xx	60 x 24 cm

xx - Dvojčíslí určující barvu výrobku  
xx - Number of individual color

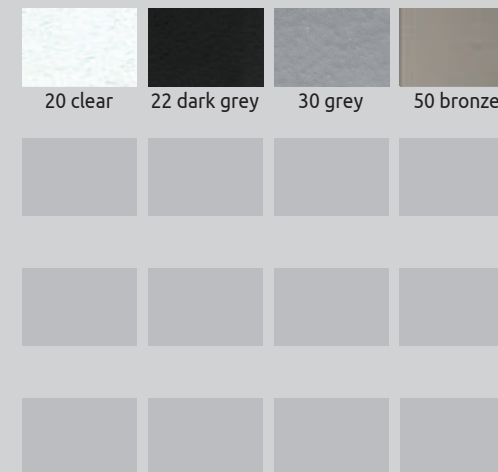

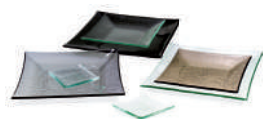

Cubo talíře |  
Cubo plates str. 7

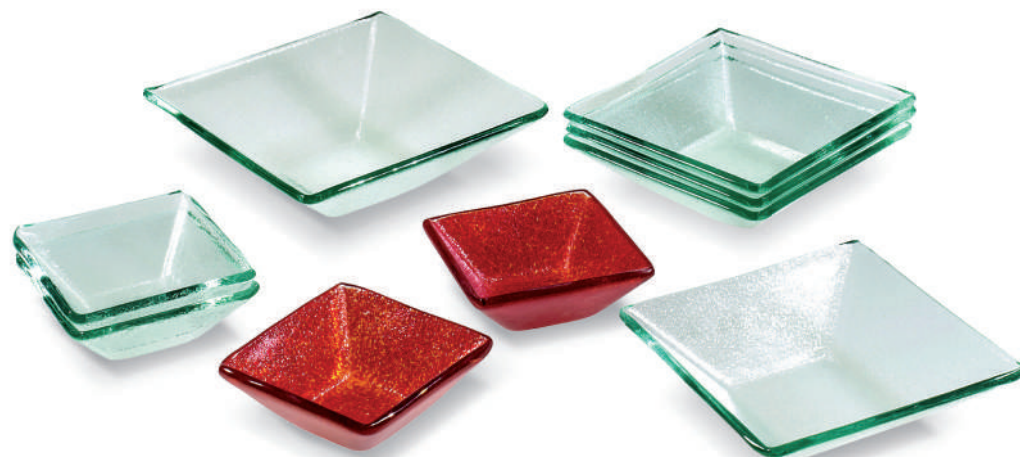
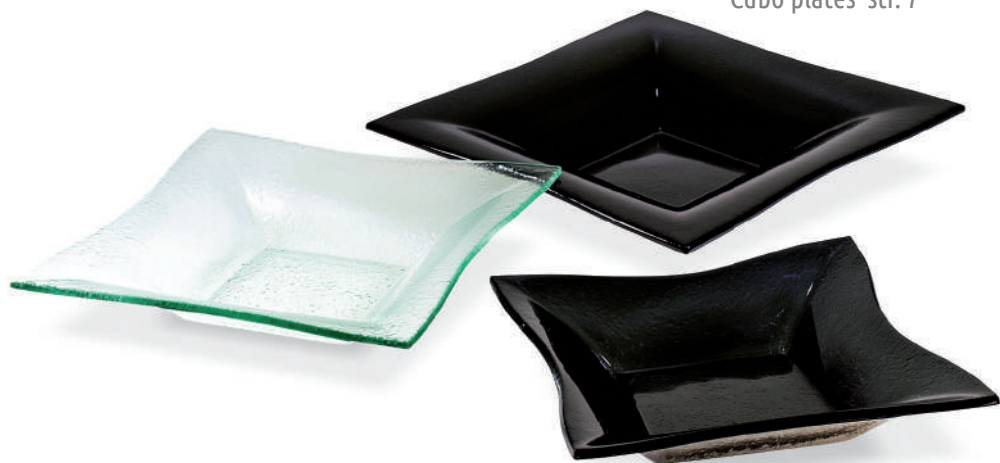

## MÍSY CUBO | CUBO BOWLS

Kód | Code    Rozměr | Size

5252x7    23 x 23 cm

5252x8    26 x 26 cm

5252x9    29 x 29 cm

x - Číslice určující barvu výrobku  
x - Number of individual color

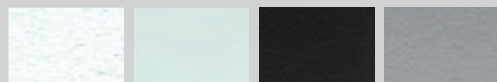

## MÍSY SALAD I. | SALAD I. BOWLS

Kód | Code    Rozměr | Size

53352xx    9 x 9 cm    hluboká 3,5 cm  
| depth 3,5 cm

55431xx    13 x 13 cm    hluboká 3,5 cm  
| depth 3,5 cm

55432xx    15 x 15 cm    hluboká 4,5 cm  
| depth 4,5 cm

xx - Dvojcísli určující barvu výrobku  
xx - Number of individual color

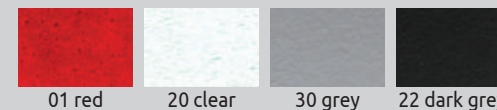

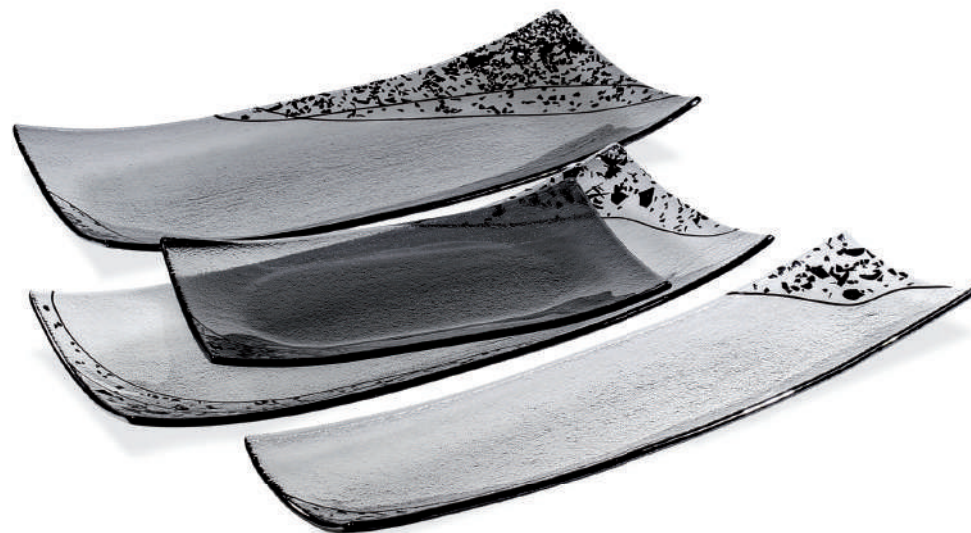

## MÍSY TUBE LINKY | TUBE LINKY BOWLS

Kód | Code      Rozměr | Size

54312xx      30 x 18 cm

54315xx      42 x 18 cm

54313xx      45 x 13 cm

xx - Dvojcíslní určující barvu výrobku  
xx - Number of individual color



29 extra clear  
with black and  
silver lines

49 grey with  
black and  
silver lines

69 dark grey  
with white  
lines



## MÍSY TUBE | TUBE BOWLS

Kód | Code      Rozměr | Size

54312xx      30 x 17 cm

54313xx      45 x 13 cm

54315xx      45 x 20 cm

54317xx      48 x 23 cm

xx - Dvojcíslní určující barvu výrobku  
xx - Number of individual color

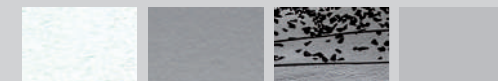

20 clear

30 grey

45 grey  
with black





## MÍSY KAMENY | KAMENY BOWLS

**Kód | Code**   **Rozměr | Size**

56034x2	13 x 13 cm
56034x3	19 x 11 cm
56034x7	23 x 17 cm
56034x8	23 x 23 cm
56034x9	36 x 17 cm

x - Číslice určující barvu výrobku  
x - Number of individual color

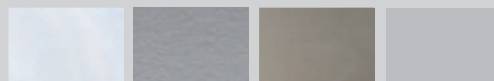

0 extra clear   2 grey   3 bronze



## MÍSY VALENCE | VALENCE BOWLS

**Kód | Code**   **Rozměr | Size**

51520xx	42 x 22 cm
---------	------------

xx - Dvojcíslicí určující barvu výrobku  
xx - Number of individual color

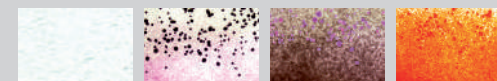

20 clear   09 pink   19 violet   01 red

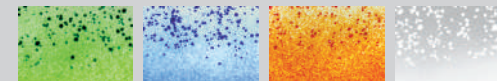

02 green   03 blue   04 orange   10 white





## MÍSY PASTA | PASTA BOWLS

Kód | Code    Rozměr | Size

54246xx    ø 29 cm

xx - Dvojcíslní určující barvu výrobku  
xx - Number of individual color



## MÍSY KISS | KISS BOWLS

Kód | Code    Rozměr | Size

54451xx    ø 9,5 cm

54453xx    ø 16 cm

54455xx    ø 20 cm

54457xx    ø 32 cm

xx - Dvojcíslní určující barvu výrobku  
xx - Number of individual color





## MÍSY LEAF | LEAF BOWLS

**Kód | Code**   **Rozměr | Size**

5150xxx   47 x 19 cm

xxx - Trojčíslí určující barvu výrobku  
xxx - Number of individual color

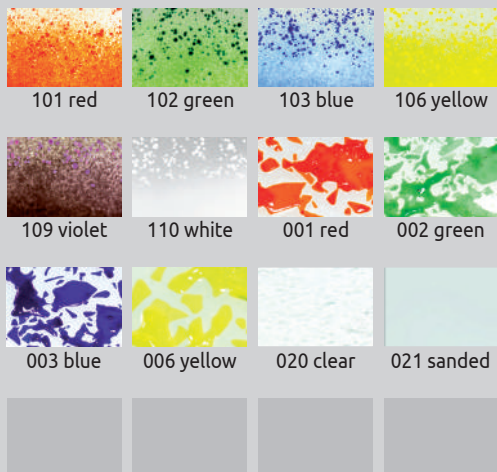

## MÍSY PEARL | PEARL BOWLS

**Kód | Code**   **Rozměr | Size**

	54401xx	ø 15 cm
	54403xx	ø 18 cm
	54405xx	ø 32 cm
	54407xx	ø 36 cm
	54411xx	ø 15 cm   3 cm
	54413xx	ø 18 cm   3 cm
	54415xx	ø 32 cm   3 cm
	54417xx	ø 36 cm   4,5 cm

xx - Dvočíslí určující barvu výrobku  
xx - Number of individual color





## MÍSY SOLO | SOLO BOWLS

## MÍSY CLOD | CLOD BOWLS

**Kód | Code**   **Rozměr | Size**

243700xx   ø 42 cm  
hloubka 11 cm  
depth 11 cm

243701xx   ø 35 cm  
hloubka 8,5 cm  
depth 8,5 cm

243702xx   ø 53 cm  
hloubka 15 cm  
depth 15 cm

xx - Dvojčíslí určující barvu výrobku  
xx - Number of individual color

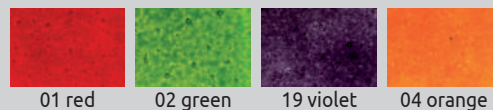

**Kód | Code**   **Rozměr | Size**

55150xx   20 x 12 cm

xx - Dvojčíslí určující barvu výrobku  
xx - Number of individual color

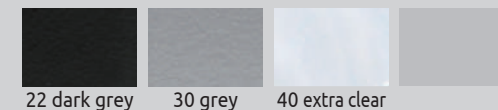



SCHODY A ETAŽÉRY | STEP TRAYS

*Step trays*

*Etažéry*



## RAUTOVÉ SCHODY I. | STEPS I. TRAYS

## RAUTOVÉ SCHODY I. | STEPS I. TRAYS

**Kód | Code**   **Rozměr | Size**

5540018   67 x 40 x 12 cm  
4 stupně | 4 stairs

K rautovým schodům nabízíme skleněné podpěry podle velikosti schodů. Pro bližší informace nás prosím kontaktujte.

For STEPS Trays we also offer special glass supports according to the size of product. We can send further informations on request.



Podpěru je nutné doobjednat zvlášť.  
Support must be ordered separately.

**Kód | Code**   **Rozměr | Size**

5540418   67 x 40 x 12 cm  
4 stupně | 4 stairs

K rautovým schodům nabízíme skleněné podpěry podle velikosti schodů. Pro bližší informace nás prosím kontaktujte.

For STEPS Trays we also offer special glass supports according to the size of product. We can send further informations on request.



Podpěru je nutné doobjednat zvlášť.  
Support must be ordered separately.



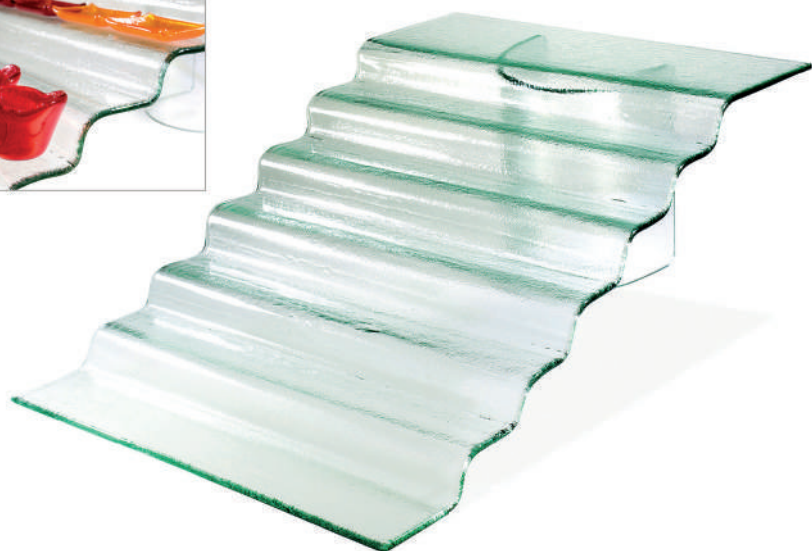

## RAUTOVÉ SCHODY I. | STEPS I. TRAYS

**Kód | Code**   **Rozměr | Size**

540019   65 x 40 x 20 cm  
7 stupňů | 7 stairs

K rautovým schodům nabízíme skleněné podpěry podle velikosti schodů. Pro bližší informace nás prosím kontaktujte.

For STEPS Trays we also offer special glass supports according to the size of product. We can send further informations on request.



Podpěru je nutné doobjednat zvlášť.  
Support must be ordered separately.

## RAUTOVÉ SCHODY I. | STEPS I. TRAYS

**Kód | Code**   **Rozměr | Size**

540419   65 x 40 x 20 cm  
7 stupňů | 7 stairs

K rautovým schodům nabízíme skleněné podpěry podle velikosti schodů. Pro bližší informace nás prosím kontaktujte.

For STEPS Trays we also offer special glass supports according to the size of product. We can send further informations on request.



Podpěru je nutné doobjednat zvlášť.  
Support must be ordered separately.



## RAUTOVÉ SCHODY PYRAMIDA | PYRAMIDA TRAYS

## TÁCKY CANAPÉ I. | CANAPÉ TRAYS I.

**Kód | Code**   **Rozměr | Size**

540x40   40 x 40 cm

x - Číslice určující barvu výrobku  
x - Number of individual color



0 clear   4 dark grey   5 extra clear

K rautovým schodům nabízíme skleněné podpěry podle velikosti schodů. Pro bližší informace nás prosím kontaktujte.

For STEPS Trays we also offer special glass supports according to the size of product. We can send further informations on request.



Podpěru je nutné doobjednat zvlášť.  
Support must be ordered separately.

**Kód | Code**   **Rozměr | Size**

50103xx   10 x 10 cm

xx - Dvojcíslicí určující barvu výrobku  
xx - Number of individual color



01 red   02 green   04 orange   06 yellow



07 beige   08 turquoise   09 pink   11 light green

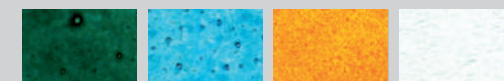

12 dark green   18 light turquoise   37 light amber   20 clear



30 grey   22 dark grey





## RAUTOVÉ SCHODY II. | STEPS II. TRAYS

**Kód | Code**   **Rozměr | Size**

540x21      88 x 48 x 10 cm

x - Číslice určující barvu výrobku  
x - Number of individual color

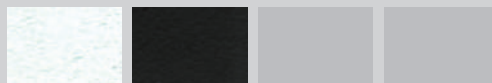

0 clear      4 dark grey

K rautovým schodům nabízíme skleněné podpěry podle velikosti schodů. Pro bližší informace nás prosím kontaktujte.

For STEPS Trays we also offer special glass supports according to the size of product. We can send further informations on request.



Podpěru je nutné doobjednat zvlášť.  
Support must be ordered separately.



## RAUTOVÉ SCHODY II. | STEPS II. TRAYS

**Kód | Code**   **Rozměr | Size**

540x22      83 x 48 x 12 cm

x - Číslice určující barvu výrobku  
x - Number of individual color



0 clear      4 dark grey

K rautovým schodům nabízíme skleněné podpěry podle velikosti schodů. Pro bližší informace nás prosím kontaktujte.

For STEPS Trays we also offer special glass supports according to the size of product. We can send further informations on request.



Podpěru je nutné doobjednat zvlášť.  
Support must be ordered separately.

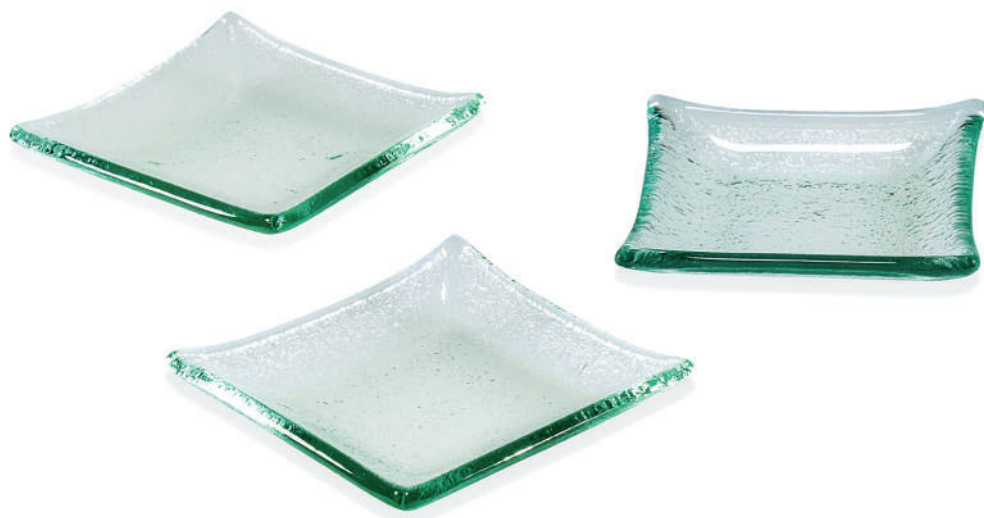

## TÁCKY CANAPÉ IV. | CANAPÉ TRAYS IV.

## TÁCKY CANAPÉ V. | CANAPÉ TRAYS V.

**Kód | Code**    **Rozměr | Size**

53351xx    10 x 10 cm

xx - Dvojcíslní určující barvu výrobku  
xx - Number of individual color



**Kód | Code**    **Rozměr | Size**

50112xx    7 x 7 cm

xx - Dvojcíslní určující barvu výrobku  
xx - Number of individual color





## TÁCKY CANAPÉ II. | CANAPÉ TRAYS II.

**Kód | Code**   **Rozměr | Size**

50101xx   8 x 6 cm

xx - Dvojičísí určující barvu výrobku  
xx - Number of individual color

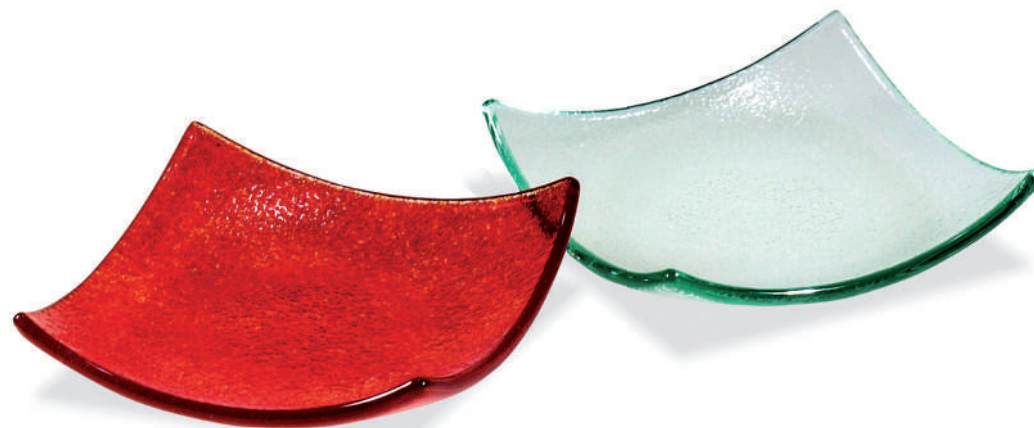

## TÁCKY CANAPÉ VII. | CANAPÉ TRAYS VII.

**Kód | Code**   **Rozměr | Size**

50116xx   10 x 10 cm

xx - Dvojičísí určující barvu výrobku  
xx - Number of individual color





## TÁCKY CANAPÉ VIII. | CANAPÉ TRAYS VIII.

Kód | Code      Rozměr | Size

50117xx      18 x 5 cm

xx - Dvojčíslí určující barvu výrobku  
xx - Number of individual color



## MISKY ALADIN | ALADIN BOWLS

Kód | Code      Rozměr | Size

50133xx      28 x 15 cm

xx - Dvojčíslí určující barvu výrobku  
xx - Number of individual color





## MISKY SOJA | SOJA BOWLS

**Kód | Code**   **Rozměr | Size**

246001xx   ø 6 cm   hloubka 4,5 cm |  
depth 4,5 cm

246002xx   ø 7 cm   hloubka 4,5 cm |  
depth 4,5 cm

xx - Dvojcísli určující barvu výrobku  
xx - Number of individual color



01 red   02 green   03 blue   04 orange



19 violet   20 clear   22 dark grey   30 grey



## MISKY WINKY | WINKY BOWLS

**Kód | Code**   **Rozměr | Size**

50121xx   ø 8 cm   hloubka 3,5 cm |  
depth 3,5 cm

50122xx   8 x 8 cm   hloubka 4 cm |  
depth 4 cm

50123xx   10 x 10 cm   hloubka 5 cm  
| depth 5 cm

xx - Dvojcísli určující barvu výrobku  
xx - Number of individual color



01 red   02 green   04 orange   07 beige

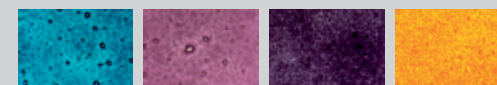

08 turquoise   09 pink   19 violet   36 light amber



30 grey   20 clear





## ETAŽÉR NA DORT | CAKE WHATNOT

## ETAŽÉR VELO | VELO CAKE WHATNOT

### Kód | Code      Rozměr | Size

55125xx      ø 28 cm  
 Výška | hight 7 cm  
 nebo | or  
 výška | hight 12 cm

55126xx      ø 33 cm  
 Výška | hight 7 cm  
 nebo | or  
 výška | hight 12 cm

xx - Dvojcíslní určující barvu výrobku  
 xx - Number of individual color



### Kód | Code      Rozměr | Size

55122xx      ø 22 cm  
 Výška | hight 7 cm  
 nebo | or  
 výška | hight 12 cm

55123xx      ø 28 cm  
 Výška | hight 7 cm  
 nebo | or  
 výška | hight 12 cm

xx - Dvojcíslní určující barvu výrobku  
 xx - Number of individual color





## ETAŽÉR MATIZ | MATIZ CAKE 3-STOREY WHATNOT

**Kód | Code**   **Rozměr | Size**

55121xx   Talíře | Plates:  
30 x 30 cm  
20 x 20 cm  
15 x 15 cm  
Výška | Hight 28 cm

xx - Dvojcíslný určující barvu výrobku  
xx - Number of individual color



## ETAŽÉR VELO | VELO CAKE 3-STOREY WHATNOT

**Kód | Code**   **Rozměr | Size**

55120xx   Talíře | Plates:  
ø 32 cm  
ø 25 cm  
ø 20 cm  
Výška | Hight 30 cm

xx - Dvojcíslný určující barvu výrobku  
xx - Number of individual color



# SVÍCNY | CANDLESTICKS

*Candlesticks* *Svícný*





## SVÍČNY FLOWER | FLOWER CANDLESTICKS

**Kód | Code**   **Rozměr | Size**

61x181      10 x 10 cm

610xxx      10 x 10 cm

x - Číslice určující barvu výrobku  
x - Number of individual color

xxx - Trojčíslí určující barvu výrobku  
xxx - Number of individual color



901 red    902 green    903 blue    904 orange

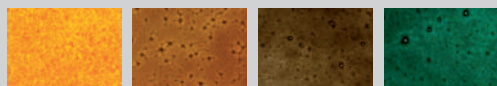

907 light amber    908 amber    909 dark amber    912 dark green



913 light blue    921 silver    920 gold    922 cooper



804 stalactit    803 grosfield    801 krizet



0 clear

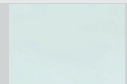

1 sanded



## SVÍČNY FLY | FLY CANDLESTICKS

**Kód | Code**   **Rozměr | Size**

54160xx      34 x 13 cm

xx - Dvočíslí určující barvu výrobku  
xx - Number of individual color



01 red    02 green    04 orange    06 yellow



07 beige    08 turquoise    09 pink    12 dark green

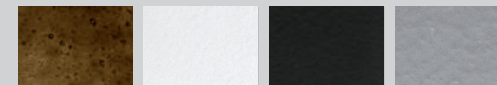

17 brown    10 white    22 dark grey    30 grey



20 clear

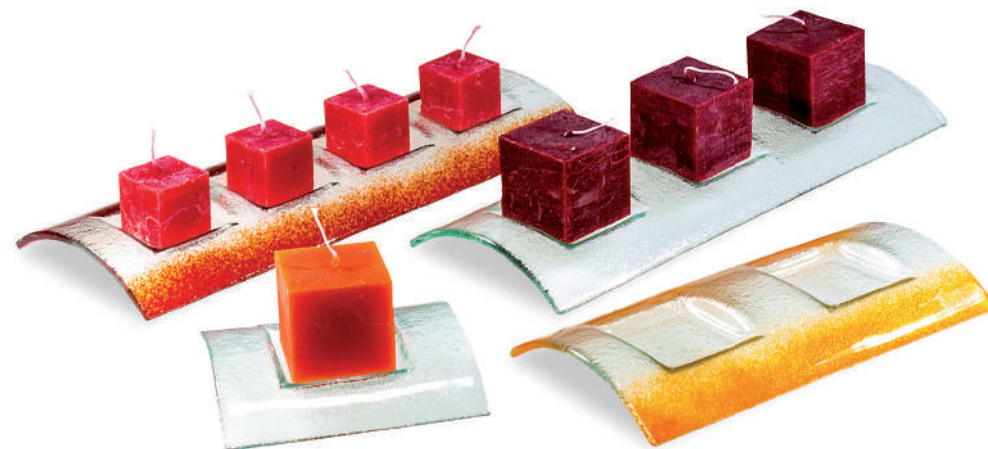

## SVÍCNY FLY LINKY | FLY LINKY CANDLESTICKS

## SVÍCNY TUNNEL | TUNNEL CANDLESTICKS

Kód | Code      Rozměr | Size

54160xx      34 x 13 cm

xx - Dvojčíslí určující barvu výrobku  
xx - Number of individual color



29 extra clear  
with black and  
silver lines

49 grey with  
black and  
silver lines

69 dark grey  
with white  
lines



Kód | Code      Rozměr | Size

65101xx      13 x 13 cm

65102xx      23 x 13 cm

65103xx      34 x 13 cm | 3 svíčky  
3 candles

65104xx      34 x 13 cm | 4 svíčky  
4 candles

xx - Dvojčíslí určující barvu výrobku  
xx - Number of individual color



01 red

02 green

03 blue

04 orange



06 yellow

07 beige

08 turquoise

09 pink

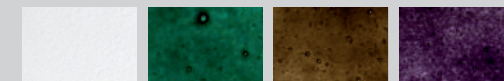

10 white

12 dark green

17 brown

19 violet



20 clear





## SVÍCNY TUNNEL LINKY | TUNNEL LINKY CANDLESTICKS

**Kód | Code**   **Rozměr | Size**

65101xx   13 x 13 cm

65104xx   34 x 13 cm

xx - Dvojičíslo určující barvu výrobku  
xx - Number of individual color



29 extra clear  
with black and  
silver lines

49 grey with  
black and  
silver lines

69 dark grey  
with white  
lines



## SVÍCNY TRIANGLE | TRIANGLE BOWLS

**Kód | Code**   **Rozměr | Size**

53810xx   20 x 20 x 20 cm

xx - Dvojičíslo určující barvu výrobku  
xx - Number of individual color



01 red

02 green

03 blue

04 orange

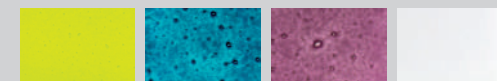

06 yellow

08 turquoise

09 pink

10 white



17 brown

19 dark violet

20 clear

21 sanded



36 light amber



## SVÍCNY TRIANGLE LINKY | TRIANGLE LINKY BOWLS

Kód | Code      Rozměr | Size

53810xx      20 x 20 x 20 cm

xx - Dvojčíslí určující barvu výrobku  
xx - Number of individual color



29 extra clear  
with black and  
silver lines

49 grey with  
black and  
silver lines

69 dark grey  
with white  
lines



## SVÍCNY PALMER | PALMER CANDLESTICKS

Kód | Code      Rozměr | Size

□□□      54188xx      30 x 12 cm

□□□□      54189xx      36 x 12 cm

xx - Dvojčíslí určující barvu výrobku  
xx - Number of individual color



01 red

02 green

03 blue

04 orange

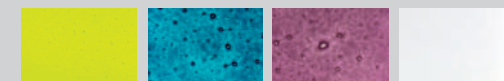

06 yellow

08 turquoise

09 pink

10 white

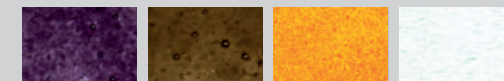

19 violet

17 brown

36 light  
amber

20 clear



30 grey

22 dark grey





## SVÍCNY PALMER | PALMER CANDLESTICKS

**Kód | Code**      **Rozměr | Size**

 54183xx    27 x 10 cm

 54184xx    33 x 10 cm

xx - Dvojcíslný určující barvu výrobku  
xx - Number of individual color



## SVÍCNY LED TUNNEL | LED TUNNEL CANDLESTICKS

**Kód | Code**      **Rozměr | Size**

56036xx      39 x 10 cm

xx - Dvojcíslný určující barvu výrobku  
xx - Number of individual color

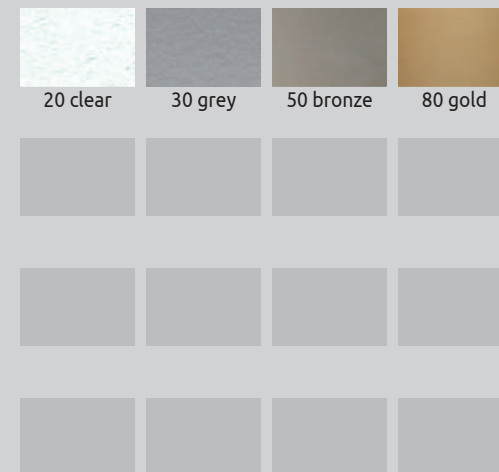

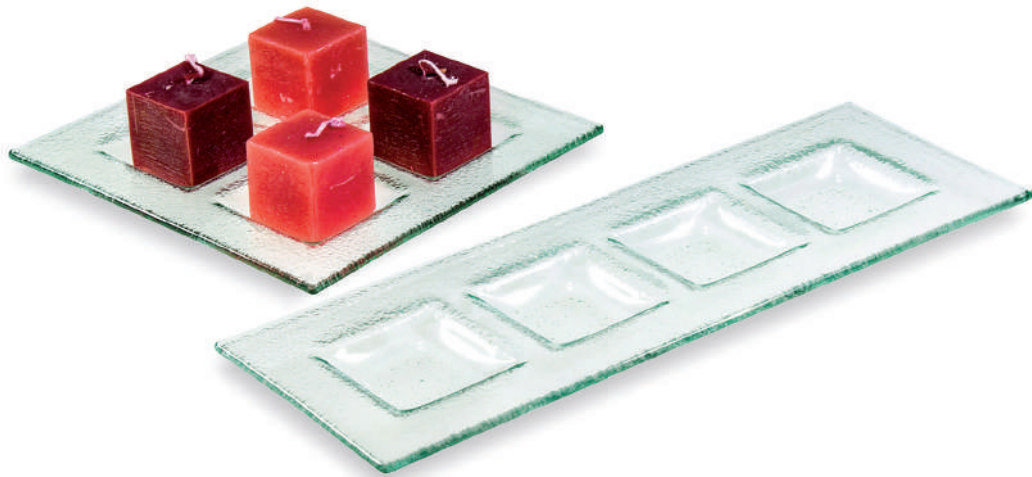

## SVÍCNY ADVENT | ADVENT TRAYS

Kód | Code    Rozměr | Size

5336x1    17,5 x 17,5 cm

5336x2    31,5 x 11 cm

x - Číslice určující barvu výrobku  
x - Number of individual color



0 clear

1 grey



## SVÍCNY BOAT | BOAT CANDLESTICKS

Kód | Code    Rozměr | Size

64011xx    15 x 12 cm

64012xx    24 x 12 cm

64013xx    31 x 12 cm

xx - Dvojčíslí určující barvu výrobku  
xx - Number of individual color



01 red

02 green

03 blue

04 orange

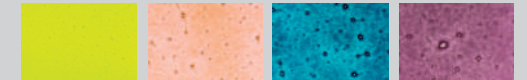

06 yellow

07 beige

08 turquoise

09 pink

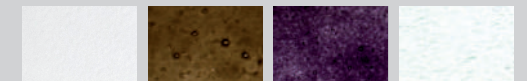

10 white

17 brown

19 violet

20 clear



22 dark grey





## SVÍCNÝ ANGEL | ANGEL CANDLESTICKS

Kód   Code	Rozměr   Size
223010xx	výška   height: 12 cm křídla nahoru   wings up bílé šaty   white dress
223015xx	výška   height: 14 cm křídla dolů   wings down bílé šaty   white dress
223013xx	výška   height: 12 cm křídla nahoru   wings up barevné šaty   color dress
223018xx	výška   height: 14 cm křídla dolů   wings down barevné šaty   color dress

xx - Dvojičíslo určující barvu výrobku  
xx - Number of individual color

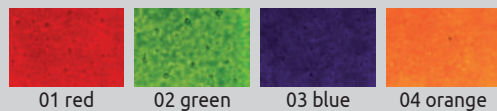

## SVÍCNÝ LEAF | LEAF CANDLESTICKS

Kód   Code	Rozměr   Size
61040xx	8 x 9 cm
61041xx	12 x 17 cm
61042xx	15 x 16 cm
61031xx	18 x 8,5 cm
61030xx	12 x 8,5 cm
61032xx	30 x 10 cm

xx - Dvojičíslo určující barvu výrobku  
xx - Number of individual color

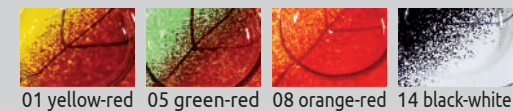



## SVÍČNY FISH | FISH CANDLESTICKS

Kód   Code	Rozměr   Size
61051xx 17 x 8 cm	
61052xx 23 x 9 cm	
61053xx 30 x 10 cm	

xx - Dvojcíslní určující barvu výrobku  
xx - Number of individual color



## SVÍČNY COSMOS | COSMOS CANDLESTICKS

Kód   Code	Rozměr   Size
5248xx	ø 29 cm
5247xx	ø 18 cm

xx - Dvojcíslní určující barvu výrobku  
xx - Number of individual color

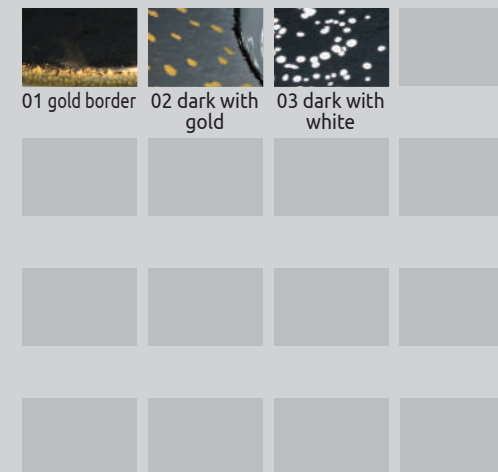



## SVÍCNÝ VLOČKA | SNOWFLAKES CANDLESTICKS

**Kód | Code**    **Rozměr | Size**

51540xx    10 x 10 cm

xx - Dvojičíslo určující barvu výrobku  
xx - Number of individual color



03 dark grey  
with white



04 clear with  
white



## SVÍCNÝ CANDY | CANDY CANDLESTICKS

**Kód | Code**    **Rozměr | Size**

515401xx    10 x 10 cm

xx - Dvojičíslo určující barvu výrobku  
xx - Number of individual color

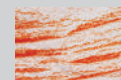

01 red



02 green

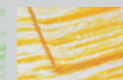

04 orange



08 turquoise



10 white





## SVÍCNÝ LEAF DECAL | LEAF DECAL CANDLESTICKS

Kód   Code	Rozměr   Size
61061xx 16 x 8 cm	
61062xx 19 x 10 cm	
61063xx 28 x 13 cm	

xx - Dvojčíslí určující barvu výrobku  
xx - Number of individual color

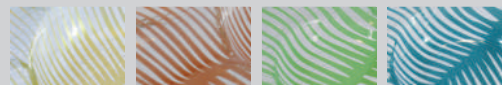

01 gold 02 african brown 03 green 04 turquoise



## 4-POZICOVÉ SVÍCNÝ FLY | 4 POSITION FLY CANDLESTICKS

Kód   Code	Rozměr   Size
54162xx	38 x 13 cm

xx - Dvojčíslí určující barvu výrobku  
xx - Number of individual color



29 extra clear with black and silver lines 49 grey with black and silver lines 69 dark grey with white lines 50 clear with colored spots



60 grey with colored spots





DEKORACE | DECORATIONS  
*Decorations* *Dekorace*



## DEKORATIVNÍ ANDĚLÉ | DECORATIVE ANGELS

Kód   Code	Rozměr   Size
111300100	12 x 20 cm - A
111300300	13 x 25 cm - C

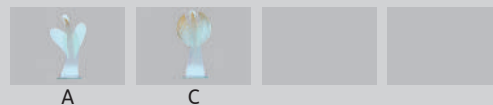

## DEKORATIVNÍ KOČKY | DECORATIVE CATS

Kód   Code	Rozměr   Size
11101x1	16 x 8 cm - A
11101x2	20 x 12 cm - B
11101x3	13 x 14 cm - C
11101x4	10 x 14 cm - D
11101x5	8 x 22 cm - E
11101x6	8 x 20 cm - F

x - Číslice určující barvu výrobku  
x - Number of individual color

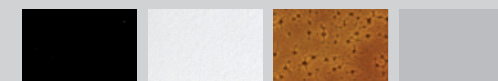

0 black

5 white

7 amber



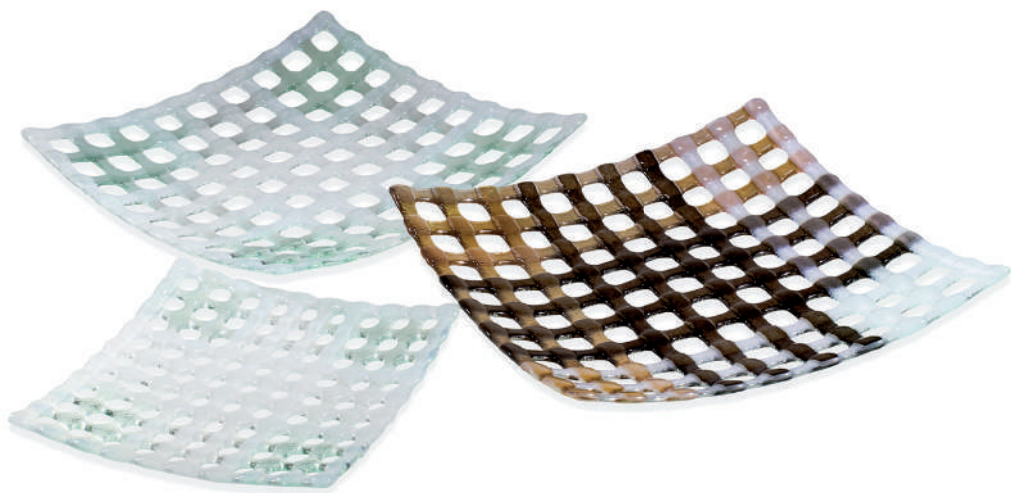

## MÍSY NET | NET BOWLS

Kód | Code    Rozměr | Size

5082xx    20 x 20 cm

5083xx    30 x 30 cm

xx - Dvojičíslo určující barvu výrobku  
xx - Number of individual color

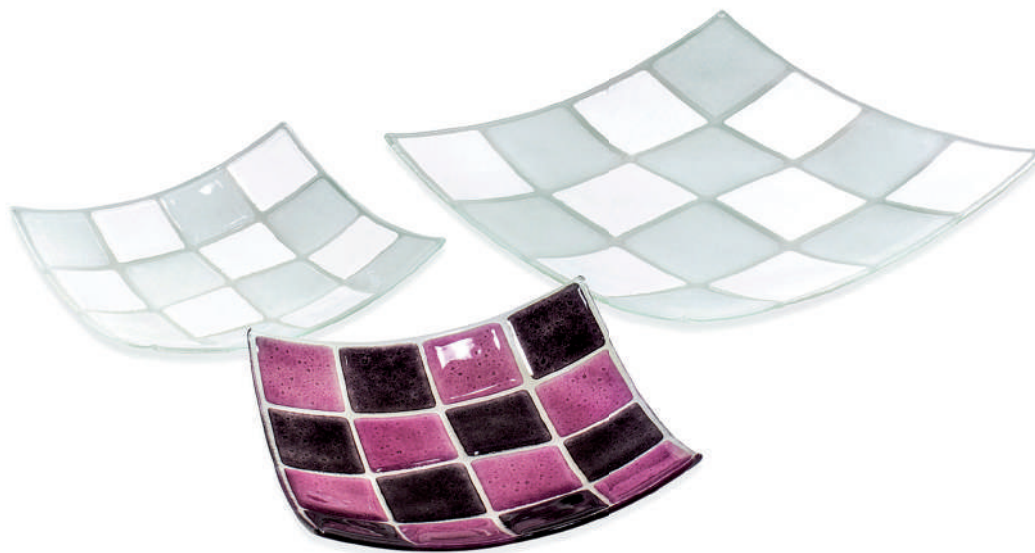

## MÍSY KARO | KARO BOWLS

Kód | Code    Rozměr | Size

5143xx    15 x 15 cm

5142xx    20 x 20 cm

5141xx    30 x 30 cm

xx - Dvojičíslo určující barvu výrobku  
xx - Number of individual color

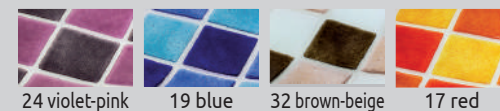



## Barevný vzorník BDK-GLASS | Range of colors in BDK-GLASS production

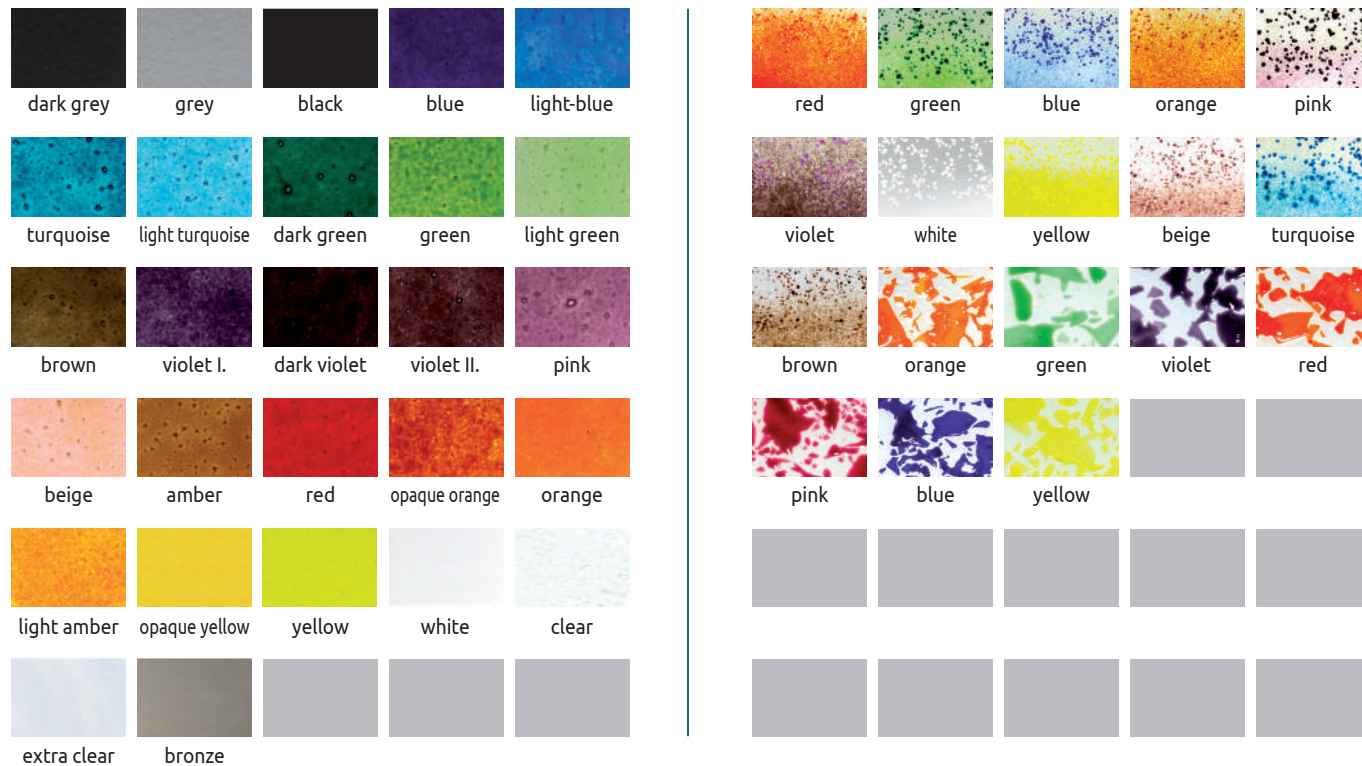

Barvy skla: dark grey (tmavě šedá), grey (šedá), clear (čirá), extra clear (extra čirá) a bronze (bronzová) jsou barevné ve hmotě. Ostatní barvy jsou pouze skleněné frity a lze je tedy použít k dekorování i částí výrobků (například okraje apod.).

Dark grey, grey, clear, extra clear and bronze colors are stained glass in the mass. Other colors are glass frits (powders) and can be used also partly on the product (for example on the rim only).

# Technologie lehaného skla | Technology fusing





**Kontakt:**

BDK-GLASS, spol. s r.o.

Ed. Karla 72 | 503 03 Smiřice | Czech Republic

Tel.: +420 495 421 271

E-mail: [bdk@bdk.cz](mailto:bdk@bdk.cz) | [www.bdk.cz](http://www.bdk.cz) | [www.krasne-sklo.cz](http://www.krasne-sklo.cz)