

CAMBRO®

Catalog 2025 English Metric Europe

TRUSTED DURABILITY

www.cambro.com

TABLE of CONTENTS

EQUIPMENT



INSULATED TRANSPORT

8



MERCHANDISING

65



WAREWASHING

88



CAMSHELVING®

117



SHELVING UTILITY

154

Multi-Functional Box
10

Cam GoBoxes®
12

Insulated Food Servers
(Non-Electric)
35

Camchiller®, Thermobarrier®
& Camwarmer®
37

Temperature Maintenance
38

Transporter Capacity Guide
39

Insulated Front Loaders
40

Ultra Camcarts®
43

Camcarts®
45

Insulated Food Servers
(Electric)
47

Insulated Beverage
Containers
59

Beverage Service Cart
61

Handwashing Stations and
Accessories
62

CVC75 Mobile Food
Vending Cart
65

Versa Food Service System
68

Food Bar Accessories
71

Table Top Food Bars
72

CamKiosk® System
73

Hand Sink Cart
75

Camcruiser® Vending Carts
76

Flex Station
78

Versa Organizers
81

Portable CamBars®
82

Ice Caddies
87

PERSONALIZATION

CVC75

66

CamKiosks®
74

Camcruisers®
76

Camrack® 4-in-1 System
88

Sizing & Reference Guide
94

Camdollies®
103

Tray & Dish/Silver Cart
106

R-Series Adjustable
Dish Caddies
107

S-Series Adjustable
Dish Caddies
108

Cambox® Bus Boxes
113

Service Cart Pro
114

KD Service Cart &
KD Utility Cart
116

PERSONALIZATION

Camracks
101

Key Features
118

Buyers Guide
120

Free Design Service
121

Overall Length —
Quick Reference Guide
122

Camshelving Premium®
Series
124

Premium Series Weight
Bearing Chart
125

Premium Series
Configurations
128

Premium Series Accessories
130

High Density Storage System
131

Camshelving Elements®
XTRA Series
136

Elements XTRA Series
Weight Bearing Chart
137

Elements XTRA Series
Configurations
139

Elements XTRA Series
Accessories
141

Camshelving Basics® Plus
Series
144

Basics Plus Series
Weight Bearing Chart
145

Basics Plus Series
Configurations
147

Basics Plus Series
Accessories
151

Camshelving® Wine Rack
154

Universal Storage Rack
156

Camshelving Ultimate
#10 Can Rack System
157

The Ultimate Sheet Pan Rack
160

GN Food Pan Trolley
162

Pan Stops
164

Full Size Covers
164

Premium Series
Full-Wrap Security Cage
165

Drying and Storage Rack
165

Elements Series 2-Shelf
Vented Undercounter Units
167

Wall Shelves and Shelf
Extenders
168

Dunnage Racks
169

Camlink®
169

SUPPLIES



STORAGE 170

- Food Storage Square Containers 170
- Food Storage Round Containers 182
- Food Storage Boxes & Lids 186
- StoreSafe® Labels 190
- Camwear® Food Pans & Lids 191
- H-Pans™ High Heat Pans 195
- High Heat H-Pan™ with Handle(s) 199
- Translucent Food Pans 200
- ColdFest® 203
- Pizza Dough Boxes 204
- Ingredient Bins & Scoops 205
- Soak and Brine Tank & Camcrisper® 206
- High Heat Measuring Cups & Camwear® Measuring Cups 207

PERSONALIZATION

- CamSquare 180



TABLE SERVICE 208

- Dinnerware 209
- Camcovers® 210
- Pitchers 212
- Lido® Tumblers 213
- Camwear® Tumblers 213
- Huntington® and Newport Tumblers 214
- Laguna® and Del Mar® Tumblers 215
- Colorware Tumblers 216
- Dessert Glass 216
- Camliter® 217
- Beverage Dispenser, Pail With Bail & Swirl Bowls® 218
- Wine Buckets and Bud Vase 219

PERSONALIZATION

- Dessert Glass, Tumblers, Camliters, Pitchers, and Wine Buckets 211



DISPLAY 220

- Deli Crocks & Platter 220
- Showfest® Display Bowls 221
- Camwear® Bowls 222
- Display Covers & Trays 225
- Crocks & Ladles 226
- Serving Spoons, Camtensils® & Turners 227
- Lugano® Tongs 228
- Shakers/Dredges & Condiment Jars 229

PERSONALIZATION

- Shakers 229



TRAYS 230

- Choose the right tray 230
- Tray Product Guide 233
- Century™ Trays 238
- Polyester Versa Trays 240
- Versa Lite Trays 243
- Camtrays® 247
- EpicTread™ Trays 251
- Dietary & Camlite® Trays 252
- Camwear® Trays 253
- Camtread® Trays 254
- Treadlite™ & Polytread Trays® 256
- Wood Trays 258
- Corfu, Capri, Mykonos, & Madeira Trays 258
- Fast Food Trays 263
- Compartment Trays 264
- Market Trays & Pans 268

PERSONALIZATION

- Camtray 231
- Camtread Trays 232
- Fast Food Trays 263

HEALTHCARE



HEALTHCARE 269

- Camduction® Complete Heat System 269
- Meal Delivery Ware 272
- Reusable CamLids® for Meal Delivery Systems 275
- Camrack® Wash and Store Rack 275
- Camshelving® Hygienic Drying Racks 276
- Tablotherm 278
- Versa Trays 282
- Non-Slip Versa Trays 283
- Camtrays® with Handles & Camwear Non-Slip Tray 286
- Meal Delivery Carts 287
- Roto Color Chart 293

The Trademarks of Cambro and product images are the property of Cambro and are subject to the control and ownership of Cambro. Any use thereof is only granted for the promotion and sales of Cambro products and subject to the control of Cambro Manufacturing Company.

New Product Introduction



The Pro Cart Ultra Pan Carriers

CamGoBox®



Camshelving® Universal Storage Rack



Pro Cart Ultra Stainless Steel GN Pan Carrier



Cambro Mobile Food Vending Cart



**Camshelving
Elements XTRA Series**



Camshelving® Wine Rack



**Camshelving
GN Food Pan
Trolleys**



**Pan
Stop**



CamSquares® FreshPro

**Translucent
CamSquares®
0,47 and 0,95L**



Service Cart Pro



**Camliter® with
Flip Lid**



Meal Delivery Cart





the Cambro® story

When William and Argyle Campbell first opened the doors at Cambro Manufacturing in 1951, their goal was to make the highest quality hospital meal tray possible. Named the Camtray, it demonstrated that they were as committed to excellence in the foodservice industry as they were with their own products. As 2025, marked the company's 74th year of leadership in quality, innovation and customer service, today Cambro serves the world with the industry's most complete selection of products for widely diverse segments of the foodservice business. The future is certain to bring great changes to our industry. Yet one thing that will remain a constant is Cambro's tradition of continually developing new products that help foodservice operators save time and money, increase sales, reduce labor and improve service. In the years ahead, guided by the commitment of its founders to innovation, quality, and value, Cambro Manufacturing will still be the leader in serving the foodservice industry and you, our valued customer.

ICON DIRECTORY

Throughout the Cambro catalog, please use the following easy-to-identify icons to help explain Cambro product features or services.



Food Safety Matters

For 70 years, Cambro foodservice equipment and supplies have earned the trust and loyalty of customers and public health professionals alike because our products are designed with Food Safety in mind. At Cambro, every product design is based upon the core principle of food safety.

Look for the Cambro StoreSafe mark throughout the Cambro catalog to identify Cambro storage and transportation products that support safe food handling.

You can learn more about Cambro's Food Safety initiatives at www.cambro.com/storesafe



Many Cambro products may be recycled. For further information, please contact your Cambro representative.



Listed by NSF International, an independent, not-for-profit organization which certifies products that meet their criteria for sanitation and cleanability.



Cambro "Storage Select" BPA-Free (Bisphenol-A Free) products are available for customers who are interested in products deemed BPA-Free. Please contact your sales representative for more information.



Certifies products by Technischer Überwachungs-Verein. (Technical Inspection Association)



Fit for Food Products



New Product



Personalization Available Non-Food Contact Areas Only.



Dishwasher Safe



Stackable



Foam Insulation



Pro-Rated Warranty



Not For Use In Heated Carts



One carton of product is within the weight and cube requirements to be shipped by parcel carrier.

www.cambro.com

Visit www.cambro.com for a wide variety of information about our products, including new product updates, an interactive Camrack Glass to Rack Guide, consultant cut sheets and CAD drawings, care and maintenance product guides and more.



Ready to Deliver

Cambro offers the widest variety of delivery equipment options in the industry. We'll help you design the optimal system to grow your delivery business while maintaining the food safety, flavors and textures that built your loyal following.

Food Safety and Quality

From the time the food is prepped to the moment it reaches the customer's doorstep, every second counts. Keep food safely hot or cold every step of the way.

- At-counter holding for pick-up or takeout.
- Curbside pick-up.
- Delivery.

Employee Safety

High-tech materials and ergonomic design reduce the load for employees.

- Lightweight options.
- Secure carrying straps.
- Dollies for large catering orders.

Icon Directory



Lightweight – Made of EPP (Expanded Polypropylene) an eco friendly high performance insulation material.



Chemically Inert – unaffected by oil, grease and most chemicals.



Excellent Energy Absorption – can withstand substantial impact without damage.



Great Structural Strength – capable of handling significant loads while maintaining its shape and form.



Dishwasher safe.



Safe for food contact.



100% Recyclable.

CAM GOBOX® PROFESSIONAL GRADE INSULATED CARRIERS



Made of Expanded Polypropylene (EPP), an eco-friendly, high performance insulation material, Cam GoBoxes are incredibly lightweight, making delivery easy.

- Hold safe temperatures over four hours.
- Great for holding for pick-up.
- Good for multiple stops or large events.
- Stackable.
- Most economical option.



CAMBRO® GOBOX®

Multi-Functional Box

ONE
SYSTEM

Endless
Possibilities

4+ HOURS
of Temperature Retention



Take your business to new heights with 10 cm or 20 cm extenders.

Flip over lid and extender for easy loading with larger or heavier items like wedding cakes.



MORE
INFG 

Store
Safe 

CAMBRO® GOBOX® MULTI-FUNCTIONAL BOX



One System, Endless Possibilities!



EPPMFB	
LID	1 EA
BASE	1 EA
EXTENDER 10 cm	—
EXTENDER 20 cm	—



EPPMFBE1	
LID	1 EA
BASE	1 EA
EXTENDER 10 cm	1 EA
EXTENDER 20 cm	—



EPPMFBE2	
LID	1 EA
BASE	1 EA
EXTENDER 10 cm	—
EXTENDER 20 cm	1 EA



EPPMFBE12	
LID	1 EA
BASE	1 EA
EXTENDER 10 cm	1 EA
EXTENDER 20 cm	1 EA



EPPMFBE22	
LID	1 EA
BASE	1 EA
EXTENDER 10 cm	—
EXTENDER 20 cm	2 EA



EPPMFBE122	
LID	1 EA
BASE	1 EA
EXTENDER 10 cm	1 EA
EXTENDER 20 cm	2 EA

CODE	INT. DIMENSIONS W x L x H	EXT. DIMENSIONS W x L x H
EPP Multi-Functional Box		
EPPMFB	52 x 52 x 12,5 cm	64,1 x 64,1 x 25,4 cm
EPPMFBE1	52 x 52 x 25,2 cm	64,1 x 64,1 x 35,4 cm
EPPMFBE2	52 x 52 x 35,2 cm	64,1 x 64,1 x 45,4 cm
EPPMFBE12	52 x 52 x 45,2 cm	64,1 x 64,1 x 55,4 cm
EPPMFBE22	52 x 52 x 65,2 cm	64,1 x 64,1 x 65,4 cm
EPPMFBE122	52 x 52 x 75,2 cm	64,1 x 64,1 x 75,4 cm
Accessories		
EPPMFE1	10 cm Extender	64,1 x 64,1 x 10 cm
EPPMFE2	20 cm Extender	64,1 x 64,1 x 20 cm
EPPID5	Plastic ID Labels	—
CP2632	1/2 size Camchiller®	26,5 x 32,5 x 3 cm
HP2632	1/2 size Camwarmer®	26,5 x 32,5 x 3 cm
FR258	Full Flatware Rack	Inside height: 6,7 cm Outside height: 10,1 cm
EPP Adapter Only		
EPPMFBA	—	69,80 x 62,21 x 7,04 cm
CD4060 Dolly + EPP Adapter		
EPPMFBAPKG	—	—

Multi-Functional Box Case Pack: 1 EPPMFBAPKG Dolly + Adapter Case Pack: Ships in 2 boxes Lid and Base Color: Black (110).
 Extender Color: Gray (107). Camchiller Color: Glacier Blue (443). Camwarmer Color: Fire Red (444). Flatware Rack Color: Soft Gray (151).



CAM GOBOX® PROFESSIONAL GRADE INSULATED CARRIERS

GN Top Loaders

GN Top Loader – Large Handles

A BUILT-IN LABEL AREA

Keeps optional plastic menu tags in place for easy content identification or routing. StoreSafe® Labels can also be used with Cam GoBoxes.

OPTIONAL INSERT KIT

For an additional cold boost, use with optional Camchiller® Insert Kit EPPCTLPKG. Built-in cut-outs support cold transfer while protecting food from condensation.



CAM GOBOXES
Inter-stack and also stack with major competitive brands.

ERGONOMIC HANDLES
Comfortable handles allow easy and safe lifting of the EPP180LH GoBox.

LINE YOUR CAM GOBOX

With a Cambro GN Food Pan and Seal Cover for the ultimate food safety solution. Cambro GN pans protect food and carrier to support HACCP compliance.

EASY LOADING AND UNLOADING

Interior wall recesses make loading and unloading easy for both GN 1/1 as well as GN 1/2 Food Pans. Straight interior walls allow room for stacking pans inside carrier.



CAM GOHEAT™

Warms to 75°C in just 10 minutes after plugging in. Place in the bottom of your insulated carrier or use to hold or display hot foods on a table top, counter or buffet.

TEMPERATURE RETENTION
4+ hours



CAM GOBOX® PROFESSIONAL GRADE INSULATED CARRIERS— GN TOP LOADERS

For Half-Size (GN 1/2) Food Pans



EPP260

Holds 1 each 15 cm deep food pan*

EXTERIOR: L 39 x W 33 x H 25,7 cm

INTERIOR: L 33 x W 27 x H 19,3 cm

UNIT WEIGHT: 0,62 kg

VOLUME: 16,9 L

Case Pack: 1 Color: Black (110).



EPP280 without Strap

Holds 1 each 20 cm deep food pan*

EXTERIOR: L 39 x W 33 x H 31,6 cm

INTERIOR: L 33 x W 27 x H 25,3 cm

UNIT WEIGHT: 0,7 kg / 0,8 kg with strap

VOLUME: 22,3 L

Case Pack: 1 Color: Black (110).



EPP280BKST with Black Strap

EPP280RDST with Red Strap

Holds 1 each 20 cm deep food pan*

EXTERIOR: L 39 x W 33 x H 31,6 cm

INTERIOR: L 33 x W 27 x H 25,3 cm

UNIT WEIGHT: 0,7 kg / 0,8 kg with strap

VOLUME: 22,3 L

Case Pack: 1 Color: Black (110).

For Full-Size (GN 1/1) or Half-Size (GN 1/2) Food Pans



EPP140

Holds 1 each 10 cm deep food pan*

EXTERIOR: L 60 x W 40 x H 20,7 cm

INTERIOR: L 53,8 x W 33,8 x H 14,5 cm

UNIT WEIGHT: 0,91 kg

VOLUME: 26 L

Case Pack: 1 Color: Black (110).



EPP160 / EPP160CL with Color Lid

Holds 1 each 15 cm deep food pan*

EXTERIOR: L 60 x W 40 x H 25,7 cm

INTERIOR: L 53,8 x W 33,8 x H 19,5 cm

UNIT WEIGHT: 1,07 kg

VOLUME: 35,5 L

Case Pack: 1 EPP160 Lid Color: Black (110).

EPP160CL Lid Colors: Red (365), Orange (363), Yellow (361), Green (360), Blue (362).

EPP180 / EPP180CL with Color Lid

Holds 1 each 20 cm deep food pan*

EXTERIOR: L 60 x W 40 x H 31,6 cm

INTERIOR: L 53,8 x W 33,8 x H 25,4 cm

UNIT WEIGHT: 1,2 kg

VOLUME: 46 L

Case Pack: 1 EPP180 Lid Color: Black (110).

EPP180CL Lid Colors: Red (365), Blue (362).



EPP180S

Holds 1 each 20 cm deep food pan*

EXTERIOR: L 60 x W 40 x H 31,6 cm

INTERIOR: L 53,8 x W 33,8 x H 25,4 cm

UNIT WEIGHT: 1,13 kg

VOLUME: 43 L

Case Pack: 1 Color: Black (110).



EPP180XLT

Holds 1 each 20 cm deep food pan*

EXTERIOR: L 61 x W 43,1 x H 39,1 cm

INTERIOR: L 54,8 x W 36,8 x H 32 cm

UNIT WEIGHT: 1,45 kg

VOLUME: 64,5 L

Case Pack: 1 Color: Black (110).



EPP180LH

Holds 1 each 20 cm deep food pan*

EXTERIOR: L 68 x W 40 x H 32,1 cm

INTERIOR: L 53,8 x W 35,5 x H 25,5 cm

UNIT WEIGHT: 1,2 kg

VOLUME: 46 L

Case Pack: 1 Color: Black (110).

*Or equivalent

CAM GOBOX® PROFESSIONAL GRADE INSULATED CARRIERS— GN FRONT LOADERS



DRIP-RESISTANT
Built-in condensation barrier helps front loaders to remain drip-resistant.



4-SIDED HANDLING
Thoughtfully designed built-in handles along the top of front loading models allow them to be easily carried from all four sides.

A BUILT-IN LABEL AREA
Keeps plastic menu tags (included with EPP300 and EPP400) in place for easy content identification or routing. StoreSafe® labels can also be used with Cam GoBoxes.

GENTLE OPEN AND CLOSE
Beveled door edges ensure door can be easily closed and latched. Durable latches for long term use.



FULL 270° ACCESS
Durable hinges and latches allow the door to open 270° and remain open securely to the side of the front loader for easy access to products. Latches keep door securely closed during transport.



STACKABILITY
Cam GoBoxes inter-stack.

TEMPERATURE MAINTENANCE TOOLS
Cam GoBox front loading carriers are designed with enough room to hold GN 1/1 Food Pans along with a Camwarmer® or Camchiller®, if desired.

TEMPERATURE RETENTION
4+ hours



Note: Best results will be achieved by loading food pans between 82° to 88°C. Loading metal food pans over 120°C will result in damage to the carrier.

CAM GOBOX® PROFESSIONAL GRADE INSULATED CARRIERS

GN FRONT LOADERS

For Full-Size (GN 1/1)
Food Pans



EPP300

Holds 3 each 10 cm deep food pan*

EXTERIOR: L 64 x W 44 x H 47,5 cm

INTERIOR: L 53,5 x W 33 x H 37 cm

UNIT WEIGHT: 3,2 kg

VOLUME: 60 L

Case Pack: 1 Color: Black (110).



EPP400

Holds 4 each 10 cm deep food pan*

EXTERIOR: L 64 x W 44 x H 62,5 cm

INTERIOR: L 53,5 x W 33 x H 52,5 cm

UNIT WEIGHT: 3,9 kg

VOLUME: 86 L

Case Pack: 1 Color: Black (110).

*Or equivalent

**STOCK PRODUCTS & COLORS AVAILABLE
IN OUR EUROPEAN WAREHOUSE**

ALL CAM GOBOXES

CAM GOBOX® CAPACITY GUIDE

EPP140 (GN 1/1) EPP160 (GN 1/1) & EPP260 (GN 1/2)

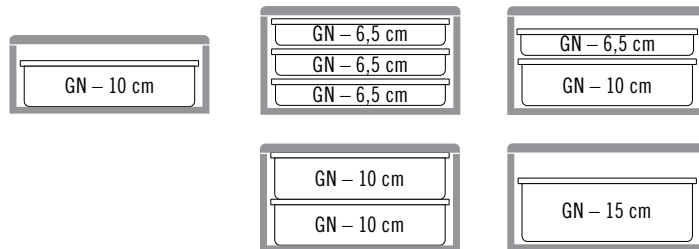

EPP180 (GN 1/1) & EPP280 (GN 1/2)

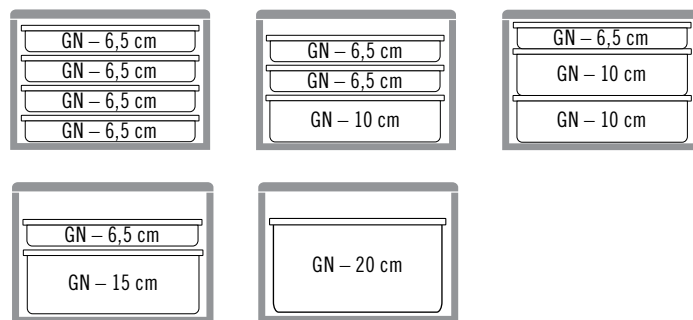

EPP180S

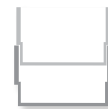
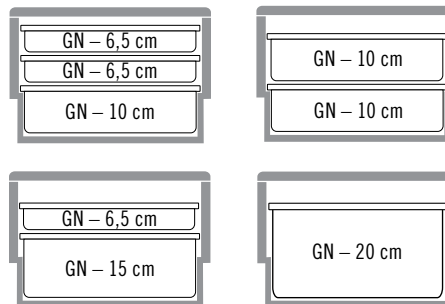

Unique design allows
inter-stacking, saving
30% storage space.

EPP300 (GN 1/1)

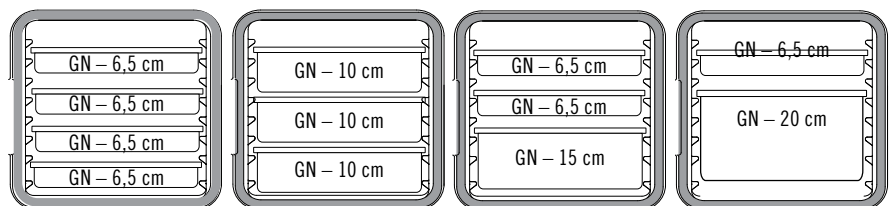

EPP400 (GN 1/1)

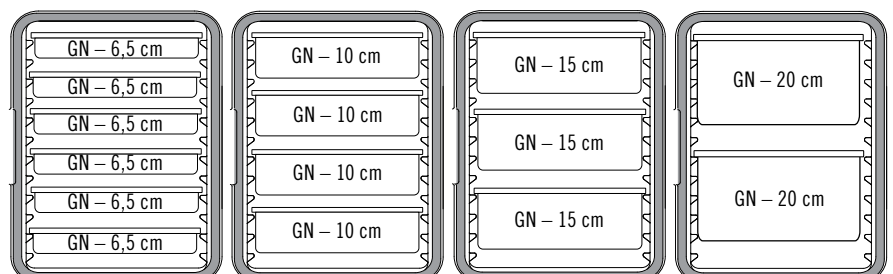

CAM GOBOX® GN ACCESSORIES

STOCK PRODUCTS & COLORS AVAILABLE
IN OUR EUROPEAN WAREHOUSE

ALL CAM GOBOX GN ACCESSORIES

Camchillers®

Camchillers (Cold plates) are designed to extend the cold holding time of your food. Simply freeze flat overnight and place at the top of your carrier.



CP3253

Camchiller GN 1/1 for EPP140, EPP160, EPP160CL, EPP180, EPP180CL, EPP180LH, EPP300, EPP400

L 53 x W 32,5 x H 3 cm

UNIT WEIGHT: 3,9 kg

Case Pack: 1 Color: Glacier Blue (443).



CP2632

Camchiller GN 1/2 for EPP260, EPP280, EPP280BKST, EPP280RDST

L 32,5 x W 26,5 x H 3 cm

UNIT WEIGHT: 1,75 kg

Case Pack: 1 Color: Glacier Blue (443).

Camwarmers®

Camwarmers (Hot plates) are designed to extend the hot holding time of your food. Place in a hot water bath for 40 minutes and place at the bottom of your carrier.



HP3253

Camwarmer GN 1/1 for EPP140, EPP160, EPP160CL, EPP180, EPP180CL, EPP180LH, EPP300, EPP400

L 53 x W 32,5 x H 3 cm

UNIT WEIGHT: 3,9 kg

Case Pack: 1 Color: Fire Red (444).



HP2632

Camwarmer GN 1/2 for EPP260, EPP280, EPP280BKST, EPP280RDST

L 32,5 x W 26,5 x H 3 cm

UNIT WEIGHT: 1,75 kg

Case Pack: 1 Color: Fire Red (444).

Camchiller Inserts

Built-in cut-outs support cold transfer while protecting food from condensation.



EPPCTS

Camchiller Insert for Standard EPP140, EPP160, EPP160CL, EPP180, EPP180CL, EPP180LH, EPP300, EPP400

EXTERIOR: L 60 x W 40 x H 8,7 cm

INTERIOR: L 53,7 x W 33,7 x H 3,4 cm

UNIT WEIGHT: 0,37 kg

Case Pack: 1 Color: Black (110).



EPPCTL

Camchiller Insert for EPP180LH

EXTERIOR: L 68 x W 40 x H 8,7 cm

INTERIOR: L 53,7 x W 33,7 x H 3,4 cm

UNIT WEIGHT: 0,37 kg

Case Pack: 1 Color: Black (110).

Cam GoHeat™

Warms to 75°C in just 10 minutes after plugging in. Place in the bottom of your insulated carrier or use to hold or display hot foods on a table top, counter or buffet.



CGH100WUK 100W, 230V* UK

CGH200WUK 200W, 230V* UK

CGH100WEU 100W, 230V* EU

CGH200WEU 200W, 230V* EU

CGH1W12VCAR 100W, 12V - 14,2V Auto

L 49,5 x W 28,5 x H 1,2 cm

UNIT WEIGHT: 1,1 kg

Case Pack: 1 Color: Silver (486).

*220-240 volt alternating current.

Camchiller Insert Kits



EPPCTSPKG110

Standard top loader Camchiller and Insert all in one package, available for EPP180 and EPP160.



EPPCTLPKG110

Large handle Camchiller and Insert all in one package, available for EPP180LH.

ThermoBarrier®

Designed to keep hot or cold air concentrated within your front-loading carrier. As food pans are being removed, use the ThermoBarrier to close up any open space created.



EPP3253DIV

ThermoBarrier fits EPP300 and EPP400

L 53 x W 32,7 x H 3,7 cm

UNIT WEIGHT: 0,37 kg

Case Pack: 1 Color: Black (110).

CAM GOBOX® GN ACCESSORIES

Cam GoBox Rail Board and Divider

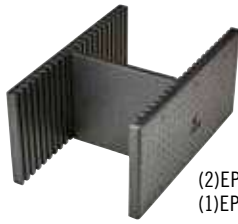

(2)EPP180RB +
(1)EPP180RBD



EPP180RB

Rail Board for EPP180

L 53,8 x W 25,4 x H 32,8 cm

UNIT WEIGHT: 3,9 kg

Case Pack: 1 Color: Black (110).

EPP180RBD

Divider for EPP180

L 30,6 x W 26,5 x H 1,9 cm

UNIT WEIGHT: 1,75 kg

Case Pack: 1 Color: Black (110).

Color Lids

Use lids to color code for quick content identification or routing.



EPP3253LID

Color lid for EPP140, EPP160, EPP160CL, EPP180, EPP180CL, EPP180S

L 60 x W 40 x H 3,4 cm

UNIT WEIGHT: 0,28 kg

Case Pack: 1 Colors: Cambro Red (365), Cold Blue (362), Black (110).

Cam GoBox GN Extender



EPPEXT

10 cm extender fits all GN 1/1 Top Loaders

EXTERIOR: L 59,4 x W 39,9 x H 9,9 cm

INTERIOR: L 53,8 x W 33,8 cm

UNIT WEIGHT: 0,24 kg

Case Pack: 1 Color: Black (110).



Add 10 cm to your top loader GoBox to fit oversized items.

Camdolly®



CD3253EPP

Camdolly fits GN 1/1 Cam GoBoxes 4 swivel casters, 2 with brake

EXTERIOR: L 69,2 x W 42,6 x H 16,7 cm

INTERIOR: L 61,8 x W 41 cm

UNIT WEIGHT: 4,5 kg

LOAD CAPACITY: 250 kg

OPTIONAL TRANSPORTING STRAP: 400STP, 381 cm long strap

Case Pack: 1 Camdolly Color: Hot Red (158). 400STP Color: Beige (000).

Flip Lid

The Flip Lid offers easy access while reducing points of cross-contamination.



EPPFLID

Flip Lid fits EPP140, EPP160/160CL, EPP180/180CL/180LH/180S

EXTERIOR: L 60 x W 40 x H 31,6 cm

INTERIOR: L 53,8 x W 33,8 x H 25,4 cm

UNIT WEIGHT: 1,2 kg

Case Pack: 1 Color: Black (110).

Plastic ID Labels



EPPID5

Plastic ID labels fits all Cam GoBoxes

Case Pack: 1 Color: (000).

**STOCK PRODUCTS & COLORS AVAILABLE
IN OUR EUROPEAN WAREHOUSE**

ALL CAM GOBOX ACCESSORIES

CAM GOBOX® 4060 PROFESSIONAL GRADE INSULATED CARRIERS— MULTI-PURPOSE FRONT LOADER – 60 X 40 CM

STACKABILITY

Cam GoBoxes inter-stack and also stack with major competitive brands.

EASY IDENTIFICATION

A built-in label area keeps plastic menu tags in place for easy content identification or routing. Dissolvable StoreSafe® Labels can also be used with Cam GoBoxes.

FULL 270° ACCESS

Durable hinges and latches allow the door to open 270° and remain open securely to the side of the front loader for easy access to products. Latches keep door securely closed during transport.



4-SIDED HANDLING

Thoughtfully designed, built-in handles along the top of the front loader units allow them to be easily carried from all four sides.

UNIQUE DESIGN

Compartment for cold chiller plate or hot plate is located on the inner back wall to prevent overhead condensation drips and to evenly distribute temperature throughout the carrier.

GENTLE OPEN AND CLOSE

Beveled door edges ensure door can be easily closed and latched. Durable latches for long term use.

DRIP-RESISTANT

Built-in condensation barrier helps front loaders to remain drip-resistant.



Front Loaders With Built-In Rails

Front-loading carriers with built-in rails are designed to hold 60 x 40 cm pans, sheet pans and trays securely in place during transport.



EPP4060F6R

Carrier with 6 Built-in Rails

EXTERIOR: L 77 x W 54 x H 68,7 cm

INTERIOR: L 61,5 x W 41 x H 58,5 cm

RAIL SPACING: 6 cm

UNIT WEIGHT: 6,34 kg

VOLUME: 126 L

Case Pack: 1 **Color:** Black (110).



EPP4060F9R

Carrier with 9 Built-in Rails

EXTERIOR: L 77 x W 54 x H 68,7 cm

INTERIOR: L 61,5 x W 41 x H 58,5 cm

RAIL SPACING: 3,5 cm

UNIT WEIGHT: 6,6 kg

VOLUME: 126 L

Case Pack: 1 **Color:** Black (110).

STOCK PRODUCTS & COLORS AVAILABLE IN OUR EUROPEAN WAREHOUSE

ALL CAM GOBOXES

TEMPERATURE RETENTION

4+ hours



Note: Best results will be achieved by loading pans between 82° to 88°C. Loading metal pans over 120°C will result in damage to the carrier.

CAM GOBOX® PROFESSIONAL GRADE INSULATED CARRIERS— FRONT LOADER – 60 X 40 CM

Front Loader without Rails

Multi-purpose carrier with no molded-in rails is designed for transporting 60 x 40 cm crates filled with wrapped, prepackaged foods. This carrier can also be modified for versatility to include optional, stainless steel adjustable rails, EPP4060FPR1*, for transporting a combination of 60 x 40 cm crates, baking pans and trays all in the same carrier.



EPP4060FNR

EXTERIOR: L 77 x W 54 x H 68,7 cm

INTERIOR: L 61,5 x W 41 x H 58,5 cm

UNIT WEIGHT: 6,1 kg

VOLUME: 155 L

Case Pack: 1 **Color:** Black (110).

*Additional rails can be purchased separately. See accessories page.

Front Loader with Adjustable Rails

The multi-purpose carrier with adjustable rails is designed with 2 sets of stainless steel adjustable rails.* This exclusive design provides the operator with maximum flexibility to transport a combination of 60 x 40 cm crates, baking pans and trays all in the same carrier.



EPP4060FADJR

EXTERIOR: L 77 x W 54 x H 68,7 cm

INTERIOR: L 61,5 x W 41 x H 58,5 cm

UNIT WEIGHT: 8,17 kg

VOLUME: 155 L

Case Pack: 1 **Color:** Black (110).

*Additional rails can be purchased separately. See accessories page.

**STOCK PRODUCTS &
COLORS AVAILABLE IN OUR
EUROPEAN WAREHOUSE**
ALL CAM GOBOXES



CAM GOBOX® 4060 PROFESSIONAL GRADE INSULATED CARRIERS— TOP LOADERS FOR 60 X 40 CM CRATES

Top loading 60 x 40 cm carriers are lightweight and designed to keep hot or cold food out of the danger zone for 4+ hours. Designed to transport bakery crates and more, 60 x 40 GoBoxes even have room for a cold plate Camchiller® or hot plate Camwarmer® to enhance temperature retention. Ergonomic, recessed handles for convenient carrying and transporting.



Cam GoBoxes inter-stack and also stack with major competitive brands.

Recessed handles ease carrying and storage.

A built-in label area keeps optional plastic menu tags in place for easy content identification or routing. StoreSafe® Labels can also be used with Cam GoBoxes.



EPP4060T200

20 cm Deep Top Loader

EXTERIOR: L 69 x W 49 x H 27 cm

INTERIOR: L 62,5 x W 42,5 x H 20,5 cm

UNIT WEIGHT: 1,4 kg

VOLUME: 53 L

Case Pack: 1 **Color:** Black (110).



EPP4060T300

30 cm Deep Top Loader

EXTERIOR: L 69 x W 49 x H 37 cm

INTERIOR: L 62,5 x W 42,5 x H 30,5 cm

UNIT WEIGHT: 1,7 kg

VOLUME: 80 L

Case Pack: 1 **Color:** Black (110).

TEMPERATURE RETENTION

4+ hours

**STOCK PRODUCTS & COLORS AVAILABLE
IN OUR EUROPEAN WAREHOUSE**

ALL CAM GOBOXES



CAM GOBOX® 4060 ACCESSORIES

Camchiller®

Camchiller (Cold plate) is designed to extend the cold holding time of your food. Simply freeze flat overnight and place at the top of your top-loading carrier or at the back of your front-loading carrier.

CP3253

Camchiller GN 1/1 fits all
Cam GoBoxes 4060

L 53 x W 32,5 x H 3 cm

UNIT WEIGHT: 3,9 kg

Case Pack: 1 Color: Glacier Blue (443).



Camwarmer®

Camwarmer (Hot plate) is designed to extend the hot holding time of your food. Place in a hot water bath for 40 minutes and place at the bottom of your top-loading carrier or at the back of your front-loading carrier.

HP3253

Camwarmer GN 1/1 fits all
Cam GoBoxes 4060

L 53 x W 32,5 x H 3 cm

UNIT WEIGHT: 3,25 kg

Case Pack: 1 Color: Fire Red (444).



Cam GoBox 60x40 Extender

Add 10 cm to your top loader GoBox to fit oversize items.

EPP4060EXT

10 cm Extender fits
EPP4060T200, EPP4060T300

L 68,7 x W 48,7 x H 10,1 cm

UNIT WEIGHT: 0,30 kg

Case Pack: 1 Color: Black (110).



Cam GoHeat™

Warms to 75°C in just 10 minutes after plugging in. Place in the bottom of your insulated carrier or use to hold or display hot foods on a table top, counter or buffet.

CGH100WUK 100W, 230V* UK
CGH200WUK 200W, 230V* UK
CGH100WEU 100W, 230V* EU
CGH200WEU 200W, 230V* EU
CGH1W12VCAR 100W, 12V - 14,2V Auto

L 49,5 x W 28,5 x H 1,2 cm

UNIT WEIGHT: 1,1 kg

Case Pack: 1 Color: Silver (486)
*220-240 volt alternating current.



Kit of Rails for EPP4060FPR1

Kit of 2 adjustable stainless steel rails can be purchased separately to transport more items within the same carrier.

EPP4060FAR

Kit of 2 adjustable stainless steel rails

L 60 x W 3 x H 3 cm

UNIT WEIGHT: 0,42 kg

Case Pack: 1 Color: Silver (000).



Adjustable Rail Kit for EPP4060FNR

Stainless Steel frames and 2 sets of rails are designed to offer the operator the flexibility to adjust and create custom spaces as needed in-between the rails.

EPP4060FPR1

Stainless Steel frames and 2 sets of rails

L 60 x W 1 x H 58 cm

UNIT WEIGHT: 2,07 kg

Case Pack: 1 Color: Silver (000).

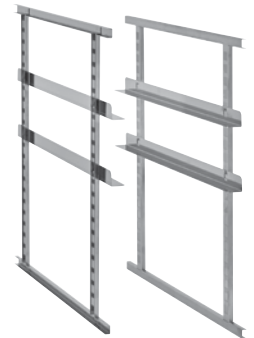

Camdolly® for Cam GoBoxes 4060

CD4060EPP

Camdolly fits Cam GoBoxes 4060
4 swivel casters, 2 with brake

EXTERIOR: L 71 x W 51 x H 16,7 cm

INTERIOR: L 70 x W 50 cm

UNIT WEIGHT: 5,27 kg

LOAD CAPACITY: 250 kg

Case Pack: 1 Color: Hot Red (158).



Plastic ID Labels

EPPID5

Plastic ID labels fits
all Cam GoBoxes

Case Pack: 1 Color: (000).



STOCK PRODUCTS & COLORS
AVAILABLE IN OUR EUROPEAN
WAREHOUSE

ALL CAM GOBOX ACCESSORIES

CAM GOBOX® PROFESSIONAL GRADE INSULATED CARRIERS— TOP-LOADING PIZZA CARRIER

Vent releases steam to keep crust crispy.

Holds 33 x 33 cm pizza boxes.



Available in four different heights that hold from two to eight pizzas.



EPPZ35100 without Strap

Cam GoBox Pizza Top Loading Carrier 10 cm Tall

EXTERIOR: L 41 x W 41 x H 17,4 cm

INTERIOR: L 35 x W 35 x H 10 cm

UNIT WEIGHT: 0,68 kg

CAPACITY*: 2 pizzas

Case Pack: 1 **Color:** Black (110).



EPPZ35175 without Strap

EPPZ35175BST with Black Strap

EPPZ35175RST with Red Strap

Cam GoBox Pizza Top Loading Carrier 17,5 cm Tall

EXTERIOR: L 41 x W 41 x H 24,9 cm

INTERIOR: L 35 x W 35 x H 17,5 cm

UNIT WEIGHT: 0,82 kg / 0,89 kg with Strap

CAPACITY*: 4 pizzas

Case Pack: 1 **Carrier Color:** Black (110).



EPPZ35265 without Strap

EPPZ35265BST with Black Strap

EPPZ35265RST with Red Strap

Cam GoBox Pizza Top Loading Carrier 26,5 cm Tall

EXTERIOR: L 41 x W 41 x H 33,9 cm

INTERIOR: L 35 x W 35 x H 26,5 cm

UNIT WEIGHT: 1 kg / 1,07 kg with Strap

CAPACITY*: 6 pizzas

Case Pack: 1 **Carrier Color:** Black (110).



EPPZ35330 without Strap

EPPZ35330BST with Black Strap

EPPZ35330RST with Red Strap

Cam GoBox Pizza Top Loading Carrier 33 cm Tall

EXTERIOR: L 41 x W 41 x H 40,4 cm

INTERIOR: L 35 x W 35 x H 33 cm

UNIT WEIGHT: 1,23 kg / 1,3 kg with Strap

CAPACITY*: 8 pizzas

Case Pack: 1 **Carrier Color:** Black (110).

TEMPERATURE RETENTION

4+ hours

*With 33 x 33 x 4 cm Pizza Box.

**STOCK PRODUCTS & COLORS AVAILABLE
IN OUR EUROPEAN WAREHOUSE**

ALL CAM GOBOXES



CAM GOBOX® PROFESSIONAL GRADE INSULATED CARRIERS— BEVERAGE CARRIER, CUP HOLDER AND EPP280 WITH STRAP



EPPBEVBKST



EPPBEVRDST

Designed to hold 12-750 mL tall items such as wine bottles or 12-1,5 liter plastic bottles.



EPP280RDST

Comes with convenient, plastic carrying strap.

Beverage Carrier



EPPBEVBKST with Black Strap
EPPBEVRDST with Red Strap

EXTERIOR: L 42 x W 33,5 x H 42 cm

INTERIOR: L 35,8 x W 27,3 x H 36,7 cm

UNIT WEIGHT: 1,02 kg

CAPACITY: 35 L

Case Pack: 1 Carrier Color: Black (110).

EPP280 with Strap



EPP280BKST with Black Strap
EPP280RDST with Red Strap

EXTERIOR: L 39 x W 33 x H 31,6 cm

INTERIOR: L 33 x W 27 x H 25,3 cm

UNIT WEIGHT: 0,8 kg

CAPACITY: 22,3 L

Case Pack: 1 Carrier Color: Black (110).

Beverage Cup Holder

Modular beverage holder for transporting hot or cold drinks with ease. Interlocking units connect to hold up to 15 drinks in an EPP180. Holds 350 to 750 mL hot or cold cups.

CODE	DESCRIPTION	DRINK CAPACITY
EPPBEVH1	single holder	3
EPPBEVH2	set of 2 holders	6
EPPBEVH5	set of 5 holders	15

Exterior Dim.: L 11,4 x W 32,5 x H 12,5 cm

Case Pack: 1 Color: Black (110).

GOBOX CODE	NUMBER OF DRINKS	NUMBER OF HOLDERS
EPP180	15 (single layer*) 30 (double layer**)	5 (single) 10 (double)
EPP160	15	5
EPP140	15	5
EPP280	6	2
EPP260	6	2

*Single layer only recommended for hot cups. Use with Beverage Plugs to prevent spilling during transport.

**Double layer possible only with 350 mL or smaller cups.

Compartments are tapered to fit multiple cup sizes: 7,1 cm at bottom graduates to 8,9 cm at the top.



TEMPERATURE RETENTION

4+ hours



**STOCK PRODUCTS & COLORS AVAILABLE
IN OUR EUROPEAN WAREHOUSE**

ALL CAM GOBOXES



CAM GOBOX® PROFESSIONAL GRADE INSULATED CARRIERS— MULTIPURPOSE TOP LOADER



Designed to hold disposable dishware or 5 liter Gelato pans.

EASY LOADING AND UNLOADING
Interior wall recesses make loading and unloading easy for both GN 1/1 as well as GN 1/2 Food Pans. Straight interior walls allow room for stacking pans inside carrier.

Cam GoBoxes inter-stack and also stack with major competitive brands.

A built-in label area keeps optional plastic menu tags in place for easy content identification or routing. StoreSafe® Labels can also be used with Cam GoBoxes.

Recessed handles ease carrying and storage.



EPP180X

For Disposable Sealed Dishes and Gelato Pans
20,5 cm deep

EXTERIOR: L 61 x W 43 x H 27 cm

INTERIOR: L 54,8 x W 36,8 x H 20 cm

UNIT WEIGHT: 1,18 kg

VOLUME: 41 L

Case Pack: 1 **Color:** Black (110).

EPP180XL

For Disposable Sealed Dishes and Gelato Pans
25 cm deep

EXTERIOR: L 61 x W 43 x H 32 cm

INTERIOR: L 54,8 x W 36,8 x H 25 cm

UNIT WEIGHT: 1,33 kg

VOLUME: 50,5 L

Case Pack: 1 **Color:** Black (110).

EPP180XLT

For Disposable Sealed Dishes and Gelato Pans
32 cm deep

EXTERIOR: L 61 x W 43 x H 39 cm

INTERIOR: L 54,8 x W 36,8 x H 32 cm

UNIT WEIGHT: 1,45 kg

VOLUME: 64,5 L

Case Pack: 1 **Color:** Black (110).

STOCK PRODUCTS & COLORS AVAILABLE IN OUR EUROPEAN WAREHOUSE

ALL CAM GOBOXES

TEMPERATURE RETENTION

4+ hours

Gelato holds
for 1 hour.

Disposable Dishes Holding Capacity



CAM GOBOXES	18 x 18 x 3 CM	19 x 20 x 6 CM	GN 1/1 FOOD PAN 10 CM DEEP
EPP180X	24	24	2
EPP180XL	30	42	3
EPP180XLT	42	48	4



CAM GOBOX® PROFESSIONAL GRADE INSULATED CARRIERS

Four-Compartment Meal Delivery Box

Designed to accommodate two complete meals (including hot item, cold item, bread or fruit, drink and cutlery), the 4-Compartment Cam GoBox is ideal for senior feeding, schools, hospitals and catering.



Two-Compartment Meal Delivery Box

This 2-compartment box is ideal for delivering a single meal. Each compartment has its own lid to protect temperatures, whether hot or cold.

Excellent insulation keeps hot foods hot and cold foods cold.

Includes built-in menu tag for content identification.



COLD FOOD COMPARTMENT

Holds plate 21 x 21 x 11 cm

HOT FOOD COMPARTMENT

Holds plate 19 x 19 x 11 cm

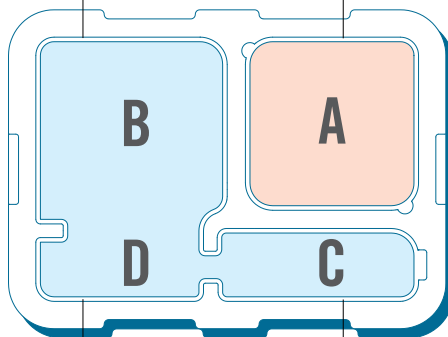

Holds fruit or bread:
18 x 8 x 11 cm

Holds bottle and cutlery:
21 x 8,5 x 11 cm

HOT OR COLD FOOD COMPARTMENTS

Holds plate 18,3 x 22,6 x 10,9 cm

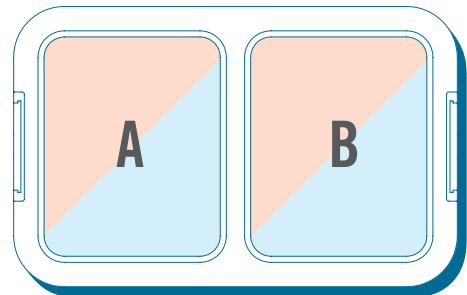

EPPMD4835

EXTERIOR: L 48 x W 35 x H 16,7 cm

INTERIOR: L 40 x W 29 x H 11 cm

UNIT WEIGHT: 400 g

Case Pack: 1 Color: Blue (159).

STOCK PRODUCTS & COLORS AVAILABLE IN OUR EUROPEAN WAREHOUSE

EPPMD4835: (159)

EPPMDB4428

EXTERIOR: L 43,7 x W 27,6 x H 17,5 cm

INTERIOR: L 18,3 x W 22,6 x H 10,9 cm Each Compartment

UNIT WEIGHT: 275 g

Case Pack: 1 Color: Blue (159).

Disposable Dishes Holding Capacity



CAM GOBOXES	18 x 18 x 3 CM	19 x 20 x 6 CM
EPPMD4835	4	2
EPPMDB4428	3	2

TEMPERATURE RETENTION

2+ hours



CAM GOBOX® PROFESSIONAL GRADE INSULATED CARRIERS— THE TABLOTERM CAM GOBOX MEAL DELIVERY SYSTEM



Excellent insulation and temperature retention.

Made of expanded polypropylene.

Maintains hot and cold foods safe in one unit for up to 60 minutes.

Stackable, lightweight individual meal delivery system for easy transportation and storage.

- | | | | | | | | | |
|--|--|---|---|---|---|---|---|---|
|  |  |  |  |  |  |  |  |  |
| 122 401 118 | 122 701 118 | 122 400 021 | 122 400 023 | 122 700 021
122 700 023 | 122 500 014 | 122 700 014 | MDSB16 (480) | CLRSB16T (490) |
| Rectangular porcelain plate
11 x 18 cm | Transparent rectangular plate cover

 | Round porcelain plate
ø 21 cm | Two-Compartment round porcelain plate
ø 23 cm | Transparent plate covers
ø 21,5 cm
ø 23,5 cm

 | Round porcelain bowl 500 mL | Rubber hermetic system bowl cover
ø 14,5 cm | Shoreline insulated bowl 500 mL | Polypropylene bowl cover
ø 14,5 cm |

TEMPERATURE RETENTION

1 hour



CAM GOBOX® PROFESSIONAL GRADE INSULATED CARRIERS— THE TABLOTHERM CAM GOBOX MEAL DELIVERY SYSTEM

Tablotherm Cam GoBox Only



ITENEPP

EXTERIOR: L 37 x W 53 x H 11,8 cm

Case Pack: 1 **Color:** Grey (107).



**STOCK PRODUCTS & COLORS
AVAILABLE IN OUR EUROPEAN
WAREHOUSE**

ALL TABLOTHERM CAM GOBOX

Tablotherm Cam GoBox with Accessories



ITENEPP1118

INCLUDED: 2 rectangular plates with covers, 2 round bowls with covers

EXTERIOR: L 37 x W 53 x H 11,8 cm

Case Pack: 1 **Color:** Grey (107).



ITENEPP21

INCLUDED: 1 round plate with cover, 2 round bowls with covers

EXTERIOR: L 37 x W 53 x H 11,8 cm

Case Pack: 1 **Color:** Grey (107).



ITENEPP23

INCLUDED: 1 two compartment plate with cover, 2 round bowls with covers

EXTERIOR: L 37 x W 53 x H 11,8 cm

Case Pack: 1 **Color:** Grey (107).



ITENEPP1118H

INCLUDED: 2 rectangular plates with covers, 2 round insulated bowls with covers

EXTERIOR: L 37 x W 53 x H 11,8 cm

Case Pack: 1 **Color:** Grey (107).



ITENEPP21H

INCLUDED: 1 round plate with cover, 2 round insulated bowls with covers

EXTERIOR: L 37 x W 53 x H 11,8 cm

Case Pack: 1 **Color:** Grey (107).



ITENEPP23H

INCLUDED: 1 two-compartment round plate with cover, 2 round insulated bowls with covers

EXTERIOR: L 37 x W 53 x H 11,8 cm

Case Pack: 1 **Color:** Grey (107).

















INSULATED TOP LOADING CAMCARRIERS® TO TRANSPORT GASTRONORM FOOD PANS

- Top-loading food pan carriers hold, transport and serve a single full-size pan of hot or cold food.
- Sturdy and durable, seamless polyethylene or polypropylene with thick foam insulation.
- Molded-in handles on all four sides for easy carrying and handling.
- Use with divider bars to hold multiple fractional pans.
- Pans are easy to remove using finger notches.
- Carriers interlock and stack for transporting and storing.

UPCS Colors: Dark Brown (131), Coffee Beige (157), Speckled Grey (480), Black (110).

MPC and MPCHL Colors: Navy Blue (186), Slate Blue (401), Coffee Beige (157), Dark Brown (131), Brick Red (402), Green (519), Black (110), Hot Red (158).

UPC Colors: Slate Blue (401), Dark Brown (131), Black (110), Granite Grey (191), Granite Green (192).

Camdolly® Colors: Coffee Beige (157), Dark Brown (131), Black (110), Slate Blue (401), Grey (180).

Divider Bar Colors: White (148), Clear (135).

See Food Pan Section for pricing and ordering information.

Note: Place food pans on rails. Pans should not be placed on the floor of a Camcarrier® cavity.

Note: Best results will be achieved by loading food pans between 82° to 88°C. Loading metal food pans over 121°C may result in damage to the carrier.



UPC140



No divider bars available for UPC100.

UPC160

Shown with dividers and fractional sized food pans.

Hot

UPC160	87°C	85°C	83°C	81°C	79°C
UPCS160	87°C	85°C	83°C	81°C	79°C
UPCSS160	87°C	85°C	83°C	81°C	79°C

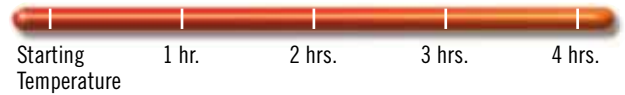

Cold

UPC160	0°C	1°C	2°C	2°C	2,5°C
UPCS160	0°C	1°C	2°C	2°C	2,5°C
UPCSS160	0°C	1°C	2°C	2°C	2,5°C



Camcarrier®

One-piece, seamless polyethylene construction, airtight removable gasket and sturdy plastic latches.



CODE	240MPC
COMPARTMENT CAPACITY	1 GN 1/2 – 10 cm deep pan
EXTERIOR DIMENSIONS W x D x H	42 x 35 x 19 cm
Case Pack:	1 240MPC No Divider Bar.

S-Series

Durable polypropylene construction, built in seal and wide, nylon latches.
Contemporary appearance and superior holding performance at an economical price.

STOCK PRODUCTS & COLORS AVAILABLE IN OUR EUROPEAN WAREHOUSE

UPCS180: (480)



CODE	UPCS140	UPCS160*	UPCS180
COMPARTMENT CAPACITY	1 GN 1/1 – 10 cm deep pan	1 GN 1/1 – 15 cm deep pan	1 GN 1/1 – 20 cm deep pan
EXTERIOR DIM. W x D x H	64 x 43,5 x 22 cm	64 x 43,5 x 26 cm	64 x 43,5 x 30,5 cm
FITS CAMDOLLY®	CD160	CD160	CD160

Case Pack: 1 *UPCS160 Cannot be used with Camchiller.

Ultra Pan

One-piece, seamless polyethylene construction, airtight removable gasket and wide, nylon latches.



CODE	UPC140	UPC160	UPC180
COMPARTMENT CAPACITY	1 GN 1/1 – 10 cm deep pan	1 GN 1/1 – 15 cm deep pan	1 GN 1/1 – 20 cm deep pan
EXTERIOR DIM. W x D x H	63 x 44 x 21 cm	63 x 44 x 26 cm	63 x 44 x 30,5 cm
FITS CAMDOLLY	CD100H, CD1826HB, CD160	CD100H, CD1826HB, CD160	CD100H, CD1826HB, CD160

Case Pack: 1

100 Series

Store and stack food pans or place food directly in compartment. The 100MPCHL model has a hinged serving lid.



CODE	100MPC	100MPCHL	UPC100
COMPARTMENT CAPACITY	3 GN 1/1 – 6,5 cm deep pan or 2 GN 1/1 – 10 cm deep pans or 1 GN 1/1 – 15 or 20 cm deep pan	1 GN 1/1 – 20 cm deep pan	3 GN 1/1 – 6,5 cm deep pans or 2 GN 1/1 – 10 cm deep pans or 1 GN 1/1 – 15 cm or 20 cm deep pan
EXTERIOR DIM. INTERIOR DIM. W x D x H	68 x 45 x 38 cm 55 x 35 x 20,5 cm	68 x 45 x 39,5 cm 55 x 35 x 20,5 cm	68 x 46 x 40 cm 56,5 x 33 x 20,5 cm
BULK CAPACITY*	38 L	38 L	38 L
FITS CAMDOLLY	CD100H, CD1826MTC, CD100HB, CD1826MTCHB, CD100, CD2028	CD100, CD100H, CD100HB	CD100H, CD1826MTC, CD100HB, CD1826MTCHB, CD100, CD2028

Case Pack: 1 *Without using food pans. 100MPC, 100MPCHL and UPC100 No Divider Bar.

Accessories

CODE	DIMENSIONS	CASE PACK
Divider Bars for Food Pans		
DIV12	32,38 cm length	3
DIV20	53,02	3

*Not for use in UPCSS1600.



CAMCHILLER®, THERMOBARRIER® AND CAMWARMER®



Camchiller

- An easy-to-use, cold food holding temperature tool.
- Extend cold holding time or enhance safe holding below 5°C when frequent access is required.
- Freeze first then use to pre-chill cabinet before loading.

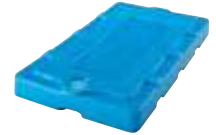
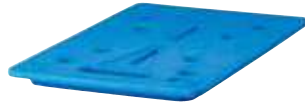
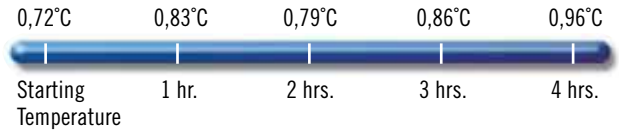

CODE	CP3253 (GN FULL SIZE)	CP2632 (GN HALF SIZE)	CP814 (20 x 36 CAMCHILLER)
FITS INTO	UPCSS160, UPC300, 300MPC, 1318CC, 1318MTC, UPC400, UPC400SP, UPSCS400, UPC600, UPC800, UPC800SP, UPC1200, UPC1600, CVC72, CVC724, all Combo Cart® Plus and CamKiosk®*	UPC300, 300MPC, 1318CC, 1318MTC, UPC400, UPSCS400, UPC400SP, UPC600, UPC800, UPC800SP, UPSCS140, UPSCS160, UPSCS180, CVC724*, CVC72* and all CamKiosks*	12186CW, 12186P, 12189CW, 12189P, CVC724, CVC72, CVC55, and all CamKiosks*
DIMENSIONS L x W x H	53 x 32,5 x 3 cm	32,5 x 26,5 x 3 cm	35,56 x 20,32 x 3,8 cm
COLOR	Glacier Blue (443)	Glacier Blue (443)	Cold Blue (159)
QUANTITY PER CAVITY	1 (*2 per cavity)	1 (*2 per top wells)	1

Case Pack: 1

ThermoBarrier

- Use to minimize empty space and food temperature loss within a partially loaded compartment.



STOCK PRODUCTS & COLORS AVAILABLE IN OUR EUROPEAN WAREHOUSE

400DIV: (180)

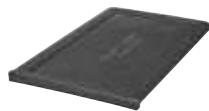

CODE	UPC300DIV	300DIV	400DIV	1200DIV	1600DIV
FITS INTO	UPC300, 1318CC	300MPC, 1318MTC, UPC600	UPC400, UPC800, UPC400SP, UPSCS400, UPC800SP	UPC1200, CVC72, CVC724	UPC1600, CamKiosk, UPC1600SP
DIMENSIONS L x W x H	53 x 33 x 2,5 cm	53 x 33 x 2,5 cm	54 x 33 x 3,8 cm	53 x 33,5 x 3,5 cm	53 x 33,5 x 3,8 cm
COLOR	Charcoal Gray (615)	Coffee Beige (157)	Grey (180)	Dark Brown (131)	Slate Blue (401)
CASE PACK	1	1	1	2	2

Camwarmer

- Use for added insurance to keep hot foods hot during holding and transporting.

- Keep in cabinet with hot foods to extend holding time or enhance safe holding above 65°C when frequent access is required.



CODE	1210PW	HP2632
FITS INTO	UPC300, 300MPC, 1318CC, 1318MTC, UPC400, UPSCS400, UPC600, UPC800	UPC300, 300MPC, 1318CC, 1318MTC, UPC400, UPSCS400, UPC400SP, UPC600, UPC800, UPC800SP, UPSCS140, UPSCS160, UPSCS180, CVC724, CVC72 and all CamKiosks
DIMENSIONS L x W x H	34 x 27,5 x 4 cm	32,5 x 26,5 x 3 cm
COLOR	Granite Grey (191)	Fire Red (444)

Case Pack: 1

UPC400 with Camwarmer.
Two Camwarmers recommended per cavity.

STOCK PRODUCTS & COLORS AVAILABLE IN OUR EUROPEAN WAREHOUSE

HP2632: (444)

TEMPERATURE MAINTENANCE – OPTIMIZE FOOD HOLDING PERFORMANCE

Camchiller® – GN 1/1 Size and GN 1/2 Size

- Use to:
 - Pre-chill cabinet cavity.
 - Hold package food in food pan wells. (Half Size Only)
 - Maximize cold food holding.
 - Minimize open cavity space.
- Easy to use:
 1. Freeze 8 hours.
 2. Slide one or two on top rails and pre-chill cavity 15-20 minutes.
 3. Load in pans of pre-chilled food below Camchiller. (A)
 4. Move pans and Camchiller down as food is removed. (B)

COLD HOLDING

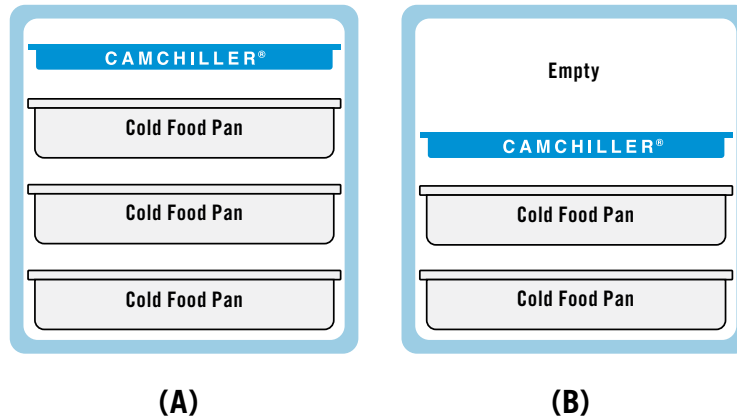

ThermoBarrier® – GN 1/1 Size

- Use to:
 - Hold hot and cold food in same cabinet cavity.
 - Minimize open cavity space.
- Easy to use:
 1. Slide between hot food on top and cold food on bottom. (A)
 2. Slide under hot food loaded in upper cavity space. (B)
 3. Slide above cold food loaded into lower cavity space. (C)

HOT AND COLD HOLDING

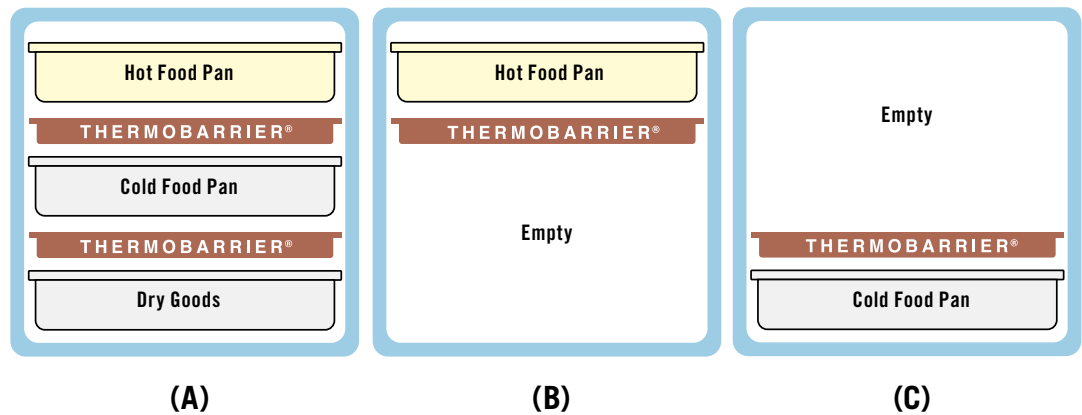

Camwarmer® – GN 1/2 Size

- Use to:
 - Pre-heat cabinet cavity.
 - Maximize hot food holding.
 - Minimize open cavity space.
- Easy to use:
 1. Heat in 180°C oven for 45 minutes.
 2. Slide two Camwarmers on bottom rails and pre-heat cavity 15-20 minutes. (or place on high heat food pan lid or sheet pan)
 3. Load in pans of pre-heated food above Camwarmers. (A)
 4. Move pans and Camwarmers up as food is removed. (B)

HOT HOLDING

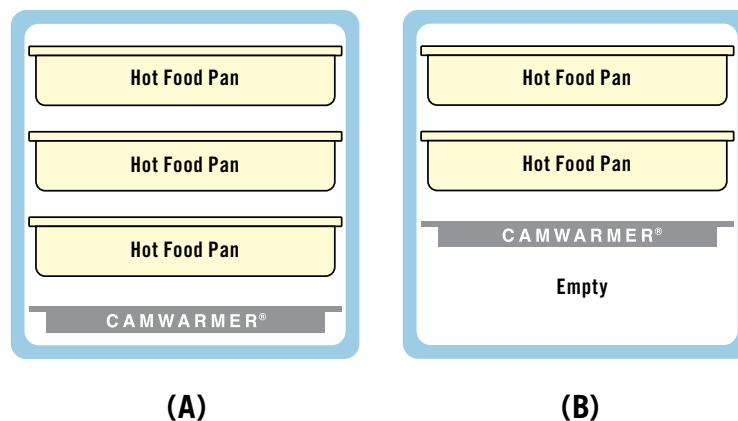

TRANSPORTER CAPACITY GUIDE

Loading Examples for Cambro® Insulated Transporters

TOP LOADERS

UPC140-UPC180
UPCS140-UPCS180
UPCSS160

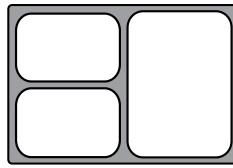
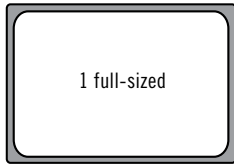

For a 3-course meal:
2 x GN 1/4
1 x GN 1/2
1 DIV12 divider bar
(approx. 14 meals)

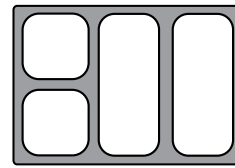

For a 4-course meal:
2 x GN 1/6
2 x GN 1/3
2 DIV12 divider bars
(approx. 14 meals)

TOP LOADERS

100 series
100MPC
UPC100

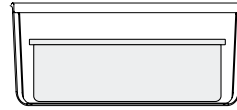
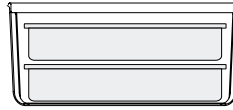
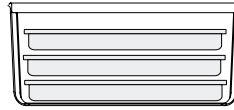

FRONT LOADERS

UPC300
1318CC
UPC600 (x2)
UPC1200 (x4)

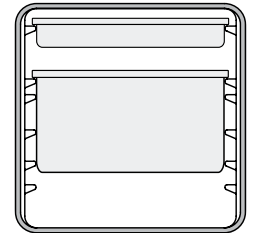
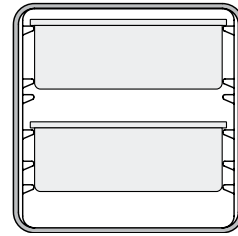
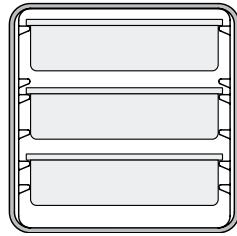
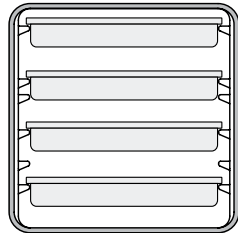

FRONT LOADERS

UPC400
UPCS400
UPCH400(2)
UPC800 (x2)
UPCH800(2) (x2)
UPC1600 (x4)
UPCH1600(2) (x4)

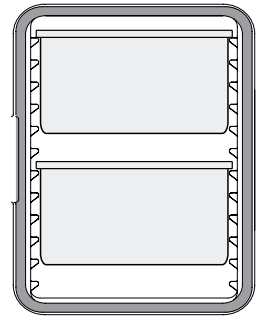
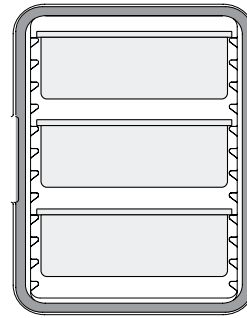
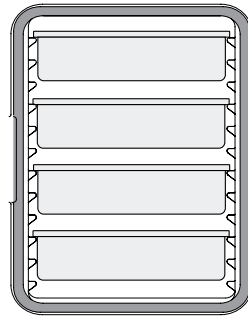
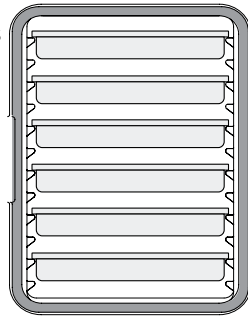

CAMCARRIERS® AND CAMCARTS® FOR SHEET PANS

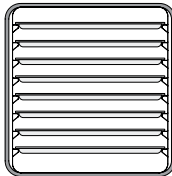

1318CC
1/2 size (x8)
sheet pans

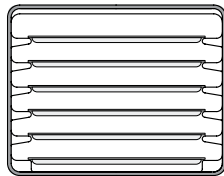

1826MTC
full-size (x6)
sheet pans
1826DTC (x4)

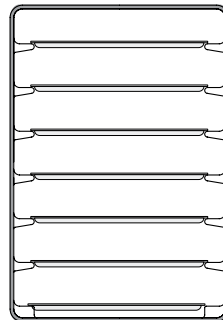

1826LTC3
full-size (x7)
sheet pans

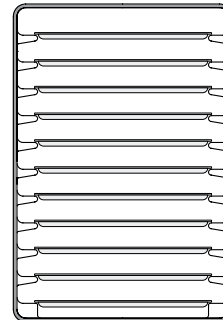

Camtherm Low
full-size (x11)
sheet pans
Camtherm Tall (x2)

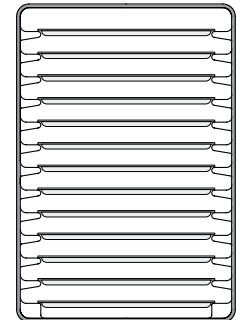

1826LTC
full-size (x13)
sheet pans

SUMMARY OF GN CONTAINER SIZES

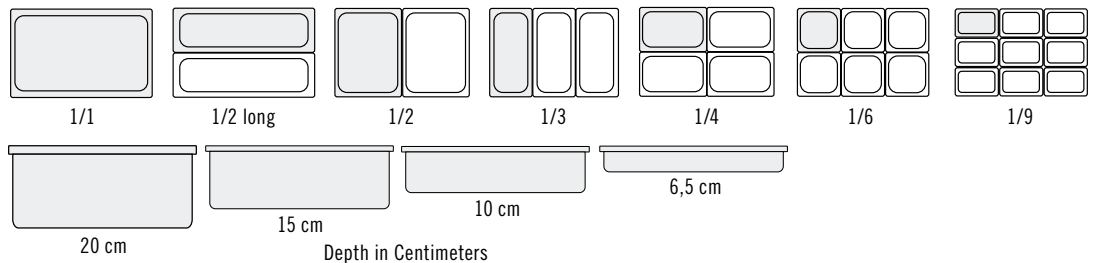

INSULATED FRONT LOADING UPC300 TO TRANSPORT GASTRONORM FOOD PANS



- Holds GN 1/1, GN 1/2 and GN 1/3 pans.
- One-piece seamless construction for great durability.
- Thick polyurethane insulation safely keeps cold food below 4°C, hot food above 64°C for 4+ hours.
- Fully removable, door.
- Labeling area on door for adhering ID or routing labels.
- Light weight.

Colors: Black (110), Dark Brown (131), Hot Red (158), Navy Blue (186), Slate Blue (401), Charcoal Gray (615).

UPC300 is covered by US Patent D786,607 S.



STOCK PRODUCTS & COLORS AVAILABLE IN OUR EUROPEAN WAREHOUSE

UPC300: (401), (110)
CP3253: (443), **HP3253:** (444)
CD300: (401)



Recommended labeling with: 23SLINB250 5 x 7,6 cm StoreSafe® Labels.

CODE	UPC300
EXTERIOR DIM. W x D x H	43,2 x 65,4 x 56,8 cm
INTERIOR DIM. W* x D x H	33,7 x 53,3 x 35,5 cm
UNIT WEIGHT	10,5 kg

Case Pack: 1 *Rail to Rail.

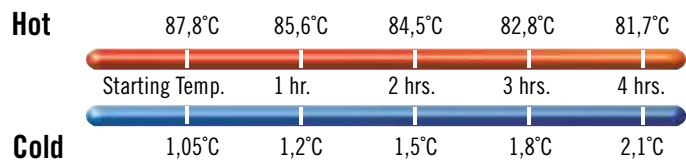

Optional Accessories

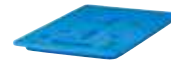

CODE	1210PW	HP3253	UPC300DIV	CP3253	CD300*
DESCRIPTION	Camwarmer®	Camwarmer	ThermoBarrier®	Camchiller®	Camdolly®
EXTERIOR DIM. (CM)	34,9 x 27,6 x 4	53 x 32,5 x 3	53 x 33 x 2,5	53 x 32,5 x 3	49 x 65 x 26,5
INTERIOR DIM. (CM)	—	—	—	—	43 x 59
COLOR	Granite Grey (191)	Fire Red (444)	Charcoal Gray (615)	Glacier Blue (443)	▲

Case Pack: 1 *Also available CD300H and CD300HB. See Camdolly section. ▲Camdolly Colors: Slate Blue (401), Coffee Beige (157), Dark Brown (131), Black (110).



INSULATED FRONT LOADING UPC400 TO TRANSPORT GASTRONORM FOOD PANS

- Durable and dependable front-loading food pan carriers.
- Hold multiple pans of hot or cold food at safe temperatures for hours.
- Seamless polyethylene with thick foam insulation.
- Airtight removable gasket provides a secure seal.

Colors: Navy Blue (186), Slate Blue (401), Coffee Beige (157), Dark Brown (131), Black (110), Granite Grey (191), Granite Green (192), Granite Sand (194).

Note: Place food pans on rails. Pans should not be placed on the floor of a Camcarrier® cavity. Please use specified food pan sizes.

See Food Pan section for pricing and ordering information.

Note: Best results will be achieved by loading food pans between 82° to 88°C. Loading metal food pans over 121°C may result in damage to the carrier or cart.

UPC400 is covered by US Patent D 392,158.

Venting plug is covered by US Patent D 553,717 S.



HOLDING CAPACITY:

Pan Depth	Number of GN 1/1 pans
6,5 cm	6
10	4
15	3
20	2

Also holds GN 1/2 and 1/3 size pans.

STOCK PRODUCTS & COLORS AVAILABLE IN OUR EUROPEAN WAREHOUSE

UPC400, CD400: (401), (110)
400DIV: (180)
CP3253: (443)
HP3253: (444)

ERGONOMIC DESIGN

Unbreakable, ergonomic, molded-in handles for comfortable two-person carrying.



PRESSURE AND HUMIDITY CONTROL
Pop-up vent.



TEMPERATURE RETENTION

Polyurethane insulation keeps hot food hot and cold food cold.



QUICK ACCESS

Single, 23 cm nylon latch for quick and secure opening and closing.

REMOVABLE GASKET

Provides an airtight seal.

Hot

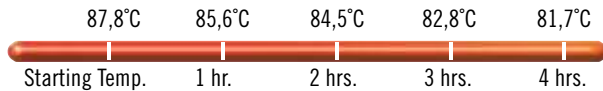

Cold

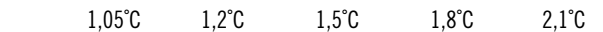

CODE

CODE	UPC400 (UPC400SP**)
EXTERIOR DIM. W x D x H	42,5 x 62 x 62 cm
INTERIOR DIM. W* x D x H	34 x 53,5 x 49 cm
UNIT WEIGHT	14,3 kg (16,33 kg)

Case Pack: 1 *Rail to Rail. **Security Package (SP) Model.

Optional Accessories

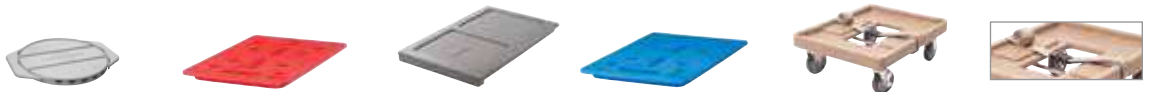

CODE	1210PW	HP3253	400DIV	CP3253	CD400	400STP
DESCRIPTION	Camwarmer®	Camwarmer	ThermoBarrier®	Camchiller®	Camdolly®	Strap
EXTERIOR DIM. (CM)	34,9 x 27,6 x 4	53 x 32,5 x 3	54 x 33 x 3,8	53 x 32,5 x 3	71 x 53 x 23	381 cm long
INTERIOR DIM. (CM)	—	—	—	—	63,5 x 46	—
COLOR	Granite Grey (191)	Fire Red (444)	Grey (180)	Glacier Blue (443)	▲	Beige (000)

Case Pack: 1 ▲CD400 Colors: Coffee Beige (157), Dark Brown (131), Black (110), Slate Blue (401).

UPCS400 ULTRA PAN CARRIER® S-SERIES TO TRANSPORT GASTRONORM FOOD PANS

- Ultra dependable, ultra durable front-loading pan carrier.
- Holds multiple pans of hot or cold food for hours.
- Durable polyethylene shell and thick, polyurethane foam insulation.

Colors: Slate Blue (401), Speckled Grey (480), Dark Brown (131).

Note: Best results will be achieved by loading food pans between 82° to 88°C. Loading metal food pans over 121°C may result in damage to the carrier or cart.



HOLDING CAPACITY:

Pan Depth	Number of GN 1/1 pans
6,5 cm	6
10	4
15	3
20	2

Also holds GN 1/2 and 1/3 size pans.



Stacks with both UPCS400. Fits on CD400 Camdolly, or optional casters may be added for smooth ground transport.

STOCK PRODUCTS & COLORS AVAILABLE IN OUR EUROPEAN WAREHOUSE

UPCS400: (480), (401), **CD400:** (401), (110)
400DIV: (180), **CP3253:** (443), **HP3253:** (444)

EASY CONTENT AND ROUTING LABELING

Menu clip reduces need to open door.



CONVENIENT

Integrated pan-staging area eases service (not for use during transport).

EASY TO CLEAN

Door removes for easy cleaning.



TEMPERATURE RETENTION

Polyurethane insulation keeps hot food hot and cold food cold.



ERGONOMIC DESIGN

Unbreakable, ergonomic, molded-in handles for comfortable two-person carrying.

QUICK ACCESS

Single, 23 cm nylon latch for quick and secure opening and closing.



BUILT-IN SEAL

Built-in seal eliminates need for removable gasket.

PRESSURE CONTROL

Built-in vent equalizes pressure and releases steam.

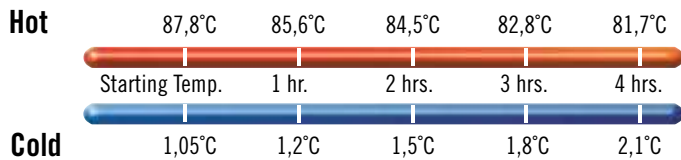

CODE

EXTERIOR DIM. W x D x H

INTERIOR DIM. W x D x H

UNIT WEIGHT

Case Pack: 1

UPCS400

63,5 x 46 x 63 cm

53,5 x 33,5 x 48,6 cm

21,1 kg

Optional Accessories

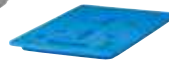

CODE	UPCS400CK	1210PW	HP3253	400DIV	CP3253	CD400	400STP
DESCRIPTION	Caster Kit*	Camwarmer®	Camwarmer	ThermoBarrier®	Camchiller®	Camdolly®	Strap
EXTERIOR DIM. (CM)	ø 12,7	34,9 x 27,6 x 4	53 x 32,5 x 3	54 x 33 x 3,8	53 x 32,5 x 3	71 x 53 x 23	381 cm long
INTERIOR DIM. (CM)	—	—	—	—	—	63,5 x 46	—
COLOR	—	Granite Grey (191)	Fire Red (444)	Grey (180)	Glacier Blue (443)	▲	Beige (000)

Case Pack: 1 *Optional Caster Kit for UPCS400: 2 fixed, 2 swivel, 1 w/ brake. ▲CD400 Colors: Coffee Beige (157), Dark Brown (131), Black (110), Slate Blue (401).



ULTRA CAMCARTS® TO TRANSPORT GASTRONORM FOOD PANS

- Double-compartment, high-capacity carts hold and transport hot or cold food.
- Tough, polyethylene shell and thick foam insulation throughout cabinet and between compartments.
- Airtight removable gaskets maintain safe food temperatures for hours.
- Easy to maintain and won't dent, crack, rust, chip or break.
- Durable nylon door latches open easily and close securely.
- Full-swing doors open to the side of the cart for easy loading and unloading.
- Molded-in handles ensure easy maneuvering.
- Molded-in bumpers minimize damage to walls, furniture and other equipment.

Colors: Navy Blue (186), Slate Blue (401), Coffee Beige (157), Dark Brown (131), Brick Red (402), Green (519), Black (110), Hot Red (158), Granite Grey (191), Granite Green (192), Granite Sand (194).

Note: Place food pans on rails. Pans should not be placed on the floor of a Camcart cavity. Please use specified food pan sizes.

Note: Best results will be achieved by loading food pans between 82° to 88°C. Loading metal food pans over 121°C may result in damage to the carrier or cart.

Venting plug is covered by US Patent D 553,717 S.



Polyurethane insulation keeps hot food hot and cold food cold.



Shown with optional HD casters.

Security Package (SP)

Specially designed for operations where safety and security are a top priority.

- Tamper resistant fasteners.
- Non-removable doors.
- Lockable hasp on each door (padlocks not included).
- Heavy duty (HD) casters with chassis plates mounted with tamper resistant bolts.

Marine rail is designed for use during service, not transport.



TOTAL CART HOLDING CAPACITY	UPC600	UPC800	UPC1200	UPC1600
Full Size Food Pans				
6,5 cm deep	8 pans	12 pans	16 pans	24 pans
10 cm deep	6 pans	8 pans	12 pans	16 pans
15 cm deep	4 pans	6 pans	8 pans	12 pans
20 cm deep	2 pans + 2 each 10 cm pans	4 pans	4 pans	8 pans
Camtray®**				
3253	12 trays	24 trays	24 trays	48 trays
2632	24 trays	48 trays	—	—
2025	—	—	12 trays	24 trays

See Food Pan and Camtray Section for ordering information.
*Based on 3,8 cm spacing between trays.

Hot

UPC600	86,8°C	84,3°C	82,5°C	80,8°C	79,3°C
UPC800	87,7°C	85,5°C	84,2°C	82,9°C	81,7°C
UPC1200	85,6°C	82,1°C	80,1°C	78,3°C	77,2°C
UPC1600	87,1°C	85,9°C	85,1°C	84,3°C	83,7°C

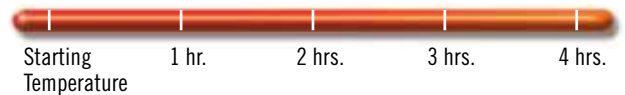

Cold

UPC600	0,6°C	1,1°C	1,4°C	1,8°C	2,1°C
UPC800	0,3°C	0,8°C	0,9°C	1,2°C	1,4°C
UPC1200	0,5°C	0,9°C	1,1°C	1,3°C	1,4°C
UPC1600	0,6°C	1,0°C	1,2°C	1,5°C	1,5°C





UPC600

CODE	UPC600
DESCRIPTION	Base model
EXTERIOR DIM. W x D x H	52 x 69 x 114,5 cm
COMPARTMENT DIM.	34 x 54 x 35,5 cm
Case Pack: 1	Casters: 12,7 cm, 2 fixed, 2 swivel, 1 with brake.



UPC800

CODE	UPC800	UPC800SP
DESCRIPTION	Base model	Security package
EXTERIOR DIM. W x D x H	52 x 69 x 137 cm	52 x 69 x 137 cm
COMPARTMENT DIM.	33 x 54,5 x 48,5 cm	33 x 54,5 x 48,5 cm
Case Pack: 1	Casters: 15,2 cm, 2 fixed, 2 swivel, 1 with brake.	
Heavy Duty (HD) Casters:	15,2 x 3,8 cm, 2 fixed, 2 swivel with brake casters.	



UPC1200

CODE	UPC1200
DESCRIPTION	Base model
EXTERIOR DIM. W x D x H	72,5 x 82 x 116 cm
COMPARTMENT DIM.	54 x 66,5 x 34,5 cm
Case Pack: 1	Casters: 15,2 cm, 2 fixed, 2 swivel, 1 with brake.



UPC1600

CODE	UPC1600	UPC1600HD	UPC1600SP*	UPCGL1600SP*
DESCRIPTION	Base model	Base model with HD casters	Security package	Security package, gasketless
EXTERIOR DIM. W x D x H	71,5 x 82 x 135 cm	73 x 84,7 x 138,4 cm	71,5 x 82 x 135 cm	71,5 x 82 x 135 cm
COMPARTMENT DIM.	53,5 x 66,5 x 53,5 cm	53,5 x 66,5 x 53,5 cm	53,5 x 66,5 x 53,5 cm	53,5 x 66,5 x 53,5 cm
Case Pack: 1	Casters: 15,2 cm, 2 fixed, 2 swivel, 1 with brake. Heavy Duty (HD) Casters: 15,2 x 5,08 cm 2 fixed, 2 swivel with brake casters.			
	*Security Package (SP) have lock-in hinge pins and latches and wheels are attached with tamper resistant screws.			



STOCK PRODUCTS & COLORS AVAILABLE IN OUR EUROPEAN WAREHOUSE

UPC600: (401), (110), UPC800: (401), (192), (194), (110), UPC1200: (401)
UPC1600: (401), (194), (110), 400DIV: (180), CP3253: (443), HP3253: (444)

Optional Accessories



CODE	300DIV	400DIV	1200DIV	1600DIV	CP3253	HP3253	1210PW
DESCRIPTION	ThermoBarrier®	ThermoBarrier	ThermoBarrier	ThermoBarrier	Camchiller®	Camwarmer®	Camwarmer
DIMENSIONS (CM)	53 x 33 x 2,5	54 x 33 x 2,5	53 x 33,5 x 3,5	53 x 33,5 x 3,8	53 x 32,5 x 3	53 x 32,5 x 3	34 x 27,5 x 4
FITS	UPC600	UPC800, UPC800SP	UPC1200	UPC1600	UPC600, UPC800, UPC800SP, UPC1200, UPC1600, UPC1600SP	UPC600, UPC800, UPC800SP	UPC600, UPC800, UPC800SP
COLOR	Coffee Beige (157)	Grey (180)	Dark Brown (131)	Slate Blue (401)	Glacier Blue (443)	Fire Red (444)	Granite Grey (191)

Case Pack: 1 1200DIV / 1600DIV Case Pack: 2

INSULATED FOOD SERVERS
CAMCARTS®
Reimagined



For Trays and
Sheet Pans



1826DTC
L 54,6 x W 84,5 x H 162 cm

For
Food Boxes



1826DBC
L 54,6 x W 84,5 x H 162 cm

IMPROVED ERGONOMICS
with two molded-in vertical
handles for easy maneuvering

ROBUST
Stainless
Steel Hinges



CAMCARRIERS® & CAMCARTS®



Camcarriers

- Holds 32,5 x 53 cm trays, sheet pans and GN food pans.
- One piece seamless construction with molded-in handles.

Colors: Black (110), Slate Blue (401), Coffee Beige (157), Dark Brown (131), Navy Blue (186), Charcoal Gray (615).
1318CC also available in Hot Red (158).

Note: Cool metal sheet pans to 121°C before placing onto tray supports.

Venting plug is covered by U.S. Patent D 553,717S.



Combo Carrier

1318CC

Holds half-size sheet pans, trays and a variety of food pan sizes. Safely keeps cold food below 4°C, hot food above 63°C for 4+ hours. Interstacks with UPC300, 300MPC, 1318MTC

EXTERNAL DIM. W x D x H*:
43,2 x 65,4 x 56,8 cm

INTERIOR DIM. W x D x H:
33,7 x 53,3 x 35,5 cm

FITS CAMDOLLY:
CD300, CD300H, CD300HB

Case Pack: 1 *With Handle.



Camcarrier

1826MTC

Holds up to 6 each 46 x 66 cm sheet pans. Six tray supports on 5,4 cm centers

EXTERNAL DIM. W x D x H*:
55 x 74,5 x 57 cm

INTERIOR DIM. W x D x H:
46,7 x 66,4 x 35,9 cm

FITS CAMDOLLY:
CD1826MTC, CD1826MTCHB

Case Pack: 1 *With Handle.



1826HAR

Lifting harness

DIMENSION: 360,68 cm long

Color: Beige (000).

Camcarts

- Holds 46 x 66 cm trays, sheet pans and food boxes.
- Includes removable cutting board on top.
- Security Package (SP)* features tamper-resistant hardware to protect both cart and contents. Includes chassis plates with 15,2 x 3,8 cm HD Casters.

Colors: Slate Blue (401), Coffee Beige (157), Dark Brown (131), Navy Blue (186), Charcoal Gray (615).

Standard Casters: 15,2 x 3,2 cm, 2 fixed, 2 swivel, 1 with brake.

Heavy Duty (HD) Casters: 15,2 x 5 cm, 2 fixed, 2 swivel, no brake.

Note: Cool metal sheet pans to 121°C before placing onto tray supports.

Venting plug is covered by U.S. Patent D 553,717S.



Camcart for Food Storage Boxes

1826LBC / 1826LBCSP*

Holds 46 x 66 cm Food Storage Boxes. Capacity: 13 supports on 4,45 cm centers

EXTERNAL DIM. W x D x H:
55 x 81,5 x 95,5 cm

INTERIOR DIM. W x D x H:
46 x 66,4 x 65,7 cm

Case Pack: 1



Camcart for Trays and Sheet Pans

1826LTC / 1826LTCSP*

Holds up to 13 each 46 x 66 cm trays or sheet pans. Thirteen tray supports on 4,45 cm centers

EXTERNAL DIM. W x D x H:
55 x 81,5 x 95,5 cm

INTERIOR DIM. W x D x H:
46 x 66,4 x 65,7 cm

Case Pack: 1



Camcart for Trays and Sheet Pans

1826LTC3

Holds up to 7 each 46 x 66 cm trays or sheet pans. Seven tray supports on 9,5 cm centers for 7,62 cm clearance between trays

EXTERNAL DIM. W x D x H:
55 x 81,5 x 95,5 cm

INTERIOR DIM. W x D x H:
46 x 66,4 x 65,7 cm

Case Pack: 1



ULTRA PAN CARRIER® AND ULTRA CAMCART® H-SERIES

- Designed for both electric hot holding and non-electric transport.
- Gentle, 65° to 74°C non-radiant heat will not cook food and maintains food moisture.
- Holds a wide variety of foods such as pasta, bone-in fried chicken, and double-crust pies.
- One hour preheat time from room temperature and three minute recovery.
- Energy consumption is substantially less than comparable metal cabinets.
- Will not rust or dent like metal cabinets, is more economical, and is easy to maneuver.
- All UPCH models have been tested to maintain safe, hot food temperatures, for up to 4 hours when unplugged.
- Models with only the top heated door offer unique versatility with an electric hot holding cabinet on top and passive hot or cold food holding on the bottom.
- Heated door kits also sold separately to retrofit UPC400, UPC800 and UPC1600.

Colors: Granite Gray (191), Black (110), Granite Green (192), Slate Blue (401), Dark Brown (131).

Casters: 15,2 cm 2 fixed, 2 swivel, 1 with brake.



Power On and Heat On Indicators

Communicate the Power and Heating status of the UPCH1600 unit. Know instantly when the compartment has reached target temperature.



Vents

Consistent heating throughout the compartment is generated by vents that constantly circulate heat from front to back.



Tough Exterior

All UPCH units are made of tough, polyethylene with polyurethane foam insulation to keep heat in while keeping the exterior cool to the touch. Will not crack, dent, chip, rust or break.



Insulation

Foamed-in place polyurethane foam insulation will hold temperature above 64°C for up to 4 hours when used unplugged.

ULTRA PAN CARRIER® AND ULTRA CAMCART® H-SERIES

Marine rail is designed for use during service, not transport.



MODEL	UPCH4002	UPCH8002	UPCH16002
Electrical Specifications			
REQUIRED VOLTAGE	200 – 230 VAC	200 – 230 VAC	200 – 230 VAC
MAXIMUM AMP.	1,2a	1,2a	2,3a
WATTS	265w	265w	506w
HERTZ	50/60	50/60	50/60
PLUG TYPE	Euro plug, CEE7	Euro plug, CEE7	CEE7/7 to C15RA
POWER CORD LENGTH	2,7 m	2,7 m	2,7 m

Hot Holding When Unplugged

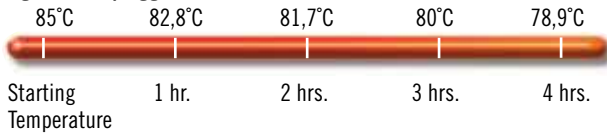

HOT HOLDING

65° – 74°C

WARM UP TIME

(from ambient to temperature)

1 hour

RECOVERY TIME*

(time to recover to temperature after door is held open for 30 seconds)

3 minutes

TRANSPORT TIME*

(after reaching temperature, amount of time unit can be held passively/unplugged until contents reach 65°C.)

4 hours+

*Based on test with 6 each, 15,24 cm deep H-pans with GripLids® filled with approx 14,2 L of 87,7°C water. (Temperatures are of the water not the air in the cart).

Capacity Guide

UPCH4002
UPCH8002 (x2)
UPCH16002 (x4)

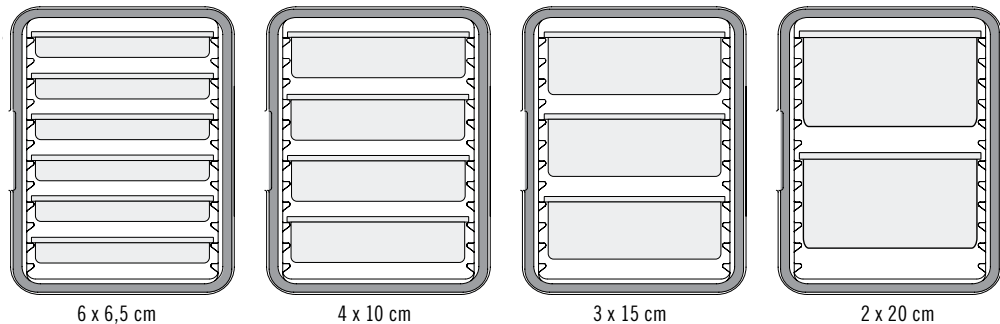

Food Pan Portion Guide

GN 1/1 Food Pan

DEPTH	20 cm	15 cm	10 cm	6,5 cm
SERVING PORTIONS PER PAN (1 CUP)	80	60	40	30

ULTRA PAN CARRIER® AND ULTRA CAMCARTS® H-SERIES

- Enables HACCP compliance by maintaining safe, hot food temperatures.
- UPCH400(2) models stack for storage or transporting on a Camdolly® with securing strap.

Colors: Granite Grey (191), Granite Green (192), Slate Blue (401), Black (110), Dark Brown (131).

CD400 Colors: Coffee Beige (157), Dark Brown (131), Black (110), Slate Blue (401), Grey (180).

Casters: 15,2 cm 2 fixed, 2 swivel, 1 with brake.

Note: If using metal food pans, cool to 120°C before placing onto rails.

Note: Place food pans on rails. Pans should not be placed on the floor of a Camcart cavity. Please use specified food pan sizes.

Vent Cap Patent Pending.



Security Package (SP)

Specially designed for operations where safety and security are a top priority.

- Tamper-resistant fasteners.
- Non-removable doors.
- Lockable hasp on each door (padlocks not included).
- Heavy duty (HD) casters with chassis plates mounted with tamper-resistant bolts.

CODE	DESCRIPTION	EXTERIOR DIMENSIONS W x D x H	COMPARTMENT DIMENSIONS W x D x H
UPCH1600SP	110V, Both doors heated	73 x 84,7 x 138,4 cm	53,5 x 66,5 x 53,5 cm
UPCH16002SP	220V, Both doors heated	73 x 84,7 x 138,4	53,5 x 66,5 x 53,5

STOCK PRODUCTS & COLORS AVAILABLE IN OUR EUROPEAN WAREHOUSE

UPCH4002, UPCH4002UK, UPCH8002, UPCH8002UK, UPCHT8002, UPCH16002, UPCH16002UK, CD400: (401), (110)

CODE	DESCRIPTION	EXTERIOR DIMENSIONS W x D x H	COMPARTMENT DIMENSIONS W x D x H
1-Compartment Ultra Pan Carriers			
110V			
UPCH400	No casters	46 x 67 x 63 cm	33,5 x 53,3 x 48,6 cm
UPCHW400	With casters	46 x 67 x 79,4	33,5 x 53,3 x 48,6
220V			
UPCH4002	No casters	46 x 67 x 63	33,5 x 53,3 x 48,6
UPCH4002UK	UK plug, no casters	46 x 67 x 63	33,5 x 53,3 x 48,6
UPCHW4002	With casters	46 x 67 x 79,4	33,5 x 53,3 x 48,6
2-Compartment Ultra Camcarts			
110V			
UPCH800	Both doors heated	52 x 69 x 137,2	33 x 54,5 x 48,5
UPCHT800	Top door heated only	52 x 69 x 137,2	33 x 54,5 x 48,5
UPCH1600	Both doors heated	73 x 84,7 x 137,5	53,5 x 66,5 x 53,5
UPCH1600HD	Both doors heated, HD casters	73 x 84,7 x 138,4	53,5 x 66,5 x 53,5
UPCHT1600	Top door heated only	73 x 84,7 x 137,5	53,5 x 66,5 x 53,5
UPCHT1600HD	Top door heated only, HD casters	73 x 84,7 x 138,4	53,5 x 66,5 x 53,5
220V			
UPCH8002	Both doors heated	52 x 69 x 137,2	33 x 54,5 x 48,5
UPCH8002UK	UK plug, both doors heated	52 x 69 x 137,2	33 x 54,5 x 48,5
UPCHT8002	Top door heated only	52 x 69 x 137,2	33 x 54,5 x 48,5
UPCH16002	Both doors heated	73 x 84,7 x 137,5	53,5 x 66,5 x 53,5
UPCH16002UK	UK plug, both doors heated	73 x 84,7 x 137,5	53,5 x 66,5 x 53,5
UPCH16002HD	Both doors heated, HD casters	73 x 84,7 x 138,4	53,5 x 66,5 x 53,5
UPCHT16002	Top door heated only	73 x 84,7 x 137,5	53,5 x 66,5 x 53,5
UPCHT16002HD	Top door heated only, HD casters	73 x 84,7 x 138,4	53,5 x 66,5 x 53,5
Accessories			
CD400	Camdolly®	53 x 70 x 23	—
400STP	Strap, 4 m long	—	—

UPCH Case Pack: 1 **Also Available:** Top and Bottom Replacement/Retrofit Doors for 110V and 220V (non-interchangeable).

Standard Casters: 15,2 x 3,2 cm – 2 fixed, 2 swivel, 1 with brake. **Heavy Duty (HD) Casters:** 15,2 x 5 cm – 2 fixed, 2 swivel with brake.

Plug In to the Future of HOT and COLD

THE PRO-CART ULTRA[®] PAN CARRIERS

Power ON,
set the Temp
and **Go!**

Energy EFFICIENT

Hot & Cold Food
IN A SINGLE CART

Interchangeable MODULES



THE PRO CART ULTRA® – PAN CARRIERS



PCUL1000
10, 10 cm deep
GN Food Pans

PCU800
8, 10 cm deep
GN Food Pans

PCU1000
10, 10 cm deep
GN Food Pans

PCU1600
16, 10 cm deep
GN Food Pans

PCU2000
20, 10 cm deep
GN Food Pans



ELECTRIC HOT

Adjustable temperature
from 21,1° to 85°C,
heat up to 73,9°C in 15 min.

Recovery Time:
Average 20 sec.



ELECTRIC COLD

Adjustable temperature
from 0,3° to 21,1°C
without a compressor.

Recovery Time:
PCU1000 / Average 23 sec.
PCU2000 / Average 30 sec.

(Recovery time based on ambient temp.
of 23,33°C) Empty Compartments



Electrical Cord Storage

PCU1000 / PCU2000
ONLY



Holding Capacity

FOOD PAN DEPTHS

GN FOOD PANS	6,5 cm				10 cm					15 cm			20 cm							
GN 1/1	12	14	24	28	14	8	10	16	20	10	6	6	8	12	6	4	4	4	8	4
GN 1/2	24		28			16		20			12		12		8		8			
GN 1/3	36		36			24		24			18		18		12		12			

PCU800
PCU1000
PCU1600
PCU2000
PCUL1000

CODE	DESCRIPTION	DIMENSIONS W x D x H	PRODUCT WEIGHT
PCU800			
PCU800HH	2 active hot compartments	55,63 x 86,36 x 150,1 cm	46,24 kg
PCU800HC	1 active hot compartment (top), 1 active cold compartment (bottom)		50,21
PCU800CC	2 active cold compartments		54,18
PCU1000			
PCU1000HH	2 active hot compartments	55,88 x 86,36 x 170,18 cm	65,1
PCU1000HC	1 active hot compartment (top), 1 active cold compartment (bottom)		69,06
PCU1000CC	2 active cold compartments		73,03
PCU1600			
PCU1600HH	2 active hot compartments	76,2 x 96,52 x 149,86 cm	73,6
PCU1600HC	1 active hot compartment (top), 1 active cold compartment (bottom)		77,57
PCU1600CC	2 active cold compartments		81,31
PCU2000			
PCU2000HH	2 active hot compartments	76,20 x 96,52 x 172,72 cm	86,16
PCU2000HC	1 active hot compartment (top), 1 active cold compartment (bottom)		90,12
PCU2000CC	2 active cold compartments		94,1
PCUL1000			
PCUL1000H New!	1 active hot compartment	(76,2 x 96,52 x 100,33 cm)	53,30
PCUL1000C New!	1 active cold compartment		57,27
PCUL1000P New!	1 passive compartment		50,58
Modules*			
PCMCX	Cold Module	—	9,42
PCMHX	Hot Module	—	5,44

Case Pack: 1 Color: Charcoal Gray (615). Other configurations and Security Package available.

Tow Hitch Package Available for PCU2000 Only. *220V Models – Add your country code to any part number:

3	CAN	7	SA
4	EU	8	JAPAN
5	UK	9	CHINA
6	AU		

Pro Cart Ultra[®] STAINLESS STEEL GN Pan Carrier

- Total Capacity: 8, 10 cm deep GN 1/1 Food Pans
- Interchangeable Modules with Thermoelectric Cooling
- Corrosion-Free 304 Stainless Steel Cabinet

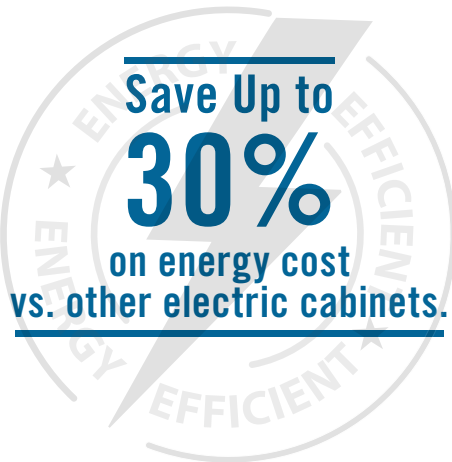

Rust-Free and
Quiet Nylon
Casters

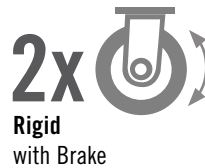
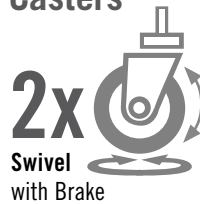

MODULE
ONLY

Holding Capacity

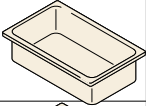
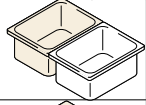
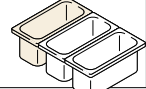
GN FOOD PANS	FOOD PAN DEPTH			
	6,5 cm	10 cm	15 cm	20 cm
GN 1/1 	12	8	6	4
GN 1/2 	24	16	12	8
GN 1/3 	36	24	18	12

HOT & COLD
in the same cart,
at the same time



CODE	DESCRIPTION	DIMENSIONS W x D x H
PCUS800HH	Hot/Hot Unit	59,2 x 81,2 x 165,2 cm
PCUS800HC	Hot/Cold Unit	59,2 x 81,2 x 165,2
PCUS800CC	Cold/Cold Unit	59,2 x 81,2 x 165,2
PCMCX	Cold Module	—
PCMHX	Hot Module	—

Case Pack: 1 Cabinet Color: Stainless Steel (000). Module Color: Charcoal Gray (615).
Voltage/Phase: 220V/Single, EU/UK Plug Cord.
Modules transition to standby mode when optimal temperature is reached, saving energy.

Customize Your Food Pan Transporter to Match Your Needs



Hot Module PCMHX

- Safely maintain food temperatures between 65,6°C to 73,9°C with gentle, non-radiant heat
- Adjustable temperature to maximum of 85°C
- Heats from room temperature to 73,9°C in 15 minutes



Cold Module PCMCX

- Thermoelectric cooling technology is safe for transport
- Cools down to 0,3°C without a compressor
- Adjustable temperature to 0,3°C



*Average recovery time based on ambient temperature of 23,3°C, empty compartments - Door open for 30 seconds.

Easy
Change
Modules

Electrical Specifications (Per Compartment)



	HOT MODULE	COLD MODULE
REQUIRED VOLTAGE	115-230 VAC	115-230 VAC
AMPS	3.19a @ 115v 2.17a @ 220v	3.6a @ 115v 1.7a @ 230v
WATTS	450w @ 115v 500w @ 230v	414w @ 115v 393w @ 230v
HERTZ	50/60	50/60
PHASE	Single	Single
PLUG BODY FOR THESE COUNTRIES ADD COUNTRY CODE TO PRODUCT CODE WHEN ORDERING	4:Europe 5:UK	



If country is not listed, please call Cambro Customer Service for details.

PRO CART ULTRA® – ELECTRIC & NON-ELECTRIC

INSULATED HOLDING & TRANSPORT CABINETS

The Pro Cart Ultra is the ultimate food transport cart that can hold all your hot and cold menu items in the same cart, at the same time—without a compressor!

- Hold and transport hot and cold foods in a single cart.
- Maintains food quality and moisture.
- Keep food safe while unplugged 4 hours.
- Change hot to cold or cold to hot with a simple hardware change.
- Universal rails fit food pans, sheet pans and more.



Color: Charcoal Gray (615).

Multiple International Certifications available.

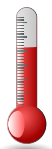

ELECTRIC HOT

Hot holding cycles between 65,5° - 74°C.



NON-ELECTRIC PASSIVE

Holds hot or cold foods for 4 + hours.

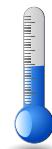

ELECTRIC COLD

Cold holding cycles between 0,3° - 4,4°C without a compressor.



Hot, cold and passive modules are also sold separately to quickly outfit the cart to suit your menu.

Temperature Retention of Passive and Unplugged Electric Models

Hot — temperature loss averaging 1,5°C/hour.

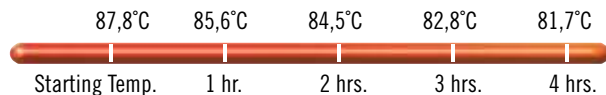

Cold — temperature gain averaging 0,4°C/hour.

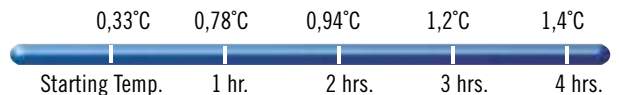

Capacity per Compartment

TYPE OF CONTAINER	STANDARD CAPACITY	STANDARD CAPACITY RAIL SPACING
45,7 x 66 CM FULL SIZE SHEET PANS	5	7,62 cm
33 x 45,7 CM HALF SIZE SHEET PANS	10	7,62
GN 1/1 HOTEL PANS (6,5 CM DEEP)	10	11,43
GN 1/1 HOTEL PANS (10 CM DEEP)	10	11,43
60 x 40 CM EURO BAKING SHEETS	5	7,62
54,6 x 33,6 x 6,35 CM BASKETS	10	7,62
40,6 x 40,6 x 5,1 CM PIZZA BOXES	5	7,62

Standard rails: 5 rails / compartment *Additional rails required.



Adjustable rails can be set in any position and easily changed when needed.

PRO CART ULTRA® – FEATURES AND TOW HITCH KIT

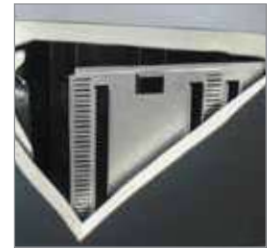

INSULATION
CFC-free, polyurethane insulation throughout the body and doors maximizes heat or cold retention for 4 hours or more with no electricity needed.



10 CM NYLON LATCHES AND ADJUSTABLE HINGES
For easy opening and closing and to secure contents during transport. (Door is lockable).

GASKET-FREE DOOR
For easy cleaning and fewer replacement parts. Door opens full 270°.

SOLAR DIGITAL THERMOMETER
Monitor internal cabinet temperature at a glance.



12,7 x 20,3 CM MENU POCKET
Allows for easy product ID with either an index card or by writing directly onto smooth surface with a grease pencil.

STAINLESS STEEL HINGE
For long term durability.

POLYETHYLENE EXTERIOR
Keeps food moist naturally and remains cool to the touch during operation, unlike metal cabinets.

STANDARD 15 x 5 CM HEAVY DUTY CASTERS
Two non-marking, high-performance, all swivel casters with brakes in the front and two rigid casters in the back for smooth positioning and navigation.

Pro Cart Ultra Tow Hitch Kit

Tow your Pro Cart Ultra to your loading dock, serving location and back to your kitchen with the Cambro Tow Hitch Kit. The tow hitch is designed to securely connect your Pro Cart Ultra to any service vehicle with towing capability.

- Fits all Pro Cart Ultra models, low and tall.
- Kit available with standard or security hardware.
- Maximum tow capacity 907 kg.



CODE	DESCRIPTION	UNIT WEIGHT
PCUTOW	Pro Cart Ultra Tow Hitch	15,87 kg
PCUTOWSP	Pro Cart Ultra Tow Hitch Security Package	15,87

Case Pack: 1 Color: (000). SP package includes tamper-resistant screws.



PRO CART ULTRA® – ELECTRIC

Powerful Performance, Low Power Consumption

- Energy efficient, active modules draw less than 5 amps each.
- Cold module uses environmentally friendly, thermoelectric technology.
- Plugs into a standard outlet.

COLD

Digital controller allows cold to be set from 0,3° to 4,4°C.

Thermoelectric Cooling Down to 0,3°C

Cool without a compressor for the ultimate in cold mobility and food safety on the go.

Note: Operate in 90°F or less ambient temperature for best results.

Pre-chill time:

90 minutes to 4,4°C.
(Tested at 23°C ambient.)

Recovery time:

10 minutes after door open for 30 seconds.



Interior with Cold module



Exterior back with Cold module

HOT

Keeps food safely between 65,5° to 74°C with convenient, pre-set, gentle, non-radiant heat.

Energy-Saving Heater Less Than 5 Amps

Gentle, non-radiant heat circulates consistently from front to back of the cabinet.

Pre-heat time:

45 minutes.

Recovery time:

3 minutes after door open for 30 seconds.



Interior with Hot module



Exterior back with Hot module

Just 5 Minutes to Change Module

- Seasonal menus
- Menu changes
- Additional budget availability
- Different location or facility
- New trends



Electrical Specifications (Per Compartment)

	HOT 110V	HOT 220V	COLD
REQUIRED VOLTAGE	100-125 VAC	200-230 VAC	100-230 VAC
MAXIMUM AMP	4.6a	2.3a	3.26a, 1.42a
WATTS / HEATER OR COOLER	529w	506w	326.6w
HERTZ	50/60	50/60	50/60
PHASE	Single	Single	Single
ALTERNATE PLUG TYPES FOR INTERNATIONAL	US, Canada, Mexico, Europe, UK, Ireland, Australia, South Africa, China, Japan		
POWER CORD LENGTH	2,7 m	2,7 m	2,7 m



PRO CART ULTRA® – MODEL SPECIFICATIONS



	CODE	DESCRIPTION	UNIT WEIGHT
TALL PROFILE 	Both compartments non-electric / passive		
	PCUPP	Both compartments non-electric / passive	106,7 kg
	Both Compartments Hot		
	PCUHH	110V	121,3
	PCUHH*	220V	121,7
	Both Compartments Cold		
	PCUCC	110V	126,3
	PCUCC*	220V	128,7
	Combination Hot & Cold		
	PCUHC	Top compartment hot, bottom cold. 110V	122,9
	PCUCH	Top compartment cold, bottom hot. 110V	122,9
	PCUHC*	Top compartment hot, bottom cold. 220V	123,1
	PCUCH*	Top compartment cold, bottom hot. 220V	123,1
	Combination Passive & Hot or Cold		
	PCUPH	Top compartment passive, bottom hot. 110V	155,8
	PCUPC	Top compartment passive, bottom cold. 110V	188,3
	PCUPH*	Top compartment passive, bottom hot. 220V	116
	PCUPC*	Top compartment passive, bottom cold. 220V	119,5
LOW PROFILE 	PCULP	Non-electric / passive	63,5
	PCULH	Hot Cart, 110V	68,5
	PCULC	Cold Cart, 110V	70,8
	PCULH*	Hot Cart, 220V	68,5
	PCULC*	Cold Cart, 220V	70,8

3	US/CAN/MEX
4	EU
5	UK
6	AU
7	SA
8	JAPAN
9	CHINA

*Use number to select plug for your country's electrical requirement.

STOCK PRODUCTS & COLORS AVAILABLE IN OUR EUROPEAN WAREHOUSE

PCUCC4, PCUCC5, PCMH4 PCMH5: (615)

Case Pack: 1 **Color:** Charcoal Gray (615). **Standard Railing Includes:** 5 pairs of stainless steel Universal rails/compartments. **Includes Standard Casters:** 15 x 5 cm heavy duty swivel with brake in front, rigid in back.

Unit Dimensions

UNIT	EXTERIOR DIM. W x D x H	COMPARTMENT DIM. W x D x H
Tall Profile		
COLD	71,1 x 92,7 x 167,6 cm	53,7 x 66,7 x 64,8 cm
HOT / PASSIVE	71,1 x 90,8 x 167,6	53,7 x 68,6 x 64,8
Low Profile		
COLD	71,1 x 92,7 x 101,6	53,7 x 68,6 x 64,8
HOT / PASSIVE	71,1 x 90,8 x 101,6	53,7 x 68,6 x 64,8

Optional Accessories

CODE	DESCRIPTION
PCMH*	Hot module unit 110V / 220V
PCMC*	Cold module unit 110V / 220V
SSR1	1 Pair of Rails
SSR5	5 Pairs of Rails

Case Pack: 1 **Module Unit Color:** Charcoal Gray (615).

Security Package (SP)

Specially designed for operations where safety and security are a top priority. To order add SP after the product code or visit cambro.com for a listing of codes.

- Tamper resistant fasteners secure side column panels to the cart.
- Cross locking rods behind column panels lock 5 rails in place.
- Each compartment holds ten 10 cm deep hotel pans.
- Passive and electrical modules and cord strap keepers are secured in place with tamper resistant fasteners.
- Non removable doors. Lockable hasp secures both doors at once. (Lock not included).
- Heavy duty casters mounted with tamper resistant fasteners.



INSULATED BEVERAGE CONTAINERS

- Use to hold, transport and serve hot or cold beverages.
- One piece, seamless double-wall polyethylene with thick foam insulation.
- Sturdy latches secure lids tightly and will never rust.
- Drip-proof recessed spigot for easy self-serve access.
- Stack units on riser to fill large cups or coffee pots.
- Sta-stack interlocking ensures stable stacking during transport and storage.

Easy Serve Dispenser Color:
Black (110).

UC1000 covered by U.S. Patent
D 403,916.

Vent Cap patent pending.



Vent Cap
Equalizes pressure. Makes the opening of the container much easier.

E-Z Grip Molded-in Handles
For comfortable, safe transporting.

Camtainer Cover

Durable and attractive covers extend the life of your Camtainers and fit in any serving environment.

Personalization available. Contact your Cambro representative for details.



Recessed Faucet
Accommodates larger cups. Allows even dispensing and eliminates drips. Two positions: One for continuous pouring and one for individual dispensing.



Molded-in Metal Backing Plates
Prevents latches from breaking away from the container.



Stack beverage servers during storage and transporting to save space.

Stacking options:

- 100LCD with 100LCD
- All 250, 350 and 500 units
- UC1000 and 1000LCD

Hot

250LCD	87°C	84,5°C	82°C	79°C	77°C
UC250	88°C	85,5°C	84°C	82°C	80°C



Starting Temperature 1 hr. 2 hrs. 3 hrs. 4 hrs.

Cold

250LCD	1°C	1,5°C	2°C	3°C	4°C
UC250	0,5°C	1°C	1°C	1,5°C	2°C



Starting Temperature 1 hr. 2 hrs. 3 hrs. 4 hrs.



Ultra Camtainers®
Feature wide nylon latches which are easy to open and close with one hand.



Camtainers®
Feature sturdy plastic latches that secure lids tightly and will never rust.

Ultra Camtainers®

Choose from three sizes for beverage service. A contemporary line, featuring two wide nylon latches per unit that are easy to open and close.

STOCK PRODUCTS & COLORS AVAILABLE IN OUR EUROPEAN WAREHOUSE

UC250, UC500: (401), (191), (110)
UC1000: (401), (110)



CODE	UC250	UC500	UC1000
CAPACITY	10,4 L	19,9 L	39,7 L
210 ML. CUPS	50	96	192
EXTERIOR DIMENSIONS D x W x H	42,5 x 30 x 50 cm	42,5 x 30 x 68 cm	52 x 41,5 x 65,5 cm
FITS CAMDOLLY	CD100H, CD1826H, CD300H, CD100HB, CD300HB, CD100	CD100H, CD1826H, CD300H, CD100HB, CD300HB, CD100	CD300H, CD1826H, CD2020H, CD100HB, CD300HB, CD1826MTCHB, CD300, CD2020
CAMTAINER COVER	UC250CVR	UC500CVR	UC1000CVR

Case Pack: 1 Colors: Navy Blue (186), Slate Blue (401), Coffee Beige (157), Dark Brown (131), Brick Red (402), Green (519), Black (110), Granite Grey (191), Granite Green (192), Granite Sand (194). Cover Color: Black (110). Venting plug is covered by US Patent D 553,717 S.

Camtainers®

The standard for many caterers, choose from four sizes for beverage service and one model without a spigot for soup service. Four sturdy plastic latches on each unit open and close easily and will never rust.

STOCK PRODUCTS & COLORS AVAILABLE IN OUR EUROPEAN WAREHOUSE

250LCD, 350LCD, 500LCD: (157), (401)
100LCD: (401)



CODE	100LCD	250LCD	500LCD	1000LCD	350LCD (SOUP)
CAPACITY	5,7 L	9,5 L	17,9 L	44,5 L	12,7 L
210 ML. CUPS	27	45	85	214	60
SPIGOT	YES	YES	YES	YES	—
EXTERIOR DIMENSIONS D x W x H	29 x 26,5 x 44 cm	42 x 23 x 46,7 cm	42 x 23 x 62 cm	53 x 41,5 x 63 cm	42 x 23 x 46,7 cm
FITS CAMDOLLY	CD1420	CD100H, CD1826H, CD300H, CD2020H, CD100HB, CD300HB, CD1826HB, CD2020HB, CD100, CD2020	CD100H, CD1826H, CD300H, CD2020H, CD100HB, CD300HB, CD1826HB, CD2020HB, CD100, CD2020	CD300H, CD1826H, CD2020H, CD100HB, CD300HB, CD1826MTCHB, CD300, CD2020	CD100H, CD1826H, CD300H, CD2020H, CD100HB, CD300HB, CD1826HB, CD2020HB, CD100, CD2020
CAMTAINER COVER	—	250LDCVR	500LDCVR	1000LDCVR	—

Case Pack: 1 Colors: Navy Blue (186), Slate Blue (401), Coffee Beige (157), Dark Brown (131), Brick Red (402), Green (519), Black (110), Hot Red (158). Cover Color: Black (110). Venting plug is covered by US Patent D 553,717 S.

Camserver® – Holds The Heat for Hours.

- A front-of-house beverage server for hot or cold beverages that does not require canned heating.
- Double-wall polyethylene shell with thick foam insulation retains temperatures for hours.

Colors: Black (110), Dark Taupe (417), Granite Grey (191).



Convenient top-fill opening for fast replenishment without removing lid.

CODE	EXTERNAL DIM. H x W x D	CAPACITY	210 ML CUPS	CASE PACK
CSR3	60 x 34 x 46,5 cm	11,5 L	54	1
CSR5	71 x 34 x 46,5	19	91	1

CSR3 Shown in Dark Taupe Height is approximate 18 cm from counter to spigot.



CSR5 Shown in Black

BEVERAGE SERVICE CARTS

- Ideal for breakfast, coffee or snack service.
- Use top counter to hold Cambro Beverage Servers, Versa Organizer Bins or Display Trays with Covers for food.
- Store drinkware, additional food items or other supplies in open compartment.
- Insulated cabinets hold hot or cold food in 1/1, 1/2 or 1/3 size food pans or on Cambro Metric Camtrays® (3253).

Colors: Slate Blue (401), Granite Grey (191), Granite Green (192).

See Organizer section for more information on Organizer Bins.

See Camtainer section for more information on Camtainers.

Wire Rack Color: Silver (000).

See Cold Pack section for more information on Cold Packs.

15,2 cm Casters: 2 fixed, 2 swivel, 1 with brake.

For complete specifications, call or write Cambro.



Beverage Service Cart is designed to hold Beverage Containers at point of service only. A dolly or hand truck with safety strap is recommended for moving Beverage Containers over longer distances or uneven surfaces.



MDC24F

STOCK PRODUCTS & COLORS AVAILABLE IN OUR EUROPEAN WAREHOUSE

5412CBP: (131), (480)
100LCD: (401)

CODE	EXTERIOR DIM. L x W x H	CASE PACK
MDC24	113 x 76 x 112 cm	1
MDC24F	113 x 76 x 112	1
OPTIONAL ACCESSORIES		
Organizer Bin		
5412CBP	30,5 x 13 x 11	12
Camtainer®		
100LCD	26,5 x 30 x 44	1
Wire Rack		
MDC24R	58,4 x 43,2 x 35,5	1
Camchiller®		
CP3253	53 x 32,5 x 3	1

The use of racks in the MDC24 and MDC24F carts will allow the following configuration of pans or trays, per compartment:

DESCRIPTION	GN 1/1	GN 1/2	GN 1/3
6,5 cm Pans	(4) 12CW	(8) 22CW	(12) 32CW
10 cm Pans	(3) 14CW	(6) 24CW	(9) 34CW
15 cm Pans	(2) 16CW	(4) 26CW	(6) 36CW
20 cm Pans	(1) 18CW**	(2) 28CW**	(3) 38CW**

**With room for 6,5 cm or 10 cm pan above 15 cm pan.
10 each 3253 Metric Camtrays®.

Compartment Dimensions

Shelf Compartment	W 96,5 cm	D 64 cm	H 25,4 cm
Holding Compartments	W 44,5 cm	D 60,3 cm	H 36 cm

Venting plug is covered by US Patent D 553,717 S.



MDC24 has recessed top that holds 3 each 3,8 Liters 100LCD Camtainers and stacked Condiment Bins & Wire Rack with 3253 trays.

MDC24R Wire Rack

Wire Rack (sold separately) to organize pans and trays in the cart. Rack holds 1/1, 1/2 and 1/3 size Food Pans and 3253 trays. When placed in cart's core area, the rack allows room on either side of pan positions for Cambro's CP3253 Camchillers® one on each side.



MOBILE HANDWASH STATION

Approx.

200

handwashings
per tank



Completely
Hands-Free
Operation



Requires

**NO plumbing
or electricity**
to operate.

MHWS18

53,5 x 48 x 161,5 cm

MHWS18PER100 (with graphics wrap)



Store
Safe

MORE
INFC 



3-IN-1 HANDWASHING STATION

Paper towel and
soap dispenser

100 Liter Camtainer® with
Easy Serve Dispenser

Riser

HWS31

MORE
INFC 



HAND SINK CART

With electric water pump and heater

KSC402 (110 volt only)
103 x 84 x 116 cm

MORE
INFC 

HANDWASH ACCESSORY –

FOR CAMTAINERS® AND ULTRA CAMTAINERS®

- Set up a Handwashing Station quickly and easily on or off premise.
- Convenient and economical way to meet health department hand washing requirements.
- Attaches to Camtainers 250LCD, 500LCD or Ultra Camtainers UC250, UC500.
- Includes four Handwash Only labels and an Easy Serve Dispenser lever.

Handwash Accessory Stocking Colors:
Dark Brown (131), Black (110).

Easy Serve Dispenser Color: Black (110).

Riser Colors: See optional accessories with Camtainers.

Pail with Bail Color: White (148).

Handwash Accessory is covered by the following U.S. Patent D 506,634 S & D 506,899 S.



Shown with 500LCD Camtainer.



CODE	HWAPR	HWATD
DESCRIPTION	With paper towel roll holder	With multi-fold paper towel dispenser
FITS	250LCD, 500LCD, UC250, UC500	250LCD, 500LCD, UC250, UC500

Optional Accessories



CODE	R500LCD	R1000LCD	LCDCH	LCDCH10
DESCRIPTION	Riser	Riser	Condiment Holder	Condiment Holder
EXTERIOR DIM. D x W x H	41,5 x 23 x 12 cm	49,5 x 39 x 11,5 cm	42 x 22 x 13 cm	51 x 41 x 12 cm
FITS	250LCD, 500LCD, UC250, UC500	1000LCD, UC1000	250LCD, 500LCD UC250, UC500	1000LCD, UC1000

Case Pack: 1 Colors: Coffee Beige (157), Dark Brown (131), Black (110).



CODE	PWB22	LCDES
DESCRIPTION	Pail with Bail	Easy Serve Dispenser
FITS	—	LCD Spigots UC Spigots
CASE PACK	6	1

CVC75 MOBILE FOOD VENDING CART



with
Safety-First Design

Versatile and durable mobile solution provides maximum menu flexibility, indoors and outdoors.





CVC75

MOBILE FOOD VENDING CART



3 Open Storage Compartments

Perfect for restock with Cambro EPP GoBoxes



Open well design — configure your ingredients and menu items for peak serving efficiency



Add optional levels to the standard 30 cm Safety Barrier increase merchandising space and operator safety



End Table available facilitate a fast service

All Weather Vinyl Wrap

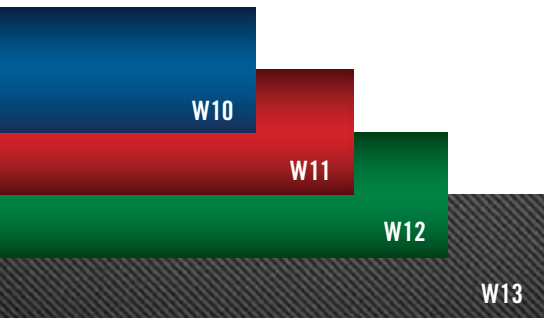

* All CVC75 carts come with a vinyl wrap

Build Your Own Cart

Let's Get Personal!

Whether it's your logo on one of our standard wraps or a fresh new design, wrap customization is available - consult your local Cambro representative



CVC75 MOBILE FOOD VENDING CART



Dimensions and Product Codes

CODE	DESCRIPTION	OVERALL EXTERIOR DIMENSIONS L x W x H	FULL PAN SIZE CAPACITY
CVC75	Vending base unit with safety barrier	190,5 x 85 x 135 cm	5
CVC75B	Vending base unit only	190,5 x 85 x 95 cm	5
Optional Accessories*			
CVC75DC6	15,2 cm tall merchandising display	—	—
CVC75DC12	30,3 cm tall merchandising display	—	—
CVC75DCE6	15,2 cm tall merchandising display extender	—	—
CVC75DCE12	30,5 cm tall merchandising display extender	—	—
CVC75LET	40,6 cm left side end table	—	—
CVC75RET	40,6 cm right side end table	—	—
CVC75LSRL	Set of two adjustable lower cabinet shelves	—	—

Case Pack: 1 **Color:** Black (110). *All accessories only available in Black (110).

VERSA FOOD SERVICE SYSTEM



The Versa Food Service System provides custom design without the custom price. This non electric, versatile, portable system keeps food cold for hours with either ColdFest® pans or Buffet Camchillers®. The system is made of durable all-weather material and is easy to clean. The Versa Food Service System offers countless configurations to fit any foodservice need.

- Ergonomic, molded-in handles on both sides ensure easy maneuvering.
- Versa Food Bar and Work Table both include a drain faucet that can be connected to a hose for drainage and easy cleaning.
- Add an end table to a Food Bar or Work Table to hold trays, condiments, or paper goods.

Versa Cart

- Join a Versa Cart with a Food Bar or Work Table for fast check-out and improved traffic flow.
- The Versa Cart includes an adjustable shelf, standard lockable drawer and convenient electrical access through the top of the cart and front design panel.
- Optional Tray rails easily adjust to a lower height.
- Optional pull-out keyboard tray fits inside the drawer.



Versa Food Service System is covered under U.S. Patent 9,084,498 B2.



All components are fully compliant with NSF requirements.



Versa Straight Connector and Versa Corner Connector

Easily and safely attach multiple components together to create a contiguous system and maximize space and merchandising options.

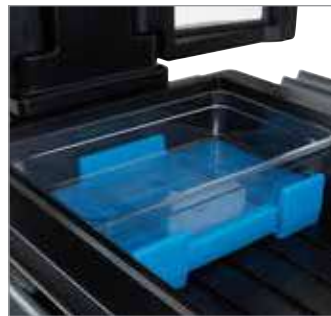

Buffet Camchillers

Extend safe, cold holding time without ice. Dual-sided Buffet Camchillers hold 6,5 cm and 10 cm pans. Fits in the Versa Food Bar, Versa Work Table and Table Top Food Bars.

VERSA FOOD SERVICE SYSTEM

Whether you're looking to maximize space, improve traffic flow, add merchandising space or create an upscale salad bar, the Versa Food Service System has you covered.



NSF **BPA FREE**
All components are fully compliant with NSF requirements.

Versa Food Bar®
As Shown: VBR5 shown with optional 2-VCS32R, 1-VBRTBL.



VBRT5



Standard height model.

Versa Work Table

- Perfect for a prep table, display, self-serve station or back bar.
- Attach a Work Table to a Food Bar to merchandise snacks and beverages.
- Matching well covers are included with each Versa Work Table.

VERSA BAR AND VERSA WORK TABLE

- Now available with two secure storage cabinets that can hold up to 22,7 kg per compartment of non-perishable items.



Scan QR code for package product code.



VBRUT5



VBRTBL

VCS32R

VBR6 with optional 2-VBRR6, 2-VBRTBL

Storage Dimensions:
L 54,61 x W 44,45 x H 45,72 cm per cabinet.
Each cabinet is 0,11 M³.

NSF **BPA FREE**
All components are fully compliant with NSF requirements.



VERSA FOOD SERVICE SYSTEM

CODE	DESCRIPTION	OVERALL EXTERIOR DIMENSIONS L x W x H	FULL PAN SIZE CAPACITY	WELL INTERIOR DIMENSIONS L x W x H
Versa Food Bars® – Standard Height				
VBR5	152 cm with standard casters	175,3 x 108 x 159,4 cm	4	132,8 x 53,3 x 18 cm
VBRHD5	152 cm with heavy duty casters	175,3 x 108 x 159,4	4	132,8 x 53,3 x 18
VBR6	183 cm with standard casters	208,3 x 108 x 159,4	5	165,4 x 53,3 x 18
VBRHD6	183 cm with heavy duty casters	208,3 x 108 x 159,4	5	165,4 x 53,3 x 18
Versa Food Bars Ultra Series – Standard Height				
VBRU5	152 cm with standard casters and storage	175,3 x 108 x 159,4	4	132,8 x 53,3 x 18
VBRUHD5	152 cm with heavy duty casters and storage	175,3 x 108 x 159,4	4	132,8 x 53,3 x 18
VBRU6	183 cm with standard casters and storage	208,3 x 108 x 159,4	5	165,4 x 53,3 x 18
VBRUHD6	183 cm with heavy duty casters and storage	208,3 x 108 x 159,4	5	165,4 x 53,3 x 18
Versa Food Bars – Low Height				
VBRL5	152 cm with standard casters	175,3 x 108 x 141,6	4	132,8 x 53,3 x 18
VBRLHD5	152 cm with heavy duty casters	175,3 x 108 x 141,6	4	132,8 x 53,3 x 18
VBRL6	183 cm with standard casters	208,3 x 108 x 141,6	5	165,4 x 53,3 x 18
VBRLHD6	183 cm with heavy duty casters	208,3 x 108 x 141,6	5	165,4 x 53,3 x 18
Versa Work Tables – Standard Height				
VBRT5	152 cm with standard casters	175,3 x 68,6 x 92,1	4	132,8 x 53,3 x 18
VBRTHD5	152 cm with heavy duty casters	175,3 x 68,6 x 92,1	4	132,8 x 53,3 x 18
VBRT6	183 cm with standard casters	208,3 x 68,6 x 92,1	5	165,4 x 53,3 x 18
VBRTHD6	183 cm with heavy duty casters	208,3 x 68,6 x 92,1	5	165,4 x 53,3 x 18
Versa Work Tables Ultra Series – Standard Height				
VBRUT5	152 cm with standard casters and storage	175,3 x 68,6 x 92,1	4	132,8 x 53,3 x 18
VBRUTHD5	152 cm with heavy duty casters and storage	175,3 x 68,6 x 92,1	4	132,8 x 53,3 x 18
VBRUT6	183 cm with standard casters and storage	208,3 x 68,6 x 92,1	5	165,4 x 53,3 x 18
VBRUTHD6	183 cm with heavy duty casters and storage	208,3 x 68,6 x 92,1	5	165,4 x 53,3 x 18
Versa Work Tables – Low Height				
VBRTL5	152 cm with standard casters	175,3 x 68,6 x 74,3	4	132,8 x 53,3 x 18
VBRTLHD5	152 cm with heavy duty casters	175,3 x 68,6 x 74,3	4	132,8 x 53,3 x 18
VBRTL6	183 cm with standard casters	208,3 x 68,6 x 74,3	5	165,4 x 53,3 x 18
VBRTLHD6	183 cm with heavy duty casters	208,3 x 68,6 x 74,3	5	165,4 x 53,3 x 18

Case Pack: 1

CODE	DESCRIPTION	OVERALL EXTERIOR DIMENSIONS L x W x H
Versa Cart		
VCSWR	With dual tray rails and standard casters	134 x 81,9 x 109,2 cm (with tray rails up)
VCSWRHD	With dual tray rails and heavy duty casters	134 x 81,9 x 109,2 (with tray rails up)
VCS	With standard casters and no tray rails	81,3 x 81,9 x 109,2
VCSHD	With heavy duty casters and no tray rails	81,3 x 81,9 x 109,2
Connectors		
VBRC	Straight connector - food bar to food bar	68,6 x 48,3 x 10,8
VBRC90	Corner connector - food bar to food bar	91,4 x 91,4 x 10,8
VCS32CNT	Straight connector - cart to standard height food bar / work table	68,6 x 51,75 x 8,26
VCSCNL	Straight connector - cart to low height food bar / work table	68,6 x 51,75 x 21,59

Case Pack: 1 Versa Food Bar, Versa Work Table, Versa Cart, Connectors, Well Cover Colors: Black (110), *Hot Red (158), *Navy Blue (186), *Kentucky Green (519).

Tray Rail and End Table Colors Only: Granite Gray (191), **Black (110).

*Made to order colors for Versa Food Bar, Versa Work Table, Versa Cart, Connectors, Well Cover, Tray Rail and End Table.

**Made to order color for Tray Rail and End Table only. Made to order items not carried in stock, non-returnable.

FOOD BAR ACCESSORIES

Every Accessory You Need

- Crock and Salad Bowl Holders highlight and organize salads, condiments and dressings.
- Tray Rails offer convenience for your patrons.

See Camwear® Food Pans and Crocks section for more information.

Versa Cart with Dual Tray Rails

(VCSWR & VCSWRHD): All orders receive the tray rails in Granite Gray (191). To choose a different color tray rail you must order the Versa Cart Without Rails (VCS or VCSHD) and the tray rails (VCS32R) separately.

Connector Colors: Black (110), Hot Red (158), Navy Blue (186), Kentucky Green (519).

Vinyl Cover Color: Opaque (000).

Sign Holder Color: Clear (152).

Buffet Camchiller® Color:

Cold Blue (159).

Divider Bar Colors: White (148), Clear (152).

Well Cover Colors: Black (110), Hot Red (158), Navy Blue (186), Kentucky Green (519).

Keyboard Tray Color: Black (110).

Crock, Salad Bowl Holders Colors: White (148), Granite Gray (191).

Versa Food Bar is covered under U.S. Patent D 615,323 S and D 620,730. Versa Food Bar Ultra Series is covered under U.S. Patent D702,066 S. Versa Cart is covered under U.S. Patent D 653,830 S. Buffet Camchiller is covered under U.S. Patent D 618,4765 S. All other parts patent pending.

*Items are not NSF Listed.



- 183 cm models hold 5 full size Pans with Divider Bars.
- 152 cm models hold 4 full size Pans with Divider Bars.

- Fractional Size Pans can be used in many variations with Divider Bars. Mix and match sizes to fit your needs.

Two Salad Bowl Holder models available, SBH18 and SBH15. Crock Holder, CPH3, holds 1,4 and 2,6 L crocks.

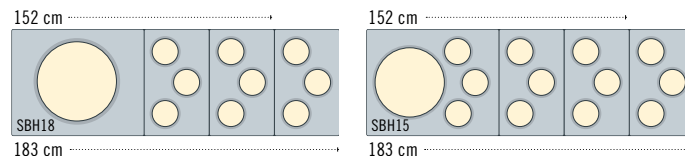

- 183 cm models hold a Salad Bowl Holder and 3 ea. Crock Holders.
- 152 cm models hold a Salad Bowl Holder and 2 ea. Crock Holders.

CODE	DESCRIPTION	OVERALL EXTERIOR DIMENSIONS L x W x H	CASE PACK
VBRR5	Tray rail for 152 cm - Versa Food Bar / Versa Work Table	134,6 x 29,2 x 11,6 cm	1
VBRR6	Tray rail for 183 cm - Versa Food Bar / Versa Work Table	167,6 x 29,2 x 11,6	1
VCS32R	Tray rail for - Versa Cart	71,12 x 29,7 x 12,7	1
VBRTBL	End table for Versa Food Bar and work table	68,6 x 55,88 x 11,43	1
VBRCVR5*	Vinyl cover for 152 cm Versa Food Bar	185,4 x 110,5 x 116,8	1
VBRCVR6*	Vinyl cover for 183 cm Versa Food Bar	210,8 x 110,5 x 116,8	1
VBRTCVR5*	Vinyl cover for 152 cm Versa Work Table	177,8 x 85,1 x 53,3	1
VBRTCVR6*	Vinyl cover for 183 cm Versa Work Table	210,8 x 85,1 x 53,3	1
VCSCVR*	Vinyl cover for Versa Cart	106,7 x 83,8 x 91,4	1
VBRSHTS*	Versa Food Bar sign holder	91,4 x 15,2 x 23,5	1
DIV12	30,5 cm divider bars	32,39	3
DIV20	51 cm divider bars	53,02	3
CPH3	Crock holder holds 1,4 & 2,6 L	L 33 x W 53	1
SBH15	Salad bowl holder holds a 38,1 cm bowl and 3 crocks	L 65,5 x W 53	1
SBH18	Salad bowl holder holds an 45,7 cm bowl	L 65,5 x W 53	1
CPB1220	Buffet Camchiller for Versa Food Bars, Work Tables and table top food bars	46,99 x 32,07 x 10,16	1
VBRWC	Versa well cover for Versa Food Bar/Work Table	53,02 x 33,02 x 5,08	1
VCS32KEYT	Versa Cart keyboard tray	52,4 x 25,71 x 5,08	1

Versa Food Bar includes Versa Food Bar with and without cabinet.

TABLE TOP FOOD BARS, BUFFET BARS & SNEEZE GUARDS



Table Top Food Bars

- Turn a 122-183 cm table into a double-sided self service buffet or beverage station.
- Thick, foam-insulated well keeps food cold for hours with Buffet Camchillers or ice.
- Drain plug allows for quick and easy clean-up.

Buffet Bars

- Ideal for holding snacks and cold beverages.
- The Buffet Bar with Sneeze Guard is perfect for single-sided, self-serve buffets.

Food Bar Colors: Black (110), Navy Blue (186), Kentucky Green (519), Hot Red (158).

Crock Holder and Salad Bowl Holders available in White (148), Granite Gray (191), Sandstone (614).

BUF48 and BUF72 are NSF listed.

NSF listed for non-direct food contact only.



4FBRTT Table Top Food Bar
Buffet Camchiller® available.



BBR480 Buffet Bar with Sneeze Guard



BUF48 Buffet Bar Base

Merchandises soft drinks on ice to increase beverage sales.

CODE	OVERALL EXTERIOR DIMENSIONS L x W x H	FULL SIZE PAN CAPACITY	WELL INTERIOR DIMENSIONS L x W x D
Table Top Food Bars			
6FBRTT	181,6 x 84,5 x 68,6 cm	5	159,7 x 51,1 x 16,5 cm
5FBRTT	161,3 x 84,5 x 68,6	4	127,2 x 51,1 x 16,5
4FBRTT	129,5 x 84,5 x 68,6	3	94,6 x 51,1 x 16,5
Buffet Bars			
BUF72	171,5 x 61 x 17,8	5	159,7 x 51,1 x 12,7
BUF48	106,2 x 61 x 17,8	3	94,6 x 51,1 x 12,7
Buffet Bars w/Sneeze Guard			
BBR720	187,6 x 61,3 x 62,2	5	159,7 x 51,1 x 12,7
BBR480	121,9 x 61,3 x 62,2	3	94,8 x 51,1 x 12,7

Case Pack: 1

CAMKIOSK® SYSTEM – EVERY EVENT OR LOCATION IS AN OPPORTUNITY FOR PROFITS



- Build sales off premise and in non-traditional locations.
- Two insulated food storage cabinets maintain safe hot or cold food and/or beverage temperatures for hours.
- Use optional well covers to cover food pan wells and increase countertop space.
- Durable, all-weather polyethylene exterior with foam insulation will not crack, dent, bubble, chip, rust or break.
- Heavy duty 15,2 cm casters roll smoothly from kitchen to location then lock in place.

CAMKIOSK® CARTS



Telescoping poles enable canopy to lower 30,5 cm for quick and easy storage.



KVC854C Cart with 4 pan wells & canopy.



Camchillers® keep cold packaged foods cold during transport and service when placed directly on top of food pan wells or at the top of the CamKiosk's insulated holding cabinet.

Cart Colors

- 186 Navy Blue
- 158 Hot Red

Canopy Color

- 157 Beige

Cart Colors

- 191 Granite Grey
- 192 Granite Green
- 519 Kentucky Green
- 426 Black Base with Granite Grey Top & Doors

Canopy Color

- 519 Kentucky Green

Personalize your CamKiosk Cart to promote your brand.

CANOPY TRIM AND TOP PANEL

(Charges per side)

- One Color** **
- Two Color** **
- Three Color** **

FRONT DISPLAY PANEL

(Cruising Café® panel standard)

- Set Up Charge per Panel** **
- Charge per Color** **

**Contact your Cambro representative for pricing.



4 well top



6 well top

Well Cover Colors: Black (110), Hot Red (158), Navy Blue (186), Kentucky Green (519), Granite Grey (191), Granite Green (192).

15,24 cm Casters: 2 fixed, 2 swivel, 2 with brake.

Cutting Board Color: White (148).

Camchiller Color: Glacier Blue (433).

ThermoBarrier Color: Slate Blue (401).



Camchiller & ThermoBarrier

CODE	FULL SIZE PAN WELLS	OVERALL DIMENSIONS L x W x H
CamKiosk Carts		
KVC854	4	216 x 85 x 179 cm
KVC854C	4	216 x 85 x 239
KVC856	6	216 x 85 x 179
KVC856C	6	216 x 85 x 239
C: Canopy		

Holding Capacity Per Compartment

Two holding cabinets store hot or cold food in Gastronorm Food Pans with Covers.
 12 GN 1/1 full size 6,5 cm deep pans or
 8 GN 1/1 full size 10 cm deep pans or
 6 GN 1/1 full size 15 cm deep pans or
 4 GN 1/1 full size 20 cm deep pans.
 4 each 2025 Camtrays or
 8 each 3253 Camtrays.

CODE	DESCRIPTION	DIMENSIONS L x W x H	CASE PACK
Optional Accessories			
CB1220	Cutting board	53,5 x 33,5 x 1,3 cm	1
CP814	20,32 x 35,56 cm Camchiller	3,81 x 20,32 x 35,56	1
CP3253	Camchiller®	53 x 32,5 x 3	1
WCR1220	Well cover	53,5 x 33 x 5	1
1600DIV	ThermoBarrier® insulated shelf	53 x 33,5 x 3,8	2

CAMKIOSK® HAND SINK CART, WORK STATION & EQUIPMENT STAND

Hand Sink Cart

- Self-contained, electric hand washing system can be used alone or with CamKiosk Cart.
- Run hot and cold water for up to 70 hand washings.
- Includes: double sink, two 19 L fresh water tanks, two 28,5 L waste-water bins, hand soap dispenser and paper towel roll holder.
- Durable polyethylene will not crack, dent, bubble, chip or break.
- Hand Sink Cart is designed for hand washing. It contains no filter for purifying water for drinking.
- Faucet is compliant with lead-free regulations.

Colors: Granite Grey (191), Granite Green (192), Navy Blue (186), Hot Red (158), Kentucky Green (519), Black Base with Granite Grey Top & Doors (426).

15,2 cm Casters: 2 fixed, 2 swivel, 2 with brake.

Hand Sink Cart is covered by U.S. Patent 6,173,458 B1.



Water heater and water pump draw a maximum of 11,25 amps and 0,7 amps, respectively. Hand Sink Cart electrical system runs on an average 10 amps.

ADA faucet available. Contact Cambro Customer Service for information.

Hand Sink Cart is designed for hand washing. It contains no filter for purifying water for drinking.



CODE	VOLTAGE	DIMENSIONS L x W x H
KSC402	110V	103 x 84 x 116 cm

Case Pack: 1

Work Station

- Use to merchandise menu items, additional work space or to complete sales transactions.
- Large dry storage cabinet below is perfect for holding supplies.
- Extremely durable all-weather polyethylene will not crack, dent, bubble, chip, rust or break.

Colors: Granite Grey (191), Granite Green (192), Navy Blue (186), Hot Red (158), Kentucky Green (519), Black Base with Granite Grey Top & Doors (426).

15,2 cm Casters: 2 fixed, 2 swivel, 2 with brake.

Top work area dimensions: 57,2 x 66 cm



Shown with optional cutting board and paper towel roll dispenser.



CODE	DESCRIPTION	DIMENSIONS L x W x H
KWS40	Work station	103 x 84 x 116 cm
CB1220	Cutting board	53,5 x 33,5 x 1,3

Case Pack: 1

Equipment Stand

- Perfect for self-serve stations, prep areas or cash register service.
- Counter and side openings for electrical cords and cables.
- Durable, lightweight polyethylene will not crack, dent, bubble, chip, rust or break.
- No assembly required.

Color: Black (110).

12,7 Casters: 2 fixed, 2 swivel with brake.

*Special order item not carried in stock – non-returnable.







Cutaway chair area gives ample space for comfortable seating.

CODE	DESCRIPTION	OVERALL DIM. W x D x H**
ES28	Stand only	71 x 71 x 99 cm
ES28RL*	Stand w/rails on right and left sides of drawer	112 x 71 x 99

**Width includes tray rails. Height includes casters.

CAMCRUISER® VENDING CARTS

- Add revenue opportunities away from the kitchen or cafeteria and reduce wait times.
- Durable polyethylene will not crack, dent, bubble, chip, rust or break.
- Display panel can be personalized with a custom logo or message.
- Larger models CVC724 & CVC72 have insulated food storage compartments and full-size food pan wells.
- Compact model CVC55 has two open storage compartments, a single food pan well, cutting board and umbrella.

Cart Colors	Umbrella Colors
Black (110)	
Hot Red (158)	
Kentucky Green (519)	
Granite Gray (191)	
Granite Green (192)	



CVC724

OPEN COMPARTMENT DIMENSIONS:
W 33,5 x D 61,5 x H 34 cm



CVC72

CVC72 & CVC724



CVC724 Four full size food pan wells. Replace with cutting boards or well covers to create additional work space.



CVC72 One full size food pan well and 2 larger merchandising wells.



Open holding compartment conveniently stores cash box and tray.

CODE	CVC724	CVC72	CVC55
OVERALL DIMENSION* L x W x H	189 x 81 x 239 cm	189 x 81 x 239 cm	140 x 80 x 238 cm
WORK COUNTER HEIGHT	93 cm	93 cm	101 cm
COUNTER WELLS HOLD	4 GN 1/1	Center well, 1 GN 1/1 2 outer wells, L 56 x W 39 x D 15 cm	1 GN 1/1
CLOSED COMPARTMENT CAPACITY (EACH)	2 GN 1/1-20 cm + 2 GN 1/1-6,5 cm deep pans or 4 GN 1/1-15 cm deep pans or 6 GN 1/1-10 cm deep pans or 8 GN 1/1-6,5 cm deep pans or 4 each 2025 Camtrays or 8 each 3253 Camtrays	2 full size 20 cm + 2 GN 1/1-6,5 cm deep pans or 4 GN 1/1-15 cm deep pans or 6 GN 1/1-10 cm deep pans or 8 GN 1/1-6,5 cm deep pans or 4 each 2025 Camtrays or 8 each 3253 Camtrays	—
OPEN COMPARTMENT CAPACITY	1 cash drawer and 1 GN 1/1-15 cm deep pan or 2 GN 1/1-10 cm deep pans or 3 GN 1/1-6,5 cm deep pans	1 cash drawer and 1 GN 1/1-15 cm deep pan or 2 GN 1/1-10 cm deep pans or 3 GN 1/1-6,5 cm deep pans	—
UMBRELLA DIAMETER	183 cm	183 cm	152 cm
CASTERS	20,3 cm - 4 swivel with brake	20,3 cm - 4 swivel with brake	15,2 cm - 2 fixed, 2 swivel with brake
CASH DRAWER	Yes	Yes	—
MENU BOARD	Yes	Yes	—
DISPLAY PANEL	Yes	Yes	Yes
MOLDED IN HANDLES	2	2	1

*Includes Umbrella. Serving counter height is 130 cm.

CAMCRUISER® VENDING CARTS



CVC55

Unit ships with umbrella and cutting board.
Front display panel can be personalized.



Pizza Camcruiser



Sandwich Camcruiser



Hot Dog Camcruiser



Soft Drink Camcruiser

Display Panel Personalization

Provide complete, finished, camera-ready artwork and indicate positioning on display panel.

Ink colors must be specified.
Choose 1-4 colors.

Size of imprinting area:

CVC72 and CVC724

W 53,5 x H 74,5 cm

CVC55 W 112,5 x H 74,5 cm.

Artist's fee of **net/hour will be charged to any order submitted without camera-ready artwork.

Cambro will contact you prior to completing any work if this fee will be charged.

Set up charge of **net per design, plus **net per color.

Allow for three week production lead time once final proofs are approved.

CVC72 and CVC724 - Campus Cuisine display panel standard with all orders unless custom personalization requested.

**Contact your Cambro representative for pricing.

Cutting Board Color: White (148).

Camchiller Color: Glacier Blue (443).

Divider Bar Colors: White (148),

Clear (135).

Retainer Strap Color: Black (110).

ThermoBarrier® Color: Slate Blue (401).

Well Cover Color matches cart.

CVC55 is covered by U.S. Patent

D 362,102.



Camchiller,
ThermoBarrier,
and Divider Bar.



Compartments are open for storage and easy access to equipment and supplies for your vending operations. Optional retainer strap is sold separately.

LEFT COMPARTMENT DIMENSIONS:

W 61,5 x D 72,5 x H 70 cm

RIGHT COMPARTMENT DIMENSIONS:

W 54,5 x D 72,5 x H 70 cm

CVC55



Set up with full and fractional size food pans and divider bars to increase product offerings.



Electrical or soda line conveniently drops through 10 x 17 cm opening in counter. Cover is standard with cart.

CODE	DESCRIPTION	FITS	OVERALL DIM. L x W x H
Optional Accessories			
CB1220	Cutting board	CVC724, CVC72, CVC55	53,5 x 33,5 x 1,3 cm
CP3253	Camchiller®	CVC724, CVC72	53 x 32,5 x 3
DIV12	Divider bar	CVC724, CVC72, CVC55	32,5 long
WCR1220	Well cover	CVC724, CVC72, CVC55	53,5 x 33 x 5
730STP	Retainer strap	CVC55	—

DIV12 Case Pack: 3 **730STP Case Pack:** 2 **All Others Case Pack:** 1
Camchiller, ThermoBarrier & Divider Bar are NSF listed.

CAMSHELVING PREMIUM® SERIES FLEX STATION SYSTEM

Grab-N-Go solution for K-12 schools



Promote healthy eating habits

CPM244867FX1

Setup anywhere in school

Reduces serving time

CAMSHELVING PREMIUM® SERIES FLEX STATION SYSTEM

Ideal for takeout, delivery or curbside staging needs

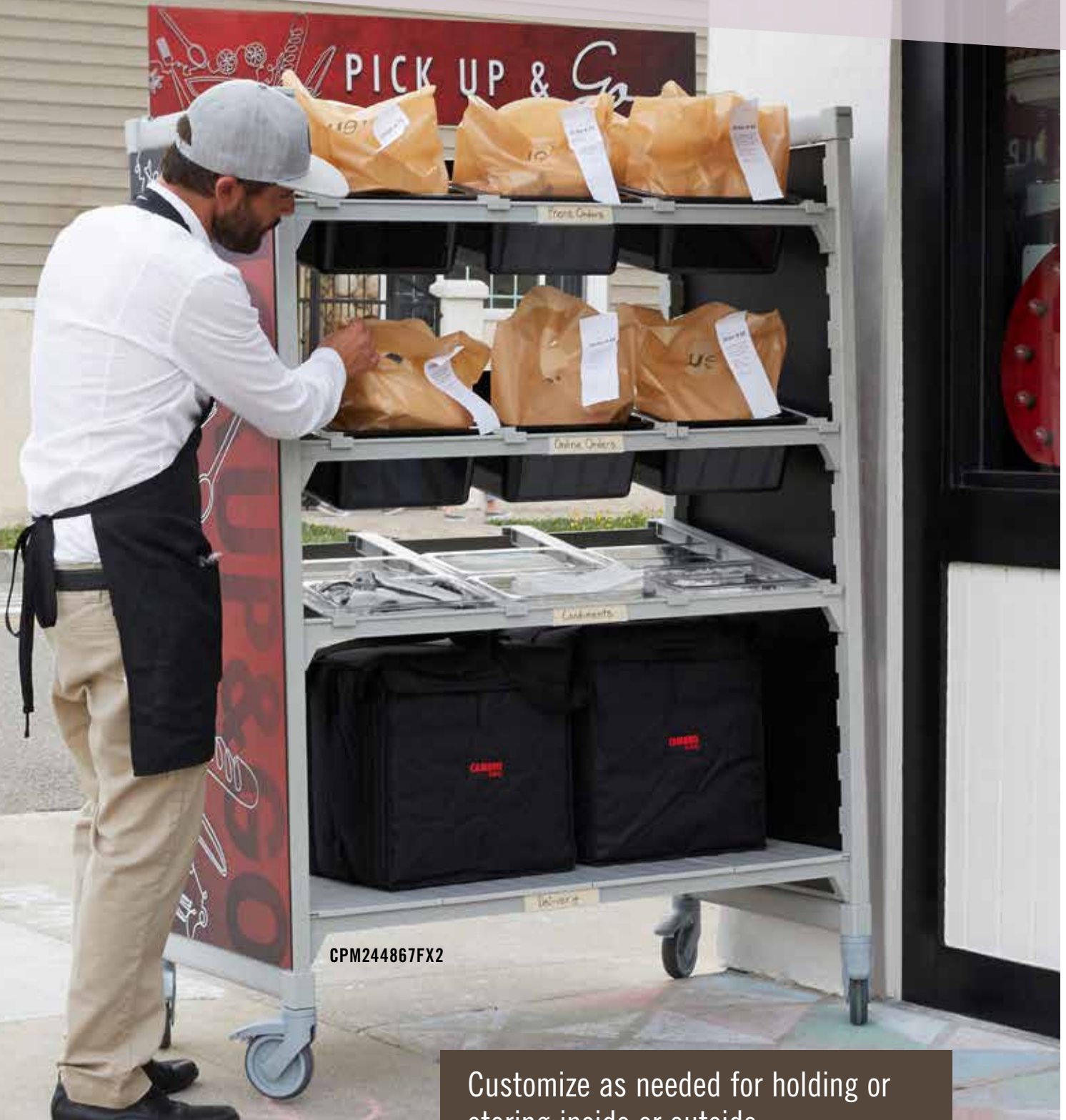

CPM244867FX2

Customize as needed for holding or
storing inside or outside

CAMSHELVING PREMIUM® SERIES FLEX STATIONS



CPM244867FX3 (1700 mm H)
CPM244875FX4 (1910 mm H)



CPM244875FX5

MERCHANDISERS



CODE	DESCRIPTION	DIMENSIONS D x L x H
Premium® Series Flex Stations		
CPM244867FX1	4 Tiers with Angled Divider Bars	610 x 1220 x 1700 mm
CPM244867FX2	1 Solid Shelf, 3 Tiers with Angled Divider Bars	610 x 1220 x 1700
CPM244867FX3	4 Solid Shelves with Divider Panels	610 x 1220 x 1700
CPM244875FX4	4 Solid Shelves with Divider Panels	610 x 1220 x 1910
CPM244875FX5	2 Solid Shelves, 3 Tiers with Angled Divider Bars	610 x 1220 x 1910
Merchandiser Kits		W x H
CSFLEXMERCH	Fast & Fresh Full Kit – 2 side panels, 1 top panel	58,42 x 142,24 cm Side 122 x 20,32 cm Header
CSFLEXMERCH2	Pickup & Go Full Kit – 2 side panels, 1 top panel	58,42 x 142,24 cm Side 122 x 20,32 cm Header
CSFLEXMERCH3	Fast & Fresh Top Panel Kit	122 x 20,32 cm
CSFLEXMERCH4	Pickup & Go Top Panel Kit	122 x 20,32 cm

Case Pack: 1 Premium Flex Station Color: Speckled Gray (480). Made in USA only.



VERSA ORGANIZERS

- Use to store non-perishable condiments, disposable ware and napkins.
- Hold bins in 2 x 3, 2 x 4, 3 x 3, or 3 x 4 arrangements.
- Made of seamless, one-piece polyethylene.
- Set on flat surface or wall mount each bin holds up to 4,5 kg.
- Easy to assemble and easy to clean.

Bins only colors: Dark Brown (131), Black (110), Slate Blue (401), Speckled Grey (480).

Versa line combined pack bins & racks.

Colors: Black (110), Speckled Grey (480).



STOCK PRODUCTS & COLORS AVAILABLE IN OUR EUROPEAN WAREHOUSE

5412CBP: (131), (480)
6RS6: (480)



12RS12 Versa Organizer shown mounted on wall.



Bins sold separately (5412CBP) or as combined packs.



12RS12



9RS9



8RS8



6RS6

CODE	DESCRIPTION	PRODUCT DIMENSIONS	CASE PACK
		W x D x H	
5412CBP	Bin only	13 x 30,5 x 11 cm	12
Versa Line Combined Pack		L x D x H (complete unit)	
12RS12	Rack w/12 bins	64,8 x 54,3 x 36,2	1
9RS9	Rack w/9 bins	51,1 x 54,3 x 36,2	1
8RS8	Rack w/8 bins	64,8 x 48,8 x 24,1	1
6RS6	Rack w/6 bins	51,1 x 48,8 x 24,1	1

PORTABLE CAMBARS®

A BAR FOR ALL OCCASIONS.

Portable and versatile, the CamBar makes outfitting events an opportunity rather than a hassle. CamBars deliver function and style whether you're pouring a drink from a bottle or creating a wide-variety of on-demand beverages.



BUILD YOUR CAMBAR®

SIZE Cambars® come in three sizes



SMALL | DIMENSIONS
Length: 137,2 cm
Width: 65,7 cm
Height: 117,2 cm



MEDIUM | DIMENSIONS
Length: 171,5 cm
Width: 72,4 cm
Height: 120,7 cm



LARGE | DIMENSIONS
Length: 184,8 cm
Width: 66 cm
Height: 121,2 cm

DESIGN Select from a variety of colors and decors [Click to enlarge the images](#) 

STANDARD DECOR



DESIGNER DECOR





BAR540

Highly portable, compact beverage bar for limited space.



FEATURES

- 5-bottle speed rail
- Four 12,7 cm swivel casters, 2 with brake
- Vinyl cover

AVAILABLE IN THESE COLORS



Black
110



Dark Brown
131



Slate Blue
401



Granite Gray
191



Granite Sand
194



Charcoal Gray
615

Click to enlarge the images

OPTIONAL ACCESSORIES

BAR54SR

730SR

5 Bottle Speed Rail
for BAR540 and
BAR540DS

7 Bottle Speed Rail
for BAR540DS

BAR540

BAR540DS

DECOR	Standard	Designer
ICE SINK AND COVER	Sink only	Sink only
VINYL COVER	Yes	Yes
UNIT WEIGHT	55,6 kg.	65,8 kg.

All BAR540 models include four 12,7 cm swivel casters, two with brake.



BAR650

Mid-size beverage bar that fits standard elevators, ideal for off-premises catering.



FEATURES

- 7-bottle speed rail
- 36,3 kg capacity ice sink
- Vinyl cover
- Ice sink and cover
- Waste-water bin
- Retainer Strap

AVAILABLE IN THESE COLORS



Black
110



Granite Gray with Black Base
420



Chicago
770



Carmel
669

Click to enlarge the images 

BAR650

BAR650DS

DECOR	Standard	Designer
ICE SINK AND COVER	Yes	Yes
RETAINER STRAP	1	1
WASTE WATER BIN	Yes	Yes
VINYL COVER	Yes	Yes
UNIT WEIGHT	98 kg.	98,5 kg.

All BAR650 models include four 12,7 cm swivel casters, two with brake.

OPTIONAL ACCESSORIES

650WS	730SR
Wire Shelf	7 Bottle Speed Rail



BAR730

Spacious rolling bar for banquets and large events.



FEATURES

- 7-bottle speed rail
- 36,3 kg capacity ice sink
- 6 & 8-button soda gun
- Vinyl cover
- Ice sink and cover
- Waste-water bin
- Retainer Strap

AVAILABLE IN THESE COLORS



Click to enlarge the images

BAR730 BAR730DS

DECOR	Standard	Designer
ICE SINK AND COVER	Yes	Yes
RETAINER STRAP	2	2
WASTE WATER BIN	Yes	Yes
VINYL COVER	Yes	Yes
UNIT WEIGHT	103,8 kg.	133,9 kg.

All BAR650 and BAR730 models include four 15,24 cm swivel casters, two with brake.

OPTIONAL ACCESSORIES

730SR	730WS
7 Bottle Speed Rail	Wire shelf

SLIDINGLID™ ICE CADDIES

- Polyethylene body and thick foam insulation hold ice for days.
- Rugged, all-weather exterior will not crack, dent, bubble, chip, rust or break.
- Unique sliding lid slides back and under during use, reducing risk of cross-contamination.
- Recessed well and drain shelf keep ice out of water, extending holding times.
- Recessed, molded-in handles ease lifting and maneuvering.
- Slant top sliding lid units fit under prep/catering tables and counters.

Colors: Black (110), Slate Blue (401), Dark Brown (131), Coffee Beige (157), Granite Grey (191).

SlidingLid Ice Caddies ICS125L, ICS125L4S, ICS125LB are covered by US Patent D 468,071 S. SlidingLid Ice Caddies ICS100L and ICS100L4S are covered by US Patent D 424,883.



STOCK PRODUCTS & COLOR AVAILABLE IN OUR EUROPEAN WAREHOUSE

ICS100L, ICS125L: (191)

Caster Descriptions

Refers to caster type in chart.
All casters are 12,7 cm.

A: 2 fixed, 2 swivel, 1 with brake

A1: 2 swivel, 2 with brakes

B: 4 swivel, 1 with brake

C: 2 swivel, 1 with brake,
2 20,3 cm Easy Wheels

D: 2 swivel, 1 with brake,
2 25,4 cm Easy Wheels

E: 2 swivel, 1 with brake,
2 25,4 cm Wide Easy Wheels



ICS175LB
(Short) Shown with
Rear Easy Wheels.



ICS125L
(Short)



ICS100L
(Short)



ICS175T
(Tall)



ICS175TB
(Tall) Shown with Rear Easy Wheels.



ICS200TB
(Tall) Shown with Rear Wide Easy Wheels.



CODE	CAPACITY	EXTERIOR DIMENSIONS W x D x H	CASTER TYPE
Short			
ICS100L	46 kg	57 x 77 x 73 cm	A1
ICS100L4S	46	57 x 77 x 73	B
ICS125L	57	58,5 x 80 x 74,5	A
ICS125LB	57	58,5 x 80 x 74,5	C
ICS175L	80	61 x 95,5 x 74,5	A
ICS175LB	80	61 x 95,5 x 74,5	D
Tall			
ICS125T	57	58,5 x 80 x 88	A
ICS175T	80	58,5 x 86,5 x 95,5	A
ICS175TB	80	58,5 x 86,5 x 95,5	D
ICS200TB	91	58,5 x 86,5 x 100,5	E

Case Pack: 1

CAMRACK® 4-IN-1 WAREWASHING SYSTEM

The Camrack System will protect glassware and keep it clean until the next event, eliminating the need for rewashing.

Efficient Washing

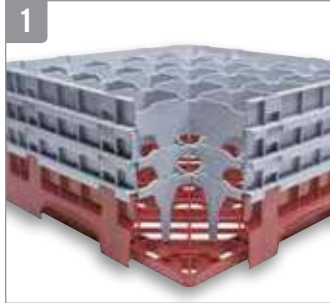

Open inside compartments provide thorough circulation of water and cleaning solutions and promote quick and thorough drying.

Long-lasting polypropylene Camracks are built to withstand chemicals and high temperatures up to 93°C.

Sanitary Storage



Closed outer walls keep fingers and contaminants out and reduce risk of breakage and injury. The Camrack cover and Camdolly make this system completely enclosed. Glassware stays clean in storage, eliminating rewashing.

Inventory Control



A variety in base rack colors help identify at a glance both contents and quantity per rack. Available in 10 colors.

Safe, Sanitary Transportation



Camracks can be transported across large campuses or to off-site locations in one single unit.

Easy to grip handles and smooth overlapping sides facilitate safe handling.

Camrack Cover Seals from the Top and Camdolly® Seals from the Bottom.



Camracks interstack with racks from major manufacturers.



Content labeling options include one-color custom hot stamping or pre-printed clips.



Camracks are covered by one or more of the following patents: Full Base Dish Rack D 412,607. Half Base Dish Rack D 404,176. Half Dish Rack Extender D 400,321. Enlarged Dish Rack Extender D 399,614. Dish Rack with Extender 5,934,486 Utility Patent. Pronged Base Dish Rack D 403,472.

FULL SIZE CAMRACKS® FOR STEMWARE & TUMBLERS

These racks offer complete protection for all your delicate and valuable stemware and tumblers, from washing and handling to stacking, storing and transporting.

Choose the correct dishrack:

1. Measure the maximum diameter of your glass (stemware or tumbler) to determine the number of compartments.
2. Measure the maximum height of your glass (stemware or tumbler) to the top edge of the rim to determine the compartment height.

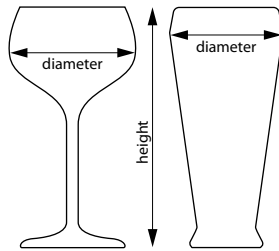

25S534

STOCK PRODUCTS & COLORS AVAILABLE IN OUR EUROPEAN WAREHOUSE

ALL CAMRACKS: (110), (119), (151), (163), (167), (168), (184), (186), (414), (416)

14,9 cm
MAXIMUM DIAMETER

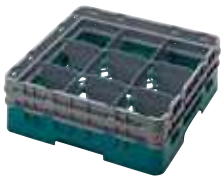

9 COMPARTMENT

	MAXIMUM HEIGHT	9,2 cm	13,3 cm	17,4 cm	21,5 cm	25,7 cm	29,8 cm
CODE		9S318	9S434	9S638	9S800	9S958	9S1114
CASE PACK		5	4	3	2	2	2
EXT. RACK HEIGHT		14,3 cm	18,4 cm	22,5 cm	26,7 cm	30,8 cm	34,9 cm

11,11 cm
MAXIMUM DIAMETER



16 COMPARTMENT

	MAXIMUM HEIGHT	9,2 cm	11,4 cm	13,3 cm	15,5 cm	17,4 cm	19,6 cm
CODE		16S318	16S418**	16S434	16S534**	16S638	16S738**
CASE PACK		5	5	4	4	3	3
EXT. RACK HEIGHT		14,3 cm	14,3 cm	18,4 cm	18,4 cm	22,5 cm	22,5 cm
	MAXIMUM HEIGHT	21,5 cm	23,8 cm	25,7 cm	27,9 cm	29,8 cm	32 cm
CODE		16S800	16S900**	16S958	16S1058**	16S1114	16S1214**
CASE PACK		2	2	2	2	2	2
EXT. RACK HEIGHT		26,7 cm	26,7 cm	30,8 cm	30,8 cm	34,9 cm	34,9 cm

Base Rack Colors:

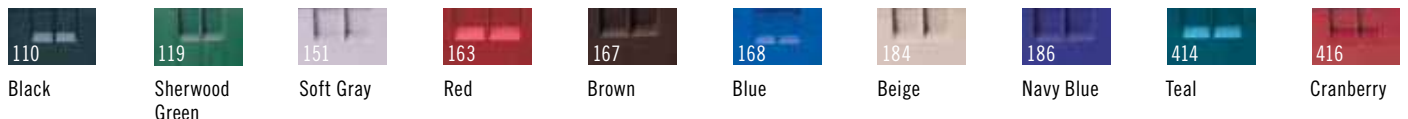

Extender Color: Soft Grey (151). **Compartment Extenders cannot be added. Personalization available. See Camrack personalization and color coding page. For a more accurate color representation, call your sales rep for actual color chips. Contact Customer Service for all special orders.

FULL SIZE CAMRACKS® FOR STEMWARE & TUMBLERS

9,84 cm
MAXIMUM DIAMETER



20 COMPARTMENT

	MAXIMUM HEIGHT	9,2 cm	11,4 cm	13,3 cm	15,5 cm	17,4 cm	19,6 cm
CODE		20S318	20S418**	20S434	20S534**	20S638	20S738**
CASE PACK		5	5	4	4	3	3
EXT. RACK HEIGHT		14,3 cm	14,3 cm	18,4 cm	18,4 cm	22,5 cm	22,5 cm
	MAXIMUM HEIGHT	21,5 cm	23,8 cm	25,7 cm	27,9 cm	29,8 cm	32 cm
CODE		20S800	20S900**	20S958	20S1058**	20S1114	20S1214**
CASE PACK		2	2	2	2	2	2
EXT. RACK HEIGHT		26,7 cm	26,7 cm	30,8 cm	30,8 cm	34,9 cm	34,9 cm

**Compartment Extenders cannot be added.

8,7 cm
MAXIMUM DIAMETER



25 COMPARTMENT

	MAXIMUM HEIGHT	9,2 cm	11,4 cm	13,3 cm	15,5 cm	17,4 cm	19,6 cm
CODE		25S318	25S418**	25S434	25S534**	25S638	25S738**
CASE PACK		5	5	4	4	3	3
EXT. RACK HEIGHT		14,3 cm	14,3 cm	18,4 cm	18,4 cm	22,5 cm	22,5 cm
	MAXIMUM HEIGHT	21,5 cm	23,8 cm	25,7 cm	27,9 cm	29,8 cm	32 cm
CODE		25S800	25S900**	25S958	25S1058**	25S1114	25S1214**
CASE PACK		2	2	2	2	2	2
EXT. RACK HEIGHT		26,7 cm	26,7 cm	30,8 cm	30,8 cm	34,9 cm	34,9 cm

**Compartment Extenders cannot be added.

7,94 cm
MAXIMUM DIAMETER



30 COMPARTMENT

	MAXIMUM HEIGHT	9,2 cm	13,3 cm	17,4 cm	21,5 cm	25,7 cm	29,8 cm
CODE		30S318	30S434	30S638	30S800	30S958	30S1114
CASE PACK		5	4	3	2	2	2
EXT. RACK HEIGHT		14,3 cm	18,4 cm	22,5 cm	26,7 cm	30,8 cm	34,9 cm

**STOCK PRODUCTS & COLORS
AVAILABLE IN OUR EUROPEAN
WAREHOUSE**

ALL CAMRACKS: (110), (119), (151), (163), (167), (168), (184), (186), (414), (416)

FULL SIZE CAMRACKS® FOR STEMWARE & TUMBLERS

7,3 cm
MAXIMUM DIAMETER



36 COMPARTMENT

	MAXIMUM HEIGHT	9,2 cm	11,4 cm	13,3 cm	15,5 cm	17,4 cm	19,6 cm
CODE		36S318	36S418**	36S434	36S534**	36S638	36S738**
CASE PACK		5	5	4	4	3	3
EXT. RACK HEIGHT		14,3 cm	14,3 cm	18,4 cm	18,4 cm	22,5 cm	22,5 cm
	MAXIMUM HEIGHT	21,5 cm	23,8 cm	25,7 cm	27,9 cm	29,8 cm	32 cm
CODE		36S800	36S900**	36S958	36S1058**	36S1114	36S1214**
CASE PACK		2	2	2	2	2	2
EXT. RACK HEIGHT		26,7 cm	26,7 cm	30,8 cm	30,8 cm	34,9 cm	34,9 cm

6,2 cm
MAXIMUM DIAMETER



49 COMPARTMENT

	MAXIMUM HEIGHT	9,2 cm	13,3 cm	17,4 cm	21,5 cm	25,7 cm	29,8 cm
CODE		49S318	49S434	49S638	49S800	49S958	49S1114
CASE PACK		5	4	3	2	2	2
EXT. RACK HEIGHT		14,3 cm	18,4 cm	22,5 cm	26,7 cm	30,8 cm	34,9 cm

STOCK PRODUCTS & COLORS AVAILABLE IN OUR EUROPEAN WAREHOUSE

ALL CAMRACKS: (110), (119), (151), (163), (167), (168), (184), (186), (414), (416)



Base Rack Colors:

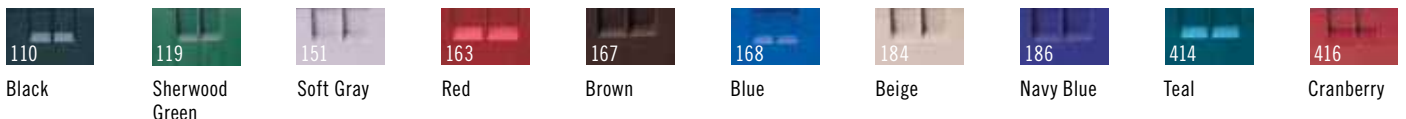

Extender Color: Soft Grey (151). **Compartment Extenders cannot be added. Personalization available. See Camrack personalization and color coding page. For a more accurate color representation, call your sales rep for actual color chips. Contact Customer Service for all special orders.

HALF SIZE CAMRACKS® FOR STEMWARE & TUMBLERS

- Very effective for carrying less weight and for storing drinkware in space-restricted locations.
- Ideal for small under-counter glasswashers.

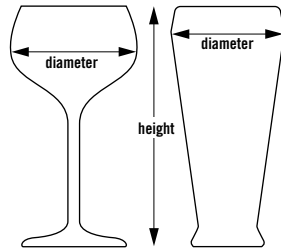

10HS434

10,3 cm
MAXIMUM DIAMETER



8 COMPARTMENT

	MAXIMUM HEIGHT	9,2 cm	13,3 cm	17,4 cm	21,5 cm	25,7 cm	29,8 cm
CODE		8HS318	8HS434	8HS638	8HS800	8HS958	8HS1114
CASE PACK		5	4	3	2	2	2
EXT. RACK HEIGHT		14,3 cm	18,4 cm	22,5 cm	26,7 cm	30,8 cm	34,9 cm

8,7 cm
MAXIMUM DIAMETER



10 COMPARTMENT

	MAXIMUM HEIGHT	9,2 cm	13,3 cm	17,4 cm	21,5 cm	25,7 cm	29,8 cm
CODE		10HS318	10HS434	10HS638	10HS800	10HS958	10HS1114
CASE PACK		5	4	3	2	2	2
EXT. RACK HEIGHT		14,3 cm	18,4 cm	22,5 cm	26,7 cm	30,8 cm	34,9 cm

7,3 cm
MAXIMUM DIAMETER



17 COMPARTMENT

	MAXIMUM HEIGHT	9,2 cm	13,3 cm	17,4 cm	21,5 cm	25,7 cm	29,8 cm
CODE		17HS318	17HS434	17HS638	17HS800	17HS958	17HS1114
CASE PACK		5	4	3	2	2	2
EXT. RACK HEIGHT		14,3 cm	18,4 cm	22,5 cm	26,7 cm	30,8 cm	34,9 cm

Base Rack Colors:



Sherwood Green



Soft Grey

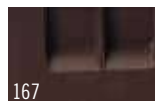

Brown



Beige



Navy Blue



Cranberry

Extender Color: Soft Grey (151). Personalization available. See Camrack personalization and color coding page. For a more accurate color representation, call your sales rep for actual color chips. Contact Customer Service for all special orders.

CAMRACK® FULL & HALF SIZE CUP RACKS

- Tilt feature drains water from mug or cup bases for quick and sanitary drying.

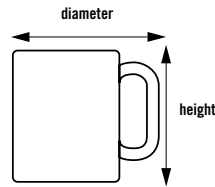

11,1 x 10,95 cm

COMPARTMENT DIMENSIONS



16 COMPARTMENT

	MAXIMUM HEIGHT	6,6 cm	10,7 cm	14,9 cm
CODE		16C258	16C414	16C578
CASE PACK		6	5	4
EXT. RACK HEIGHT		10,1 cm	14,3 cm	18,4 cm

STOCK PRODUCTS & COLORS AVAILABLE IN OUR EUROPEAN WAREHOUSE

16C258, 16C414, 16C578, 20C258, 20C414: (151)

11,1 x 8,73 cm

COMPARTMENT DIMENSIONS



20 COMPARTMENT

	MAXIMUM HEIGHT	6,6 cm	10,7 cm
CODE		20C258	20C414
CASE PACK		6	5
EXT. RACK HEIGHT		10,1 cm	14,3 cm



10,4 x 11,1 cm

COMPARTMENT DIMENSIONS



8 COMPARTMENT

	MAXIMUM HEIGHT	6,6 cm	10,7 cm
CODE		8HC258	8HC414
CASE PACK		6	5
EXT. RACK HEIGHT		10,1 cm	14,3 cm

Glass and Cup Keepers

Color: Beige (133).



- Raised ribs for easy draining and drying.

- Holds 20 glasses or 12 cups per layer.

10,4 x 8,73 cm

COMPARTMENT DIMENSIONS



10 COMPARTMENT

	MAXIMUM HEIGHT	6,6 cm	10,7 cm
CODE		10HC258	10HC414
CASE PACK		6	5
EXT. RACK HEIGHT		10,1 cm	14,3 cm



Max. Glass Inside Rim Diameter: GK2000: 6,6 cm



Max. Cup Inside Rim Diameter: KK1200: 7,4 cm

Base Cup Rack Color: Soft Grey (151). Extender Color: Soft Grey (151). Personalization available. See Camrack personalization and color coding page. Contact Customer Service for all special orders.

CODE	SIZE	CASE PACK
Glass Keepers		
GK2000 (Regal)	35,6 x 45,7 cm	12
Cup Keepers		
KK1200 (Regal)	35,4 x 45,4	12

STEMWARE AND GLASS SIZING REFERENCE GUIDE

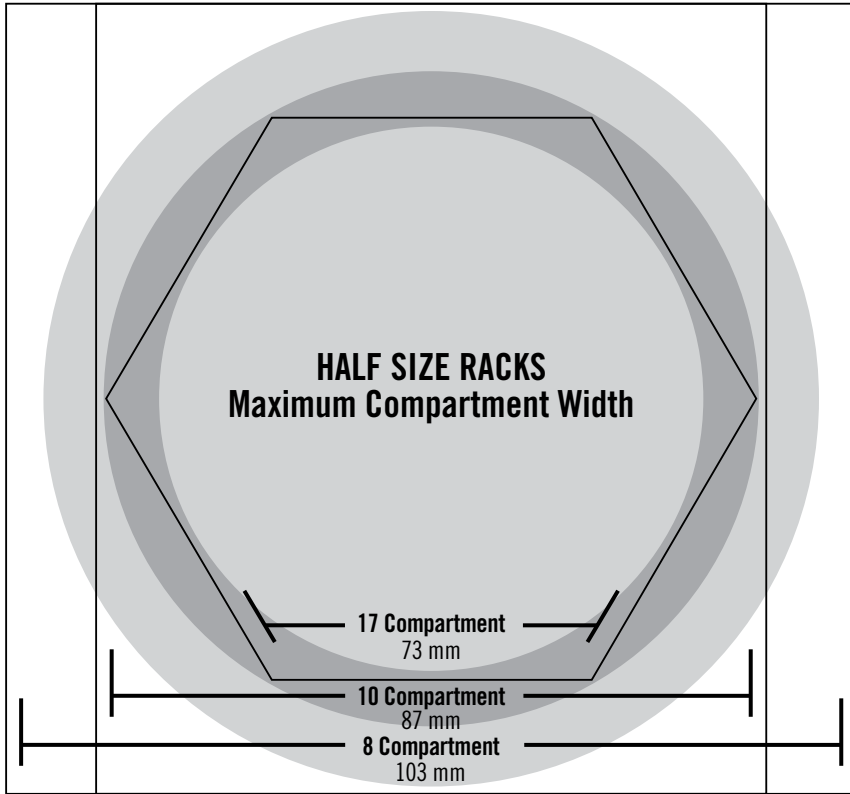

To Determine Compartment Size

• Half Size Racks:

Place glass or stemware upside down over circle chart. Look down on the glass. Whatever circle the largest diameter of the glass fits within will determine the number of compartments.

• Full Size Racks:

Place glass or stemware upside down over circle chart. Look down on the glass. Whatever circle the largest diameter of the glass fits within will determine the number of compartments.

Use the vertical guide marks at right to determine item height and appropriate rack number.

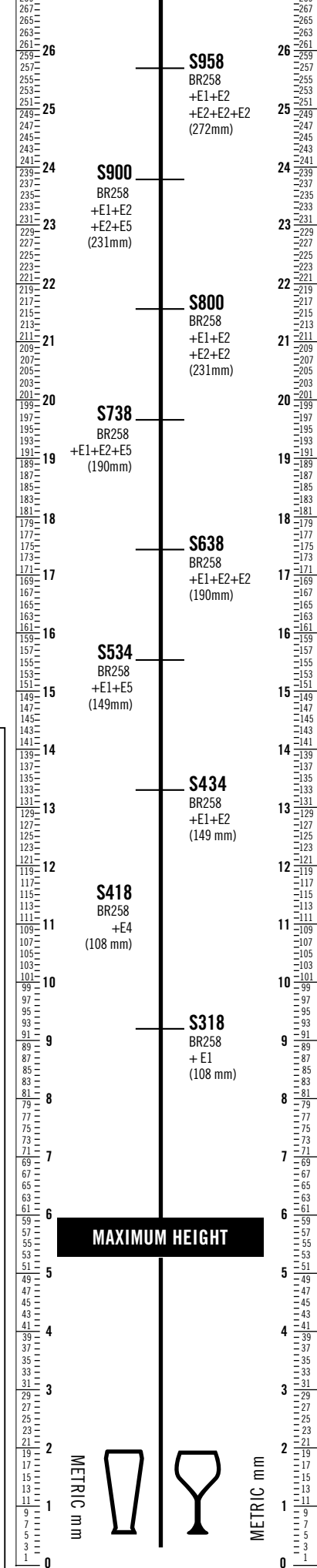
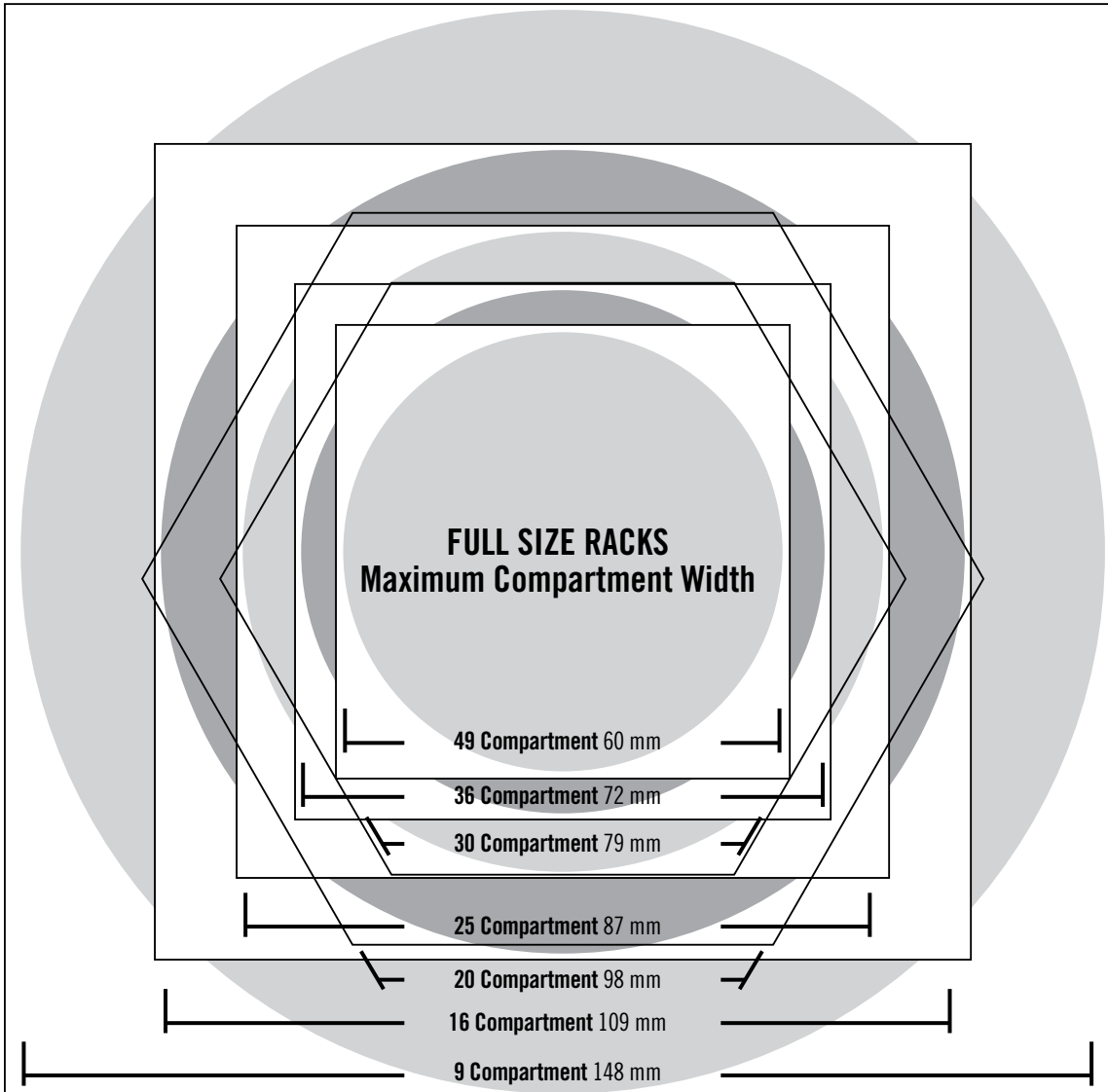

CAMRACK® CUP RACK REFERENCE GUIDE



16

FULL RACK

COMPARTMENT

11,1 x 11,1 cm

QUICK GUIDE

Full Size Cup Racks (C)

Maximum Cup Width	Number of Compartments	Maximum Cup Height		
		6,6 cm	10,7 cm	14,9 cm
11,1 cm	16	16C258	16C414	16C578
8,8 cm	20	20C258	20C414	20C578

To determine Cup compartment size:

Turn cup or coffee mug upside down and place diagonally in square. Align handle with arrow in square. Cup or mug and handle must fit completely within boundaries of a square in order to ensure the right rack.



20

FULL RACK

COMPARTMENT

11,1 x 8 cm



10

HALF RACK

COMPARTMENT

10,4 x 8,8 cm



8

HALF RACK

COMPARTMENT

11,3 x 10,4 cm

QUICK GUIDE

Full Size Cup Racks (C)

Maximum Cup Width	Number of Compartments	Maximum Cup Height	
		6,6 cm	10,7 cm
10,4 cm	8	8HC258	8HC414
8,8 cm	10	10HC258	10C414

To Determine Cup Height:

Place base of cup or coffee mug on flat surface hold ruler vertically next to it to determine height in inches or millimeters. If the height is greater than 108 mm, additional 41 mm E2 and HE2 extenders may be ordered.

STORE AND TRANSPORT GLASSES & DISHES

Camrack® Cover & Camdolly®

- Use to cover and protect full size Camrack dishracks filled with clean dishware.
- When used with a Camdolly, creates a portable sanitary storage system that protects contents between uses.
- Eliminates the use of messy, wasteful plastic wrap or vinyl covers.



FULL RACK COVER

CODE	DRC2020
EXTERIOR DIMENSIONS	50 x 50 x 2,4 cm

Case Pack: 1 Color: Grey (180).

STOCK PRODUCTS & COLORS AVAILABLE IN OUR EUROPEAN WAREHOUSE

DRC2020: (180)
CDR2020, CDR2020H: (151)



	CAMDOLLY	CAMDOLLY WITH HANDLE
CODE	CDR2020	CDR2020H
INTERIOR DIMENSIONS	53 x 53 cm	53 x 53 cm
EXTERIOR DIMENSIONS	54,5 x 54,5 x 20,5 cm	54,5 x 59,5 x 94 cm
LOAD CAPACITY	159 kg	159 kg

Case Pack: 1 Color: Soft Grey (151). Casters: 10 cm casters, 4 swivel, no brakes.

Camrack IceExpress Glass Filler

- Dramatically reduces banquet set-up time.
- Fills 25 glasses with ice all at once.

- Reduces breakage and risk of contamination.
- Ice falls directly into glasses with no spills or drips.



CODE	EXTERIOR DIM. W x D x H
25SWGf	50,8 x 50,8 x 3,18 cm

Case Pack: 1 Color: Black (110).

SELECTING THE RIGHT CAMRACK

Cambro offers multiple ways to help you quickly find the right Camrack:

1. apps.cambro.com/Camracks

Select the item you are sizing, enter the measurements and quantity of the item, and the right Camrack will appear on the page.

2. Cambro Catalog

Flip to the back of the catalog for a convenient stemware, glass and cup sizing reference guide.

3. Cambro Sales Representatives

Contact your local Cambro representative or call Cambro Customer Service at 49-7022-90-100-0 to assist with specifying Camracks, dollies and covers that will fit your glasses and dishware.

4. Cambro App

Find the right Camrack for your glassware by entering the height and maximum diameter of your glass.

Choose the correct Camrack:

1. Measure the **maximum diameter** of the glass (stemware or tumbler) to determine the number of compartments.
2. Measure the **maximum height** of the glass (stemware or tumbler) to the top edge of the rim to determine the compartment height.

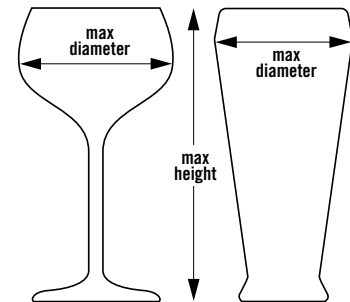

Download the app at www.cambro.com/app or



CAMRACK® BASE RACKS

- For pots, pans, bowls and large prep, service and display items.
- Half racks work well for storing items at a wait station.

STOCK PRODUCTS & COLORS AVAILABLE IN OUR EUROPEAN WAREHOUSE

BR258, BR414, BR578, BR712: (110), (119), (151), (163), (184), (167), (168), (186), (414), (416)
CRPHDG2878: (000)



BR578

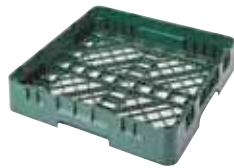

FULL SIZE BASE RACKS

	FULL BASE RACK	WITH 1 EXTENDER	WITH 2 EXTENDERS	WITH 3 EXTENDERS
CODE	BR258	BR414	BR578	BR712
INSIDE RACK HEIGHT	8,3 cm	12,4 cm	16,5 cm	20,6 cm
OUTSIDE RACK HEIGHT	10,1 cm	14,3 cm	18,4 cm	22,5 cm
CASE PACK	6	5	4	3



HALF SIZE BASE RACKS

	HALF BASE RACK	WITH 1 EXTENDER	WITH 2 EXTENDERS	WITH 3 EXTENDERS
CODE	HBR258	HBR414	HBR578	HBR712
INSIDE RACK HEIGHT	8,3 cm	12,4 cm	16,5 cm	20,6 cm
OUTSIDE RACK HEIGHT	10,1 cm	14,3 cm	18,4 cm	22,5 cm
CASE PACK	6	5	4	3

Hold Down Grid

Keeps lightweight smallwares in place during wash cycle. Use on full size Camrack base or Flatware rack.



BR414 with CRPHDG2878

FULL SIZE HOLD DOWN GRID

CODE	CRPHDG2878
Case Pack: 6	Color: Gray (000).

Base Rack Colors:

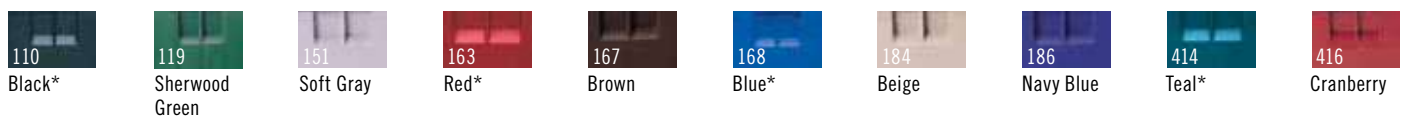

*Full size only. Extender Color: Soft Grey (151). Personalization available. See Camrack personalization and color coding page. For a more accurate color representation, call your sales rep for actual color chips. Contact Customer Service for all special orders.

CAMRACK® FULL SIZE PEG RACKS & TRAY RACK

Standard 9 x 9 Peg Rack

- Designed to wash varying sized plates, bowls, trays and plate covers.
- Standard peg racks hold:
 - Eighteen 25,4 cm plates
 - Twelve 30,5 cm plates
 - Twenty-seven 19 cm plates
- or
- Nine 36 x 46 cm trays.

Versatile 5 x 9 Peg Rack

- Holds standard plates in one direction or deep plates, bowls and plate covers in the other direction.
- 5 spacing configuration holds up to ten 25,4 cm bowls, deep plates, platters or plate covers.

- 9 spacing configuration holds up to:
 - Eighteen 25,4 cm plates
 - Twelve 30,5 cm plates
 - Twenty-seven 19 cm plates
- or
- Nine 36 x 46 cm trays.

Open End Tray Rack

- Holds cafeteria trays or full-size sheet pans.
- Open-ended on one side for easy placement and removal of trays of all lengths.
- Holds up to nine trays upright.

STOCK PRODUCTS & COLORS AVAILABLE IN OUR EUROPEAN WAREHOUSE

PR59314, PR59500, PR314, OETR314: (151)



	9 X 9 PEG RACK	9 X 9 PEG RACK WITH 1 EXTENDER	5 X 9 PEG RACK	5 X 9 PEG RACK WITH 1 EXTENDER	OPEN END TRAY RACK
CODE	PR314	PR500	PR59314	PR59500	OETR314*
INSIDE RACK HEIGHT	8,3 cm	12,4 cm	8,3 cm	12,4 cm	8,3 cm
OUTSIDE RACK HEIGHT	10,1 cm	14,3 cm	10,1 cm	14,3 cm	10,1 cm
CASE PACK	6	5	6	5	6

Color: Soft Gray (151). Extender Color: Soft Gray (151). InStock Color: Soft Gray (151). Personalization available. See Camrack personalization and color coding page. Contact Customer Service for all special orders. *Extenders may be added to all Peg Racks except the OETR314.

CAMRACK FULL & HALF SIZE FLATWARE RACKS & CYLINDER

- 8 Compartment Basket fits into a Full or Half Size Base Rack. Wire handles slide down for easy storage.

- Flatware Cylinder fits into 9-Compartment Full Size Camrack and the Cambro Tray and Dish Cart, model TDCR12.

STOCK PRODUCTS & COLORS AVAILABLE IN OUR EUROPEAN WAREHOUSE

FR258, 8FB434, 8FBNH434: (151)



	FULL FLATWARE RACK	HALF FLATWARE RACK	8 COMPARTMENT HALF FLATWARE BASKET	8 COMPARTMENT HALF FLATWARE BASKET	FLATWARE CYLINDER
CODE	FR258	HFR258	8FB434* With Handles	8FBNH434* No Handles	FWC56
INSIDE RACK HEIGHT	6,7 cm	6,7 cm	12 cm	12 cm	Wide 11,4 cm
OUTSIDE RACK HEIGHT	10,1 cm	10,1 cm	18,4 cm	18,4 cm	High 14 cm
CASE PACK	6	6	6	6	12

Color: Soft Gray (151). Extender Color: Soft Gray (151). InStock Color: Soft Gray (151). Flatware Cylinder Color: White (148). Personalization available. See Camrack personalization and color coding page. Contact Customer Service for all special orders. *Extenders cannot be added.

THE CAMRACK® COMPONENT SYSTEM

The Camrack System offers several choices for ordering the right Camracks now and as your needs change. Please consult with your sales representative or Cambro Customer Service for all special ordering and assembly directions.

Choose Between:

1. A complete selection of pre-assembled, ready to use Camracks listed in our catalog; or
2. Custom built special order Camracks for specific needs; or
3. Individual Camrack components for distributors to stock and build racks as needed.

Base Rack Colors:

Sherwood Green (119), Soft Grey (151), Brown (167), Beige (184), Navy Blue (186), Cranberry (416), Black (110)*, Red (163)*, Blue (168)*, Teal (414)*.

Base Cup Rack Color: Soft Grey (151).

Flatware Rack Color: Soft Gray (151).

Extender Color: Soft Grey (151).

Personalization available.

Full Base Racks are covered by U.S. Patent D 412,607.

Half Base Racks are covered by U.S. Patent D 404,176.

*Full size only.

STOCK PRODUCTS & COLORS AVAILABLE IN OUR EUROPEAN WAREHOUSE

9E1, 9E2, 16E1, 16E2, 16E4, 16E5, 20E2, 20GE1, 20GE2, 20GE4, 20GE5, 25E1, 25E2, 25E4, 25E5, 30GE1, 30GE2, 36E1, 36E2, 36E4, 36E5, 49E1, 49E2, 16C258, 20C258: (151)
 BR258: (110), (119), (151), (163), (184), (167), (168), (186), (414), (416)
 E3: (151)

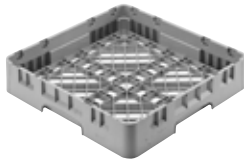

BR = Full Size Base Rack



HBR = Half Size Base Rack



E1 = Full Size Full Drop Compartment Extender



HE1 = Half Size Full Drop Compartment Extender



E2 = Full Size Half Drop Compartment Extender



HE2 = Half Size Half Drop Compartment Extender

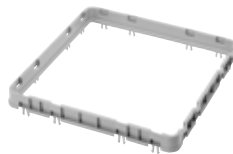

E3 = Full Size Open Extender



HE3 = Half Size Open Extender



E4 = Full Size Full Drop Compartment Extender



E5 = Full Size Half Drop Compartment Extender

Only E3 extenders may be added to E4's and E5's.

Camracks Components

CODE	DESCRIPTION	EXTERIOR DIMENSIONS	COMPARTMENT	INSIDE RACK HEIGHT	CASE PACK
Full Size Base Racks					
BR258*	Full Base Rack	500 x 500 x 101 mm	457 x 457 mm	67 mm	6
Half Size Base Racks					
HBR258	Half Base Rack	500 x 250 x 101	464 x 213	67	6
Full Size Base Cup Racks					
16C258	16-Compartment Full Cup Rack	500 x 500 x 101	111 x 111	67	6
20C258	20-Compartment Full Cup Rack	500 x 500 x 101	111 x 89	67	6
Half Size Base Cup Racks					
8HC258	8-Compartment Half Cup Rack	500 x 250 x 101	105 x 113	67	6
10HC258	10-Compartment Half Cup Rack	500 x 250 x 101	105 x 89	67	6
Full Size Full Drop Extenders – E1 and GE1					
9E1	9-Compartment Full Drop Extender	499 x 499 x 51	150 x 150	41	12
16E1	16-Compartment Full Drop Extender	499 x 499 x 51	111 x 111	41	12
20GE1	20-Compartment Full Drop Extender	499 x 499 x 51	98 x 98	41	12
25E1	25-Compartment Full Drop Extender	499 x 499 x 51	89 x 89	41	12
30GE1	30-Compartment Full Drop Extender	499 x 499 x 51	79 x 79	41	12
36E1	36-Compartment Full Drop Extender	499 x 499 x 51	73 x 73	41	12
49E1	49-Compartment Full Drop Extender	499 x 499 x 51	62 x 62	41	12

THE CAMRACK® COMPONENT SYSTEM

CODE	DESCRIPTION	EXTERIOR DIMENSIONS	COMPARTMENT	INSIDE RACK HEIGHT	CASE PACK
Full Size Half Drop Extenders – E2 and GE2					
9E2	9-Compartment Half Drop Extender	499 x 499 x 51 mm	150 x 150 mm	41 mm	12
16E2	16-Compartment Half Drop Extender	499 x 499 x 51	111 x 111	41	12
20E2	20-Compartment Half Drop Extender (for cups only)	499 x 499 x 51	111 x 89	41	12
20GE2	20-Compartment Half Drop Extender	499 x 499 x 51	98 x 98	41	12
25E2	25-Compartment Half Drop Extender	499 x 499 x 51	89 x 89	41	12
30GE2	30-Compartment Half Drop Extender	499 x 499 x 51	79 x 79	41	12
36E2	36-Compartment Half Drop Extender	499 x 499 x 51	73 x 73	41	12
49E2	49-Compartment Half Drop Extender	499 x 499 x 51	62 x 62	41	12
Full Size Open Extender – E3					
E3	Open Extender	499 x 499 x 51	457 x 457	41	12
Full Size Full Drop Extenders – E4					
16E4	16-Compartment Full Drop Extender	499 x 499 x 51	111 x 111	41	12
20GE4	20-Compartment Full Drop Extender	499 x 499 x 51	98 x 98	41	12
25E4	25-Compartment Full Drop Extender	499 x 499 x 51	89 x 89	41	12
36E4	36-Compartment Full Drop Extender	499 x 499 x 51	73 x 73	41	12
Full Size Half Drop Extenders – E5					
16E5	16-Compartment Half Drop Extender	499 x 499 x 51	111 x 111	41	12
20GE5	20-Compartment Half Drop Extender	499 x 499 x 51	98 x 98	41	12
25E5	25-Compartment Half Drop Extender	499 x 499 x 51	89 x 89	41	12
36E5	36-Compartment Half Drop Extender	499 x 499 x 51	73 x 73	41	12
Half Size Full Drop Extenders – HE1					
8HE1	8-Compartment Full Drop Extender	502 x 252 x 51	105 x 113	41	12
10HE1	10-Compartment Full Drop Extender	502 x 252 x 51	105 x 89	41	12
17HE1	17-Compartment Full Drop Extender	502 x 252 x 51	74 diameter	41	12
Half Size Half Drop Extenders – HE2					
8HE2	8-Compartment Half Drop Extender	502 x 252 x 51	105 x 113	41	12
10HE2	10-Compartment Half Drop Extender	502 x 252 x 51	105 x 89	41	12
17HE2	17-Compartment Half Drop Extender	502 x 252 x 51	74 diameter	41	12
Half Size Open Extender – HE3					
HE3	Open Extender	502 x 252 x 51	464 x 213	41	12

Base Rack Colors: Sherwood Green (119), Soft Gray (151), Brown (167), Beige (184), Navy Blue (186), Cranberry (416), Black (110)*, Red (163)*, Blue (168)*, Teal (414)*.

Base Cup Rack Color: Soft Gray (151). **Extender Color:** Soft Gray (151). *Color available in full size only. All extenders are available in Soft Gray (151). All pre-assembled racks ship with Soft Gray (151) extenders. **PlateSafe Grid Color:** Gray (000).



STOCK PRODUCTS & COLORS AVAILABLE IN OUR EUROPEAN WAREHOUSE

9E1, 9E2, 16E1, 16E2, 16E4, 16E5, 20E2, 20GE1, 20GE2, 20GE4, 20GE5, 25E1, 25E2, 25E4, 25E5, 30GE1, 30GE2, 36E1, 36E2, 36E4, 36E5, 49E1, 49E2, 16C258, 20C258: (151)
 BR258: (110), (119), (151), (163), (184), (167), (168), (186), (414), (416)
 E3: (151)

PERSONALIZED CAMRACKS®

- Personalize Camracks to identify contents at a glance for accurate inventory control and selection.
- Hot stamp a custom logo, information or standard content symbols, and/or descriptions on two opposite, diagonal sides of any rack.
- Pre-printed clips (up to 4 per rack) can be ordered factory installed for an additional charge.



IMPRINT COLOR-WHITE

HOW TO ORDER A SAMPLE

1. Contact your local Cambro rep to complete and submit a sample request form to Cambro.
2. Select rack size, code and color. Imprint color - white only.
3. Choose process A) Hot Stamp or B) Camrack Clips
4. Indicate location of hot stamp and or clip on rack. Maximum hot stamp imprint size is W 102 x H 31,7 mm. Maximum hot stamp imprinting thickness per solid letter or logo should be no more than 102 mm wide.
5. If selecting process A with a custom hot stamp, provide ready to use artwork, digital format only. Sample request form must be submitted to Cambro PRIOR to artwork being sent. If artwork is incomplete, graphic support services are available for **per hour.

6. Submit Artwork

E-mail artwork to your Cambro Rep or direct to Cambro at letsgetpersonal@cambro.com. Title e-mail subject with logo name and provide contact info.
File dimensions: 100% reproduction size, 300dpi resolution.

File type: Adobe® Illustrator®, Photoshop®
File format: jpeg, tiff, and eps.
 Or mail digital artwork to:
 CEL - Attn: C.E.L. Customer Service, Kelterstrasse 51
 72669 Unterensingen, Germany.

7. Questions regarding artwork?

Tel: (49)7022-90-100-0;
 Ireland Tel: 1800 509 046;
 for UK Tel: 0800 587 0057 or
 Fax: (49)7022-90-100-19.

8. Sample Approval

Signed approval form must be included with purchase order for processing. This form is included with each sample.

PERSONALIZATION CHARGES

- One Time Plate Charge** **for custom hot stamp only
- Set-Up Charge** **
- Sample Charge** **
- Imprint Charge** **per side, 2 sides max.

FOR CLIPS

Drinkware or PlateSafe®, pre-printed **each

**Contact your Cambro representative for pricing.

STANDARD HOT STAMP SYMBOLS AND/OR DESCRIPTIONS

Step 1. Choose a symbol and corresponding letter that best fits your glassware.

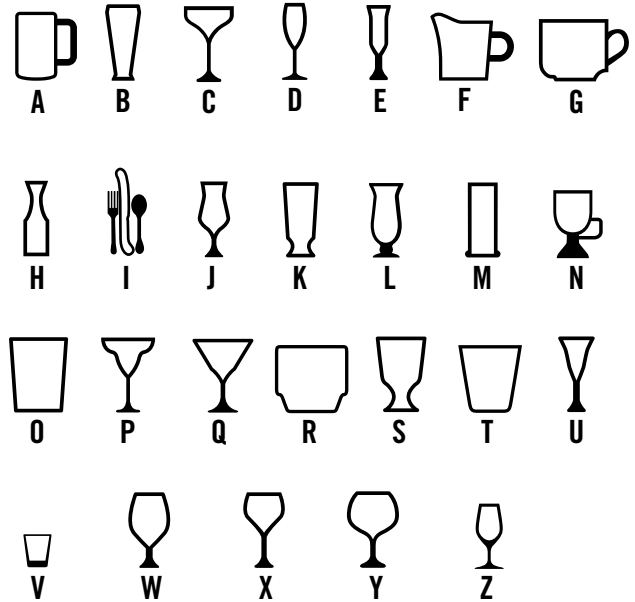

Step 2. Choose the verbiage and corresponding number that best describes your glassware. **Available in English Only.**

- | | | |
|--------------------|--------------------------|---------------------------|
| 1. Beer | 13. Flatware | 25. Rocks (Tumbler Style) |
| 2. Beer Mug | 14. Goblet | 26. Sherry |
| 3. Pilsner | 15. Grande | 27. Shot Glass |
| 4. Brandy | 16. Hi-Ball | 28. Sorbet |
| 5. Champagne | 17. Hurricane | 29. Water (Footed Style) |
| 6. Champagne Flute | 18. Iced Tea | 30. Water (Tumbler Style) |
| 7. Coffee Mug | 19. Irish Coffee | 31. White Wine |
| 8. Collins | 20. Juice | 32. Wine |
| 9. Cordial | 21. Margarita | 33. Red Wine |
| 10. Creamer | 22. Martini | 34. Port |
| 11. Cup | 23. Old Fashion | |
| 12. Decanter | 24. Rocks (Footed Style) | |

Step 3. Select hot stamp color. Choose from white, black, red or blue.

HOT STAMP OPTIONS



CUSTOM LOGO AND/OR TEXT



STANDARD SYMBOL AND DESCRIPTION



STANDARD SYMBOL ONLY



STANDARD DESCRIPTION ONLY

CAMRACK® EXTENDER ID CLIP



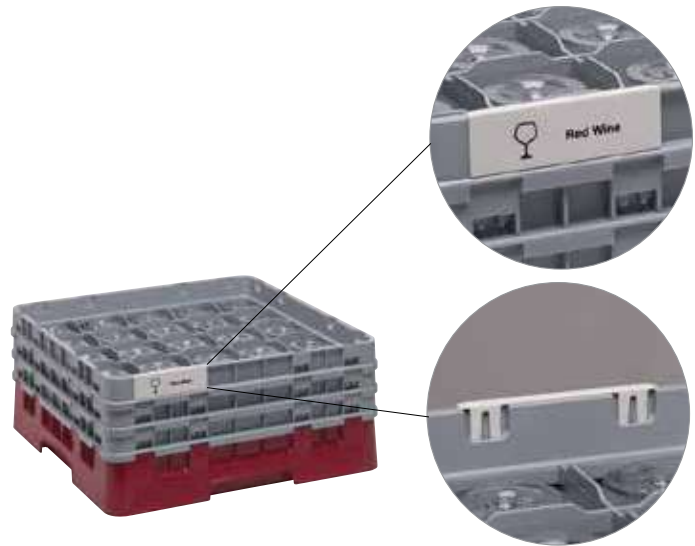































- The industry's only 4-in-1 glassware management system makes inventory management quick and easy.
- Made of ABS, these clips are virtually unbreakable, and designed to withstand the high heat of commercial dishwashers.
- An economical and sustainable solution to discarding existing racks or labeling with markers, tape or wall placards.
- Snap ID clips onto existing racks or have factory installed with new Camrack orders, up to 4 per rack, placed on the left only on each side as shown in image. Contact your Cambro representative for pricing.



PRE-PRINTED CLIPS* (Available in 6-packs only, no broken bags.)

FACTORY INSTALLED CLIPS*

*Contact your Cambro representative for pricing.

		CODE			CODE			CODE
	Beer	CECBE6000		Goblet	CECG06000		Rocks (Footed Style)	CECRF6000
	Beer Mug	CECBM6000		Grande	CECGR6000		Rocks (Tumbler Style)	CECRT6000
	Brandy	CECBR6000		Hi-Ball	CECHB6000		Sherry	CECSH6000
	Champagne	CECCH6000		Hurricane	CECHU6000		Shot Glass	CECSG6000
	Champagne Flute	CECCF6000		Iced Tea	CECIT6000		Sorbet	CECSB6000
	Coffee Mug	CECCM6000		Irish Coffee	CECIC6000		Water (Footed Style)	CECWF6000
	Collins	CECCL6000		Juice	CECJU6000		Water (Tumbler Style)	CECWT6000
	Cordial	CECCO6000		Margarita	CECMG6000		White Wine	CECWW6000
	Creamer	CECCR6000		Martini	CECMT6000		Wine	CECWI6000
	Cup	CECCP6000		Old Fashion	CECOF6000		Port	CECPO6000
	Decanter	CECDC6000		Pilsner	CECPI6000			CECBL6000 Blank Clip
	Flatware	CECFL6000		Red Wine	CECRW6000			

STOCK PRODUCTS & COLORS AVAILABLE IN OUR EUROPEAN WAREHOUSE

CECG06000, CECJU6000, CECMG6000, CECMT6000, CECOF6000, CECRW6000, CECWW6000, CECBE6000, CECCF6000, CECBL6000

(Available in English Only)

CAMDOLLIES®

- Use to easily transport multiple products in house and/or off site.
- Reduce employee lifting and carrying, reducing possible injury.
- Made of extremely durable plastic that will not dent, crack, rust or corrode.
- Heavy-duty casters maneuver easily over all types of terrain.
- For heavy transport needs, select models with handles and rear Big Wheels.

Colors: Coffee Beige (157), Dark Brown (131), Black (110), Slate Blue (401).

CDR2020, CDR2020H Color: Soft Gray (151).

Caster Type

- A:** 12,7 cm Casters: 2 fixed, 2 swivel, 1 with brake.
B: 7,6 cm Casters: 4 swivel, no brakes.
C: 25,4 cm Rear Big Wheels, 2 front 12,7 cm swivel casters, 1 with brake.
D: 8,9 cm Casters: 4 swivel, no brakes.

Available Parcel Carrier Delivery: CDR2020, CDR2020H, CD2020, CD1420, CD2028, CD1313, CD1327, CD100, CD160, CD200, CD300, CD400, CD1826PDB, 2030UT & 400STP

Camdollies Case Pack: 1

*CDR2020H Not NSF Listed.

STOCK PRODUCTS & COLORS AVAILABLE IN OUR EUROPEAN WAREHOUSE

CDR2020, CDR2020H: (151)

For Dish Racks

EXTERNAL DIM. W x D x H 54,5 x 53 x 18,7 cm

INTERIOR DIM. W x D 53 x 53 cm

159 kg CAPACITY	D CASTER TYPE
---------------------------	-------------------------



CDR2020

EXTERNAL DIM. W x D x H 53 x 64,1 x 92,7 cm

INTERIOR DIM. W x D 53 x 53 cm

159 kg CAPACITY	D CASTER TYPE
---------------------------	-------------------------



CDR2020H*
With powder coated handle.

For 46 x 66 cm Trays and Sheet Pans

EXTERNAL DIM. W x D x H 50,8 x 80 x 97,2 cm

INTERIOR DIM. W x D 46 x 66 cm

Holds: UPC101

136 kg CAPACITY	A CASTER TYPE
---------------------------	-------------------------



CD1826H

EXTERNAL DIM. W x D x H 57 x 57 x 21 cm

INTERIOR DIM. W x D 51,1 x 51,1 cm

Also Holds: 500LCD, 350LCD, 250LCD, 1000LCD, UC1000

136 kg CAPACITY	B CASTER TYPE
---------------------------	-------------------------



CD2020

EXTERNAL DIM. W x D x H 59,7 x 82,6 x 93 cm

INTERIOR DIM. W x D 47 x 66 cm

Holds: UPC101

136 kg CAPACITY	C CASTER TYPE
---------------------------	-------------------------



CD1826HB

EXTERNAL DIM. W x D x H 56,5 x 65,7 x 93,7 cm

INTERIOR DIM. W x D 51,5 x 51,5 cm

Also Holds: 250LCD, 350LCD, 500LCD, 1000LCD

159 kg CAPACITY	B CASTER TYPE
---------------------------	-------------------------



CD2020H

For Pizza Dough Boxes

Also See Pizza Dough Boxes page 167

EXTERNAL DIM. W x D x H 50,5 x 71 x 26 cm

INTERIOR DIM. W x D 44,5 x 64,5 cm

Holds: DB18263CW, DB18266CW, DB18263P

136 kg CAPACITY	A CASTER TYPE
---------------------------	-------------------------



CD1826PDB
Optional strap available.

EXTERNAL DIM. W x D x H 66,7 x 67,3 x 93 cm

INTERIOR DIM. W x D 52 x 52,5 cm

Also Holds: 250LCD, 350LCD, 500LCD

159 kg CAPACITY	C CASTER TYPE
---------------------------	-------------------------



CD2020HB

CAMDOLLIES®

For Camcarriers® and Camtainers®

EXTERNAL DIM. W x D x H 50 x 73 x 27 cm

INTERIOR DIM. W x D 44 x 66,5 cm

Holds: 100MPC, UPC100, UC250, UC500, 250LCD, 350LCD, 500LCD.

136 kg CAPACITY	A CASTER TYPE	 
---------------------------	-------------------------	---



CD100



EXTERNAL DIM. W x D x H 50 x 84 x 92 cm

INTERIOR DIM. W x D 45 x 67,5 cm

Holds: 100MPC, UC250, UC500, 250LCD, 350LCD, 500LCD.

159 kg CAPACITY	A CASTER TYPE	
---------------------------	-------------------------	---



CD100H



EXTERNAL DIM. W x D x H 60 x 83,5 x 93 cm

INTERIOR DIM. W x D 44,5 x 68 cm

Holds: 100MPC, UPC100, UC250, UC500, 250LCD, 350LCD, 500LCD.

159 kg CAPACITY	C CASTER TYPE	
---------------------------	-------------------------	---



CD100HB



EXTERNAL DIM. W x D x H 42 x 62 x 26,5 cm

INTERIOR DIM. W x D 36 x 56 cm

Holds: UPC140, UPC160, UPC180, UPCS140, UPCS160, UPCS180, UPCS160.

136 kg CAPACITY	A CASTER TYPE	 
---------------------------	-------------------------	---



CD160



EXTERNAL DIM. W x D x H 49 x 65 x 26,5 cm

INTERIOR DIM. W x D 43 x 59 cm

Holds: 300MPC, 1318MTC, UC1000, 1000LCD, UPC300, 1318CC.

159 kg CAPACITY	A CASTER TYPE	
---------------------------	-------------------------	---



CD300



EXTERNAL DIM. W x D x H 61 x 89,5 x 93 cm

INTERIOR DIM. W x D 56 x 72,5 cm

Holds: 1826MTC.

159 kg CAPACITY	A CASTER TYPE	
---------------------------	-------------------------	---



CD1826MTC

EXTERNAL DIM. W x D x H 70 x 88,5 x 93,5 cm

INTERIOR DIM. W x D 55,5 x 72,5 cm

Holds: 1826MTC.

159 kg CAPACITY	C CASTER TYPE	
---------------------------	-------------------------	---



CD1826MTCHB

EXTERNAL DIM. W x D x H 48,5 x 76,5 x 92 cm

INTERIOR DIM. W x D 43 x 59 cm

Holds: 300MPC, 1318MTC, UC1000, 1000LCD, UPC300, 1318CC.

159 kg CAPACITY	A CASTER TYPE	
---------------------------	-------------------------	---



CD300H

EXTERNAL DIM. W x D x H 60 x 76 x 92 cm

INTERIOR DIM. W x D 44 x 60 cm

Holds: 300MPC, 1318MTC, UC1000, 1000LCD, UPC300, 1318CC.

159 kg CAPACITY	C CASTER TYPE	
---------------------------	-------------------------	---



CD300HB

EXTERNAL DIM. W x D x H 53 x 70 x 23 cm

INTERIOR DIM. W x D 46 x 63,5 cm

Holds: UPC400, UPCS400, UPCH400.

136 kg CAPACITY	A CASTER TYPE	
---------------------------	-------------------------	---



Shown with
Optional Strap.

STOCK PRODUCTS & COLORS AVAILABLE IN OUR EUROPEAN WAREHOUSE

CD300: (401)
CD400: (110), (401)

CAMDOLLIES®

for Milk Crates and #10 Can Cases

EXTERNAL DIM. W x D x H 41,28 x 55,25 x 21,11 cm
INTERIOR DIM. W x D 35,24 x 49,05 cm

Holds: 35,6 x 48,3 cm Milk Crates and #10 Can Cases

159 kg CAPACITY	B CASTER TYPE
---------------------------	-------------------------



CD1420



EXTERNAL DIM. W x D x H 56,6 x 77 x 21 cm
INTERIOR DIM. W x D 49,5 x 71 cm

Holds: 35,6 x 48,3 cm Milk Crates, #10 Can Cases and UPC101, UPC400, 100MPC, UPC100, UPC300

159 kg CAPACITY	B CASTER TYPE
---------------------------	-------------------------



CD2028



EXTERNAL DIM. W x D x H 41 x 41 x 21 cm
INTERIOR DIM. W x D 35 x 35 cm

Holds: 30 x 30 cm Milk Crates

114 kg CAPACITY	B CASTER TYPE
---------------------------	-------------------------



CD1313



EXTERNAL DIM. W x D x H 40,6 x 73,7 x 21 cm
INTERIOR DIM. W x D 34,6 x 67,6 cm

Holds: 30 x 30 cm Milk Crates and #10 Can Cases

136 kg CAPACITY	B CASTER TYPE
---------------------------	-------------------------



CD1327



UTILITY TRUCKS

- Use for transporting loads up to 272 kg.
- Large platforms for convenient loading and built-in handles for easy maneuvering.
- All models feature 12,7 cm heavy-duty casters bolted into molded-in metal backing plates.

Colors: Coffee Beige (157), Dark Brown (131), Black (110), Slate Blue (401).

Casters: 12,7 cm, 2 fixed, 2 swivel, 1 with brake.

Utility Trucks Case Pack: 1

EXTERNAL DIM. W x D x H 50 x 81,5 x 98 cm
LOAD PLATFORM 50 x 75 cm

272 kg CAPACITY



2030UT
With chrome handle.

EXTERNAL DIM. W x D x H 63,2 x 106 x 93,3 cm
LOAD PLATFORM 60 x 90,5 cm

272 kg CAPACITY



2436UTH

EXTERNAL DIM. W x D x H 63,2 x 106 x 93,3 cm
LOAD PLATFORM 60 x 90,5 cm

272 kg CAPACITY



2436UTHS
Includes two straps.
UTHSTP

Camdolly® Strap for CD400 and CD1826PDB Camdollies

CODE	DESCRIPTION	EXTERNAL DIM.
400STP	Strap	381 cm long

Case Pack: 1



TRAY & DISH CARTS / TRAY & SILVERWARE CART

Tray & Dish Cart

- Open storage compartment holds a wide variety of plates and trays.
- Use with or without detachable cutlery rack. Cutlery rack includes 12 each flatware cylinders.

- Made of easy-to-clean polyethylene that won't rust, peel or corrode.
- Molded-in handles and heavy-duty swivel casters ease maneuvering.

Colors: Slate Blue (401), Coffee Beige (157), Dark Brown (131), Granite Gray (191), Granite Green (192), Black (110).

15,2 cm Casters: All swivel, 2 with brake.

Maximum load capacity: 227 kg.

Vinyl cover included. Not NSF listed.



TDCR12

CODE	DESCRIPTION	EXTERIOR DIM. L x W x H
TDCR12	Cart & rack combination	97 x 58 x 105 cm
TDC2029*	Cart only	97 x 56,5 x 87
CR12	Cutlery rack only	84 x 58 x 23
FWC56	Flatware cylinder	W 11,4 x H 14

Case Pack: 1 FWC56 Case Pack: 12

*TDC2029 is not available in Black (110).

Adjustable Tray & Dish Cart

- Use to store a wide variety of plates and trays.
- Move two adjustable dividers into position easily to secure trays and plates.

- Made of durable polyethylene that cushions plates and trays to prevent chipping.
- Easy to clean and won't dent, rust, chip or break.

Colors: Black (110), Slate Blue (401), Coffee Beige (157), Dark Brown (131), Granite Grey (191), Granite Green (192).

15,2 cm Casters: All swivel, 2 with brake.

Maximum load capacity: 227 kg.

Vinyl cover included. Not NSF listed.



TDC30

CODE	DESCRIPTION	EXTERIOR DIMENSIONS L x W x H	NUMBER OF DIVIDERS	PLATES PER COLUMN	TRAYS PER COLUMN
TDC30	Adjustable cart	59 x 99 x 88 cm	2	Approximately 45-60	80 Trays: 36 x 46 cm

Case Pack: 1

**STOCK PRODUCTS & COLORS
AVAILABLE IN OUR EUROPEAN
WAREHOUSE**

TDC30: (191)

Tray & Silverware Cart

- Use to neatly organize trays and accessories for self-service.
- Includes 4 each 1/3 size and 4 each 1/6 size, 10 cm deep, clear Camwear® food pans to hold flatware, napkins and non-perishable condiments. 1/3 size, 10 cm deep holds 100 knives, 100 spoons or 80 forks.

Colors: Slate Blue (401), Coffee Beige (157), Dark Brown (131), Granite Gray (191), Granite Green (192), Black (110).

15,2 cm Casters: All swivel, 2 with brake.

Maximum load capacity: 227 kg.

Vinyl cover included. Not NSF listed.



**STOCK PRODUCTS & COLORS
AVAILABLE IN OUR EUROPEAN WAREHOUSE**

TC1418: (401)



TC1418

CODE	DESCRIPTION	EXTERIOR DIM. L x W x H	MAXIMUM TRAY SIZE	TRAY CAPACITY
TC1418	Cart w/pans	82 x 54 x 116 cm	36 x 46 cm	180-200 in two stacks

Case Pack: 1

COMPACT ADJUSTABLE DISH CADDY R-SERIES



Securely Store & Transport Round Dishes From 11,7 to 33 cm†

† Note: Cannot be used to store square, rectangular or oval plates.

Storage Capacities

Unit holds between 45 & 60 dishes per stack, based on dish size

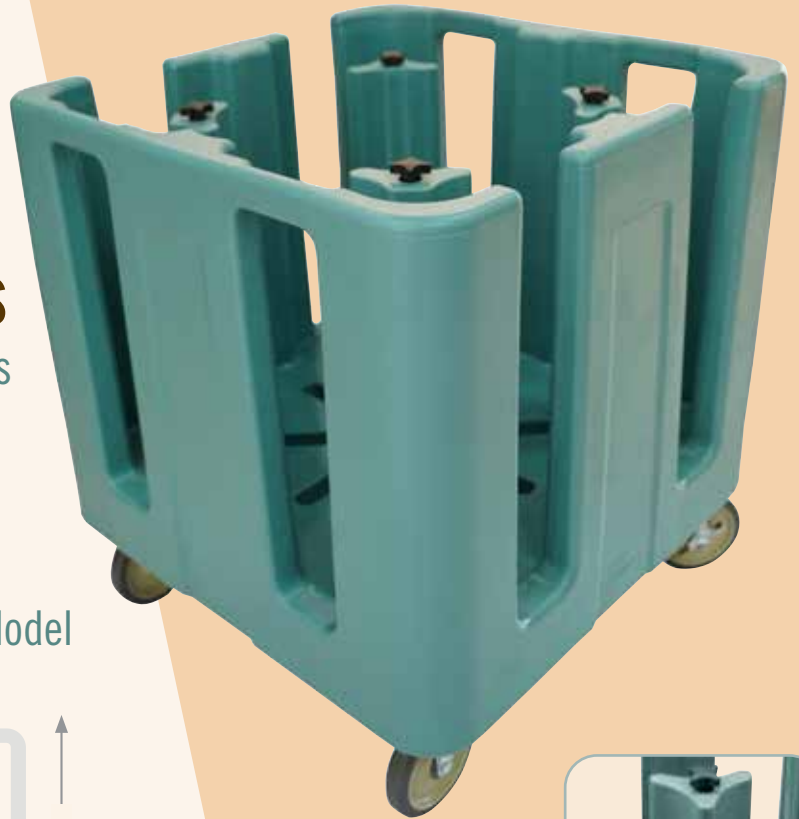

Compared to the Cambro ADC33 Model

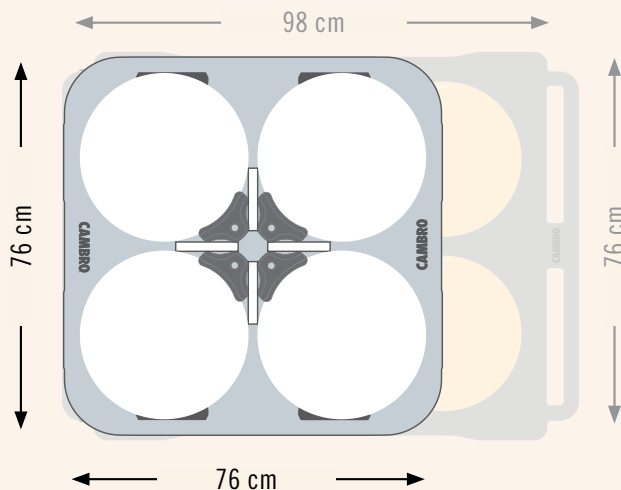

Adjustable Towers

can accommodate almost any configuration, keeping your dishware secure during transport.

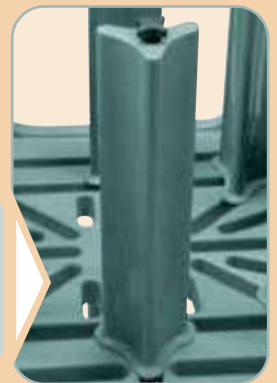

CODE	DESCRIPTION	PLATE SIZE	DIMENSIONS W x D x H	UNIT WEIGHT
ADCRC	Adjustable Dish Caddy R-Series, 4 Towers	24 cm - 33 cm	76 x 76 x 84 cm	27 kg
ADCRC8PKG*	Adjustable Dish Caddy R-Series, 8 Towers	15,24 - 23,5	—	31,3
ADCRC12PKG**	Adjustable Dish Caddy R-Series, 12 Towers	11,75 - 14,6	—	35,6
ADCRCT1	Tower - 1	—	8 x 14 x 50	1,07
ADCRCT4	Towers - 4 Each	—	—	4,31

Case Pack: 1 Colors: Black (110), Slate Blue (401), Dark Brown (131) * Ships in 2 separate cartons. ** Ships in 3 separate cartons.

COMPACT ADJUSTABLE DISH CADDY S-SERIES

- Space saving design holds dishes of various sizes without compromising capacity.
- Lightweight, easy to maneuver and access from all four sides.

Color: Speckled Gray (480).

12,7 cm Casters: 2 rigid, 2 swivel with brake.

Note: Cannot be used to store square, rectangular or oval plates.

Compact Adjustable Dish Caddy is covered by U.S. Patent 10,321,778 B2. CamLever™ Tower is covered by U.S. Patent D844, 928 S and D852,450 S.

Vinyl cover included. Not NSF listed.



Holds plates and bowls from 11,7 to 30,5 cm



Column storage height - 52,1 cm.

Maximum load capacity: 227 kg.

Molded-in handles on 4 sides.

Single molded body made of heavy-duty, durable polyethylene won't rust, crack, dent or chip.



Conveniently move and secure CamLever Towers from the top.

Holds 11,7-30,5 cm round plates/bowls only.

Smooth surface with rounded corners is easy to keep clean.



Includes protective storage cover with 7,6 x 12,7 cm inventory and/or event identification top pocket.

Gain 30% More Floor Space

Compact Adjustable Dish Caddy compared to Standard Adjustable Dish Caddy S-Series.

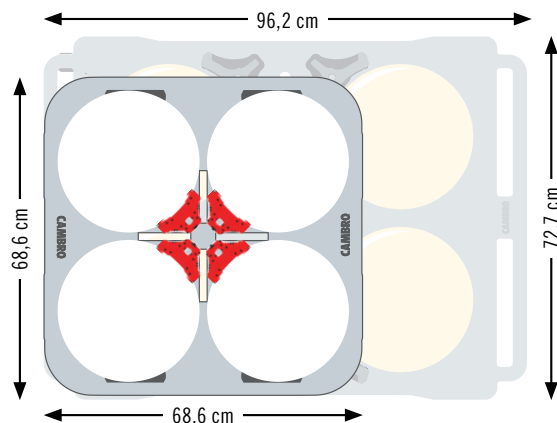

CamLever Tower

ADCSC4

DESCRIPTION:
CamLever Tower - 4 Each

OVERALL DIMENSIONS W x D x H:
6,7 x 11,1 x 59,7 cm

Case Pack: 4



Conveniently install additional CamLever Towers to convert the ADCSC to an ADCSC8PKG (8-tower) or an ADCSC12PKG (12-tower) model, holding new dish sizes.

COMPACT ADJUSTABLE DISH CADDY S-SERIES



ADCSC

DESCRIPTION:
Adjustable Dish Caddy, 4 Towers

PLATE SIZE RANGE (ROUNDS):
22,9-30,5 cm

OVERALL DIMENSIONS W x D x H:
68,6 x 68,6 x 80,7 cm

Case Pack: 1 Ships in 1 box.



ADCSC8PKG

DESCRIPTION:
Adjustable Dish Caddy, 8 Towers

PLATE SIZE RANGE (ROUNDS):
14,6-22,2 cm

OVERALL DIMENSIONS W x D x H:
68,6 x 68,6 x 80,7 cm

Case Pack: 1 Ships in 2 boxes.



ADCSC12PKG

DESCRIPTION:
Adjustable Dish Caddy, 12 Towers

PLATE SIZE RANGE (ROUNDS):
11,7-14 cm

OVERALL DIMENSIONS W x D x H:
68,6 x 68,6 x 80,7 cm

Case Pack: 1 Ships in 3 boxes.

Model: ADCSC, 4 Towers

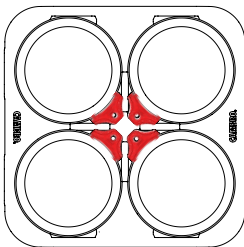

Plate sizes:
23,5 to 30,5 cm diam.
Stacks of Plates: 4
Total Capacity: 280

Model: ADCSC8PKG, 8 Towers

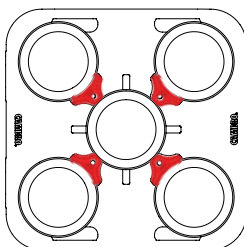

Plate sizes:
22,9 cm diam.
Stacks of Plates: 5
Total Capacity: 350

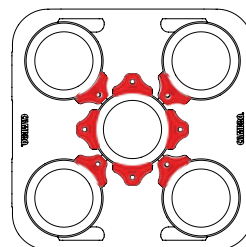

Plate sizes:
19,7 to 22,2 cm diam.
Stacks of Plates: 5
Total Capacity: 350

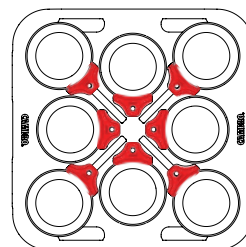

Plate sizes:
14,6 to 19,1 cm diam.
Stacks of Plates: 8
Total Capacity: 560

Model: ADCSC12PKG, 12 Towers

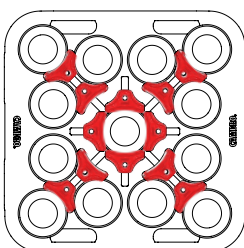

Plate sizes:
11,7 cm diam.
Stacks of Plates: 16
Total Capacity: 1,120

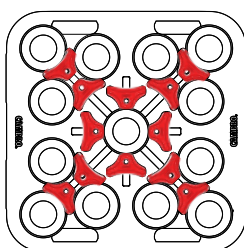

Plate sizes:
12,1 to 13,3 cm diam.
Stacks of Plates: 13
Total Capacity: 910

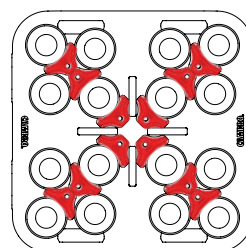

Plate sizes:
14 cm diam.
Stacks of Plates: 13
Total Capacity: 910

STOCK PRODUCTS & COLORS AVAILABLE IN OUR EUROPEAN WAREHOUSE

ADCSC, ADCSC8PKG,
ADCSC12PKG, ADCSC14: (480)

STANDARD ADJUSTABLE DISH CADDY S-SERIES

- Store one size dish or a combination of different sizes in a single caddy.
- Features easy-to-adjust column towers.

Colors: Black (110), Slate Blue (401), Speckled Grey (480), Dark Brown (131).

Casters: Two 12,7 cm, swivel with brakes and two 25,4 cm easy wheels.

Vinyl cover included. Not NSF listed.



Holds plates and bowls from 11,7 to 33 cm

Single Size Plate Storage

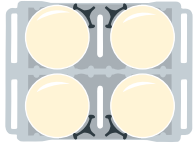

Plate sizes: ø 23,5 cm to 33 cm
4 Columns (60 each)
Total Capacity: 240

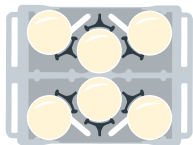

Plate sizes: ø 18,42 cm to 23,5 cm
6 Columns (60 each)
Total Capacity: 360

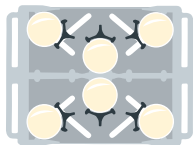
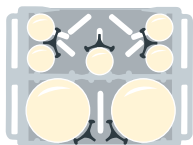

Plate sizes: ø 13,79 cm to 18,42 cm
6 Columns (45 each)
Total Capacity: 270

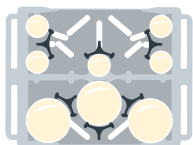

Plate sizes: 11,75 to 13,34 cm
10 columns: (45 each)
Total Capacity: 450

Mixed Size Plate Storage



2 Columns: ø 23,5 cm to 33 cm (60 each)
5 Columns: ø 11,75 to 13,34 cm (45 each)
Total Capacity: 345



3 Columns: ø 18,42 cm to 23,5 cm (60 each)
5 Columns: ø 11,75 to 13,34 cm (45 each)
Total Capacity: 405

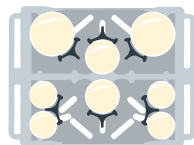

2 Columns: ø 18,42 cm to 23,5 cm (60 each)
2 Columns: ø 14,6 cm to 18,42 cm (45 each)
4 Columns: ø 11,75 to 13,34 cm (45 each)
Total Capacity: 390

STOCK PRODUCTS & COLORS AVAILABLE IN OUR EUROPEAN WAREHOUSE

ADCS: (110), (401), (480)

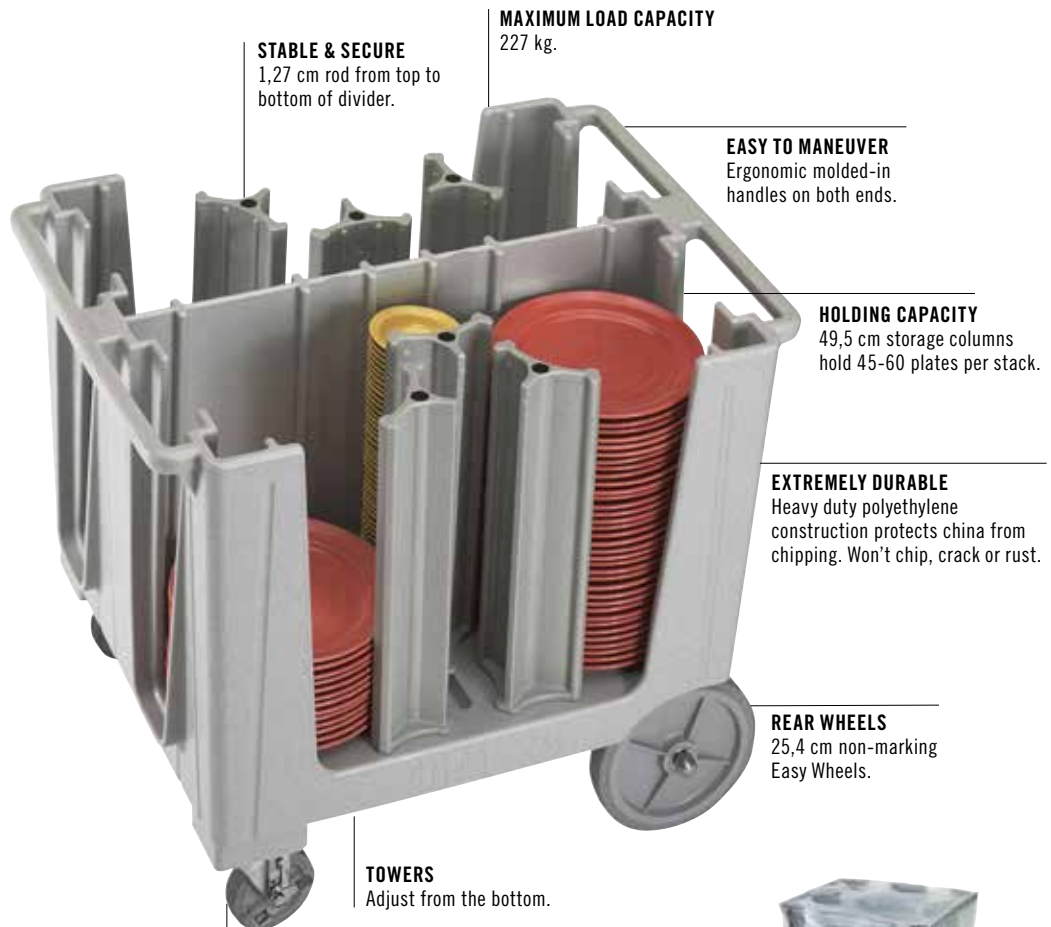

FRONT CASTERS
12,7 cm swivel with brake.



Vinyl cover included with every dolly for sanitary storage.

CODE	ADCS
NUMBER OF TOWERS	6
PLATES PER COLUMN	Approximately 45-60
OVERALL DIMENSIONS W x L x H	73 x 96 x 81 cm
Case Pack: 1	Plate size range from 11,7 to 33 cm.

ADC33 ADJUSTABLE DISH CADDY

- Unlimited versatility with fully adjustable tower dividers.
- Safely store plates, bowls, platters and trays of assorted shapes and sizes.
- Ergonomic, durable and easy to maneuver.

Colors: Dark Brown (131), Slate Blue (401).

15 cm Casters: 4 swivel with brake and 1 center rigid.

Sanitary vinyl cover included. Cover not NSF listed.



ADC33 is not available from City of Industry, California U.S.A.

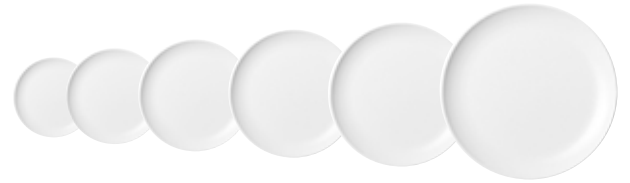

Holds dinnerware from 11 to 33 cm

CODE	ADC33
NUMBER OF DIVIDERS	6
PLATES PER COLUMN	Approximately 45-60
OVERALL DIMENSIONS W x L x H	76,2 x 98,43 x 90,17 cm

Case Pack: 1

STOCK PRODUCTS & COLORS AVAILABLE IN OUR EUROPEAN WAREHOUSE

ADC33: (401)

Ergonomic handles built flush into either side wall make the ADC33 compact and comfortable to handle.



ADC33

15,24 cm swivel casters with brakes at each corner.

Rigid caster in center of the unit makes maneuvering a breeze, even when fully loaded.

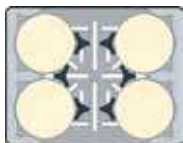

6 Dividers:
4 stacks (11-33 cm) Rounds

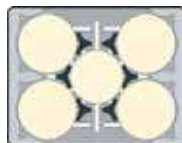

6 Dividers:
4 stacks (11-33 cm) Rounds +
1 stack (17.5-30 cm) Rounds

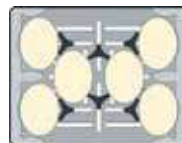

6 Dividers:
6 stacks
(20,3-29,2 x 12,7-21,9 cm) Ovals

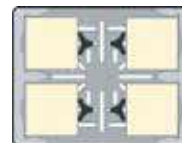

4 Dividers:
4 stacks (25-28,8 cm) Squares

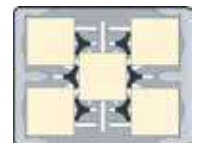

6 Dividers:
5 stacks (24-27,9 cm) Squares



12 Dividers:
6 stacks (15,2-20,3 cm)
Squares or Rounds



4 Dividers:
1 stack (35-73,6 cm) long x
up to (59,9 cm) wide Oval trays



6 Dividers:
4 stacks Ovals
(29,2 x 21,9 cm); 1 stack
40,6 cm Round Tray

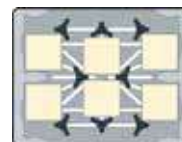

8 Dividers:
6 stacks (20,3 cm)
Medium Squares

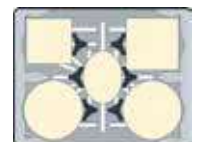

6 Dividers:
2 stacks (33,7 cm) Large Rounds,
1 stack (25,4 cm) Medium Squares,
1 stack (29,2 cm) Large Squares,
1 stack (29,2 x 21,9 cm) Medium
Ovals

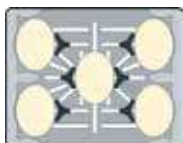

6 Dividers:
5 stacks (29,2 x 21,9 cm) Ovals

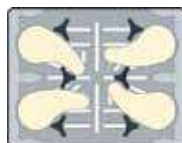

6 Dividers:
4 stacks Custom Plates

POKER CHIP "FIXED" NON ADJUSTABLE DISH CADDIES

- Dividers are molded into the body in a standard poker chip design.
- Made of durable polyethylene that protects plates from chipping.
- Rear big wheels and front swivel casters provide smooth maneuvering.
- Open access from two sides for easy loading and unloading.
- Molded-in handles on both ends for easy transporting.

Standard Caddy Colors: Black (110), Slate Blue (401), Dark Brown (131), Granite Gray (191).

Versa Caddy Colors: Black (110), Dark Brown (131), Speckled Gray (480).

Casters: 12,7 cm swivel with brakes and two 25,4 cm Easy Wheels.

Loading Capacity: 227 kg.

Vinyl cover included. Not NSF listed.

DCS950 is covered by U.S. Patent D 603,120 S. DCS1125 is covered by U.S. Patent D 625,894.



Standard Dish Caddies



DC575
PLATE SIZE RANGE (ROUNDS):
 14,6 cm
STACKS PER CADDY: 6
PLATES PER STACK: 45-60
OVERALL DIMENSIONS W x L x H:
 83 x 60 x 81 cm
Case Pack: 1



DC700
PLATE SIZE RANGE (ROUNDS):
 14,9-17,8 cm
STACKS PER CADDY: 6
PLATES PER STACK: 45-60
OVERALL DIMENSIONS W x L x H:
 83 x 60 x 81 cm
Case Pack: 1



DC825
PLATE SIZE RANGE (ROUNDS):
 18,1-21 cm
STACKS PER CADDY: 4
PLATES PER STACK: 45-60
OVERALL DIMENSIONS W x L x H:
 73 x 60,5 x 81,5 cm
Case Pack: 1



DC1225
PLATE SIZE RANGE (ROUNDS):
 28,9-31,1 cm
STACKS PER CADDY: 4
PLATES PER STACK: 45-60
OVERALL DIMENSIONS W x L x H:
 83 x 70 x 81,5 cm
Case Pack: 1

Versa Dish Caddies

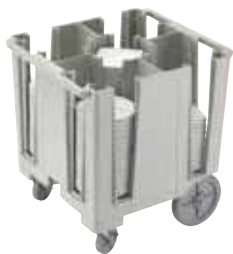

DCS950
PLATE SIZE RANGE (ROUNDS):
 21,3-24,1 cm
PLATE SIZE RANGE (SQUARES):
 18,4-20,5 cm
STACKS PER CADDY: 5
PLATES PER STACK: 45-60
OVERALL DIMENSIONS W x L x H:
 69 x 78 x 81 cm
Case Pack: 1



DCS1125
PLATE SIZE RANGE (ROUNDS):
 24,4-28,6 cm
PLATE SIZE RANGE (SQUARES):
 21,3-24,1 cm
STACKS PER CADDY: 4
PLATES PER STACK: 45-60
OVERALL DIMENSIONS W x L x H:
 69 x 78 x 81 cm
Case Pack: 1

STOCK PRODUCTS & COLORS AVAILABLE IN OUR EUROPEAN WAREHOUSE

DCS950, DCS1125: (480)



CAMBOX® BUSSING BOXES

Regal (ABS)



CODE	1120CBR	1520CBR
DESCRIPTION	Four compartment cutlery box	Cambox
DIM. W x L x H	28,9 x 52 x 9,5 cm	38,9 x 50,6 x 12,5 cm

Case Pack: 12 Colors: Black (110), Dark Brown (131).



CODE	2115CBR	21157CBR	1722CBR
DESCRIPTION	Cambox	Cambox	Cambox
DIM. W x L x H	38,7 x 51,4 x 12,5 cm (incl. handle)	38,6 x 51,2 x 17,6 cm	42,9 x 55,6 x 12,1 cm
COVER	2115CBCR	2115CBCR	1722CBCP

Case Pack: 12 Colors: Black (110), Dark Brown (131).



Polyethylene



CODE	415CBP	912CBP	1120CBP	1520CBP & 1520CBPF*
DESCRIPTION	Cutlery Box	Utility Box	Four compartment cutlery box	Cambox
DIM. W x L x H	11,3 x 36 x 10,3 cm	23 x 30,6 x 13 cm	28,9 x 52 x 9,5 cm	38,9 x 50,6 x 12,5 cm
COVER	—	—	—	1520CBCP

Case Pack: 12 Colors: Black (110), Dark Brown (131), Light Grey (180). *1520CBPF is identical to our current 1520CBP except the internal surface is flat.



CODE	1621CBP	21155CBP	21157CBP	1722CBP
DESCRIPTION	Cambox	Cambox	Cambox	Cambox
DIM. W x L x H	39,7 x 52 x 12,4 cm	38,7 x 51,4 x 12,5 cm (incl. handle)	38,6 x 51,2 x 17,6 cm	42,9 x 55,6 x 12,1 cm
COVER	—	2115CBCP	2115CBCP	1722CBCP

Case Pack: 12 Colors: Black (110), Dark Brown (131), Light Grey (180).

Box Covers



CODE	1520CBCP	1722CBCP	2115CBCP	2115CBCR
FITS	1520CBP	1722CBR, 1722CBP	21155CBP, 21157CBP	21155CBR, 21157CBR
DIM. W x L	40,6 x 52 cm	44 x 56,8 cm	39,4 x 52 cm	39,4 x 52 cm

Case Pack: 12 Color: White (148).



SERVICE CART PRO

A complete line of small, medium, and large service carts, designed to elevate operational efficiency in any type of foodservice operation. Sturdy, strong and durable with a sleek, modern look that rolls easily between front and back of the house.

- Three durable shelves feature raised ridges to protect surface against heat. Shelf surfaces are lightly textured (top only), stain resistant and easy to clean.
- Two molded-in ergonomic handles on each end of the cart are recessed, flush to the body, to save space.
- Middle and bottom shelves have a 2 cm raised edge on one side to help keep items in place.
- Choose 4 swivel when maneuvering in and out of tight spaces is needed.

Colors: Black (110), Dark Brown (131), Charcoal Gray (615).

Service Cart PRO and Quick Connect Bins are covered by US Patents D882,203 S, D883,755 S, and D885,003 S.



SC330

EXTRA STABILITY
3,8 cm raised rail on top shelf;
2 cm rail on one side of lower
shelves to secure contents.

SPACE MAXIMIZER
Molded-in handles for compact
storage, shielded from damage.

MORE OPTIONS

Quick Connect Bins for trash, dirty utensils or extra storage fit securely below handles.



EXTRA TOUGH & SUSTAINABLE
Built for heavy-duty use; resists
chips, dents, rust, and stains.



SMOOTH, QUIET MANEUVERING

Heavy-duty, non-marking
plate casters. Choose from
2 configurations.

HOT PAN PROTECTION
Shelves with raised cooling
ribs to withstand hot pans.

NOTE: Best to cool metal pans to
121°C before placing on cart.



PERSONALIZATION
Contact your Cambro
representative for pricing.

SERVICE CART PRO

TOTAL WEIGHT CAPACITY
272 kg

90,7 kg
PER SHELF



Top Shelf Dimension (L x D Inside Rails)
82,9 x 50,1 cm

Vertical open space between each shelf is 27,6 cm

Caster Size: 15 x 3,8 cm

Large

CODE	CASTERS	INTERIOR SHELF DIMENSIONS L x D x H	CART DIMENSIONS L x D x H	UNIT WEIGHT
SC337	2 Rigid, 2 Swivel with Brake	87 x 55 x 27,6 cm	105,4 x 60 x 94,6 cm	27,4 kg
SC337S	4 Swivel, All with Brake	87 x 55 x 27,6 cm	105,4 x 60 x 94,6 cm	28,2 kg

TOTAL WEIGHT CAPACITY
272 kg

90,7 kg
PER SHELF



Top Shelf Dimension (L x D Inside Rails)
72,4 x 45,7 cm

Vertical open space between each shelf is 27,6 cm

Caster Size: 15 x 3,8 cm

Medium

CODE	CASTERS	INTERIOR SHELF DIMENSIONS L x D x H	CART DIMENSIONS L x D x H	UNIT WEIGHT
Open Sides				
SC230	2 Rigid, 2 Swivel with Brake	77,1 x 53,3 x 27,6 cm	95,3 x 55,9 x 94,6 cm	23,6 kg
SC230S	4 Swivel, All with Brake	77,1 x 53,3 x 27,6 cm	95,3 x 55,9 x 94,6 cm	24,4 kg
One Closed Side				
SC330	2 Rigid, 2 Swivel with Brake	77,1 x 50,8 x 27,6 cm	95,3 x 55,9 x 94,6 cm	26,7 kg
SC330S	4 Swivel, All with Brake	77,1 x 50,8 x 27,6 cm	95,3 x 55,9 x 94,6 cm	27,6 kg

TOTAL WEIGHT CAPACITY
176,9 kg

59 kg
PER SHELF



Top Shelf Dimension (L x D Inside Rails)
60 x 35,6 cm

Vertical open space between each shelf is 27,6 cm

Caster Size: 7,6 x 3,2 cm

Small

CODE	CASTERS	INTERIOR SHELF DIMENSIONS L x D x H	CART DIMENSIONS L x D x H	UNIT WEIGHT
SC225	2 Rigid, 2 Swivel with Brake	65,4 x 41,9 x 27,6 cm	79,4 x 45,7 x 86,4 cm	16,3 kg
SC225S	4 Swivel, All with Brake	65,4 x 41,9 x 27,6 cm	79,4 x 45,7 x 86,4 cm	17,1 kg

Case Pack: 1 Service Pro Cart Colors: Black (110), Dark Brown (131), Charcoal Gray (615).

Optional Accessories

CODE	DESCRIPTION	EXTERIOR DIM. L x W x H
QCSB	Small Quick Connect Bin	40,6 x 17,8 x 30,9 cm
QCTB	Large Quick Connect Bin	40,6 x 17,8 x 54 cm

Case Pack: 1 Colors: Black (110)



QCTB



QCSB

Optional Quick Connect Bins slide and lock onto molded-in dovetails positioned safely below the handles.

KD SERVICE CART AND KD UTILITY CART

- Versatile, durable and economically-priced carts.
- Marine rails and lightly-textured polypropylene shelves keep contents in place.
- Aluminum uprights ensure stability.
- Ships “knocked down” to minimize shipping costs.
- Easy to assemble.

Cart and Shelf Panel Set Colors:
Black (110), Speckled Grey (480).

Trash Container and Silverware Holder Color: Black (110).



Each BC340KD shelf holds one full-sized dish rack or two standard bus boxes.

Marine rails keep contents in place.

Optional shelf panels can be added at time of assembly to enclose three sides. (KD Utility Cart only.)

Sturdy aluminum uprights.

Four powder coated steel swivel casters provide quiet transport and steady maneuvering.

BC340KD

Durable, stain-resistant surface is easy to clean.

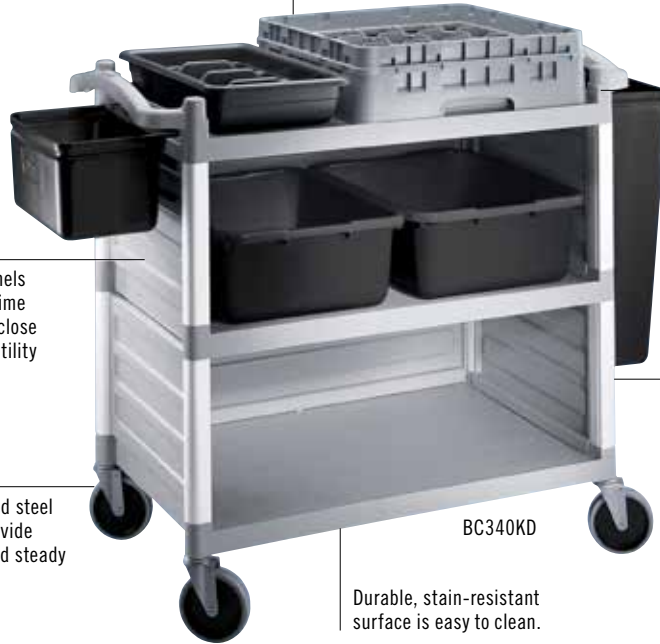

STOCK PRODUCTS & COLORS AVAILABLE IN OUR EUROPEAN WAREHOUSE

BC331KD, BC340KD, BC340KDP: (480), (110)
BC331KDTc, BC331KDSh: (110)



camguard

ANTIMICROBIAL HANDLES



Shown with optional shelf panels on single shelf.

CODE	BC340KD	BC331KD
DESCRIPTION	Large Utility Cart	Small Service Cart
CASTER DIA./TYPE	12,7 cm, 4 swivel, no brake	10,2 cm, 4 swivel, no brake
OVERALL DIM. L x D x H	101,6 x 54 x 95,25 cm	83,5 x 41 x 96,5 cm
SHELF DIM. L x D x H	80 x 52 x 29,8 cm	62 x 40 x 30 cm
LOAD CAPACITY	180 kg	136 kg

Case Pack: 1

Optional Accessories



CODE	BC331KDTc	BC331KDSh	BC340KDP
DESCRIPTION	30 L Trash container	9,5 L Silverware holder	Single Shelf Panel Set for KD Large Utility Cart 1 side, 2 ends
DIM. W x D x H	33 x 24 x 56 cm	33 x 24 x 18,5 cm	80,3 x 45 x 29,8 cm

Case Pack: 1



S H E L V I N G f o r L I F E[®]



When we say Shelving for Life, we mean it. All Camshelving[®] storage systems are designed to withstand the toughest conditions and the harshest environments. With our lifetime warranty against rust and corrosion, only Cambro offers SHELIVING for LIFE[™].



Cambro storage and transportation products that support safe food handling.



Products that meet the NSF International criteria for sanitation and cleanability.



Products that help meet HACCP guidelines.



Certifies products approved by Technischer Überwachungs-Verein. (Technical Inspection Association)



Fit for food products



Dishwasher Safe



Cadmium-free products



Recyclable polypropylene



Antimicrobial protection permanently molded into shelf plates to inhibit the growth of mold, fungus and bacteria.

Camshelving[®] is covered under the following U.S. Patents:

D498,664 S, D508,646 S, D512,867 S, D623,929 S, D624,764 S, D648,582 S, D630,935 S, D648,159 S, D651,433 S, D648,160 S, D697,391 S, D727,715 S, D728,347 S, D728,348 S, D707,994 S, D739,989 S, D663,912 S, D736,488 S, D739,989 S, D760,519 S, D841, 273 S, D828, 145 S, D827, 421 S US 6,981,454B2

CAMSHELVING®

SHELVING for LIFE™

KEY FEATURES OF ALL CAMSHELVING SERIES



Rust and Corrosion Free

Backed by a lifetime warranty against rust and corrosion. All Camshelving is impervious to harsh chemicals and salt water.

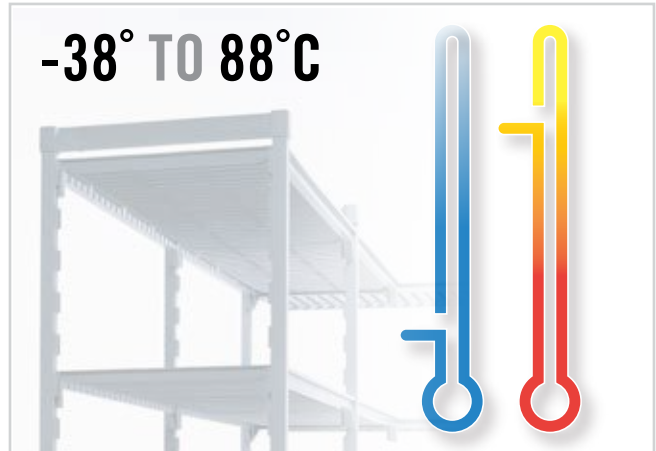

All Environments

Camshelving is designed to withstand all extreme storage applications and temperatures.

- Coolers
- Freezers
- Dry Storage
- Utility

Maximized Space Utilization

Shelving units are designed to be interconnected, without compromising weight-bearing capacity, all while maximizing usable storage space.

Starter Unit

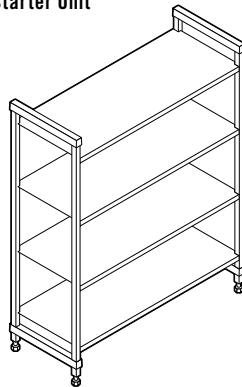

Starter + Add-On Unit

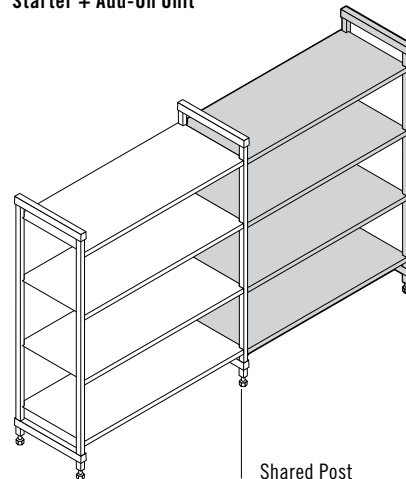

PREMIUM® series ELEMENTS® XTRA series BASICS® PLUS series



Easy to Clean

Camshelving easily wipes clean or shelf plates can go through the dishwasher. Camguard® antimicrobial shelf plates inhibit the growth of harmful bacteria and microbes.



Easy to Assemble & Adjust

Units ship with preassembled frames to speed up installation. Each shelf can be easily and independently adjusted.

Corner Unit
Starter + Add-On Unit

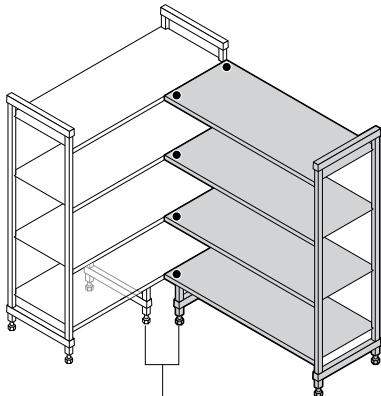

U-Shape Unit
Two Starter Units +
Intermediate Shelves

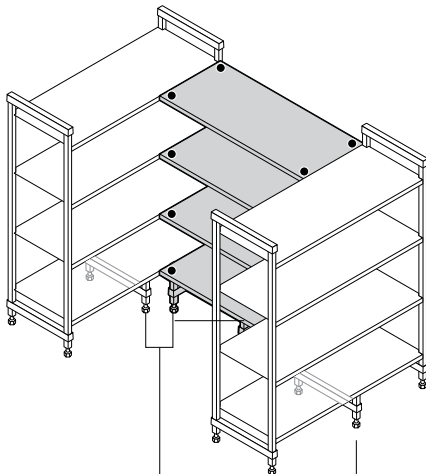

T-Shape Unit
Starter unit + Add-on Unit

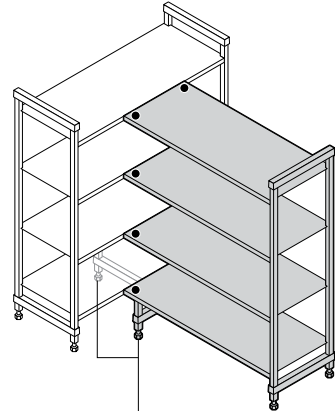

Bottom Shelf
Dunnage Stands

Convert unusable space into continuous, easy-access storage areas with corner connectors. ●
Corner connectors are for use only with shelves 680 – 1280 mm long.

CAMSHELVING® SERIES BUYERS GUIDE

All Camshelving lines offer a lifetime warranty against rust and corrosion for shelf plates, posts and traverses.



	PREMIUM series	ELEMENTS XTRA series	BASICS PLUS series
Shelf Depths	300, 400, 500, 600 mm	360, 460, 540, 610 mm	360, 460, 540, 610 mm
Shelf Lengths	680, 780, 880, 980, 1080, 1180, 1280, 1380, 1480, 1580, 1680, 1780 mm	610, 765, 915, 1070, 1220, 1375, 1525, 1830 mm	765, 915, 1070, 1220, 1375, 1525mm
Post Heights	Stationary: 1700, 1800, 2140 mm Mobile: 1790 mm (includes casters)	Stationary: 765, 915, 1070, 1220 mm Mobile: 1778, 1980 mm (includes casters)	Stationary: 1630, 1830, 2140 mm
Weight-Bearing Capacity	Stationary Unit: 200 kg per shelf, 800 kg per unit. Mobile Unit: 340 kg per unit. Corner Unit: 180 kg per shelf, 810 kg per unit. (2 dunnage stands required)	Stationary Unit: 365 kg per shelf, 1090 kg per unit. Mobile Unit: 340 kg per unit. Corner Unit: 365 kg per shelf, 1090 kg per unit. (2 dunnage stands required)	Stationary Unit: 190 kg per shelf, 800 kg per unit. Corner Unit: 130 kg per shelf, 590 kg per unit. (2 dunnage stands required)
Shelf Plates	Interchangeable with Elements XTRA Series. Features Camguard® antimicrobial.	Interchangeable with Premium Series. Features Camguard antimicrobial.	Not interchangeable with Premium or Elements XTRA Series. Features Camguard antimicrobial.
Mobility	Available in Mobile and High Density Storage System.	Available in Mobile and High Density Storage System.	Not available.
Assembly	Quickest and easiest to assemble due to molded-in dovetails.	Simple to assemble. Contains separate dovetails that must be attached to the post.	Simple to assemble. Contains separate dovetails that must be attached to the post.
ACCESSORIES			
Bottom Shelf Dunnage Stand	✓	✓	✓
Shelf Rails	✓	✓	✓
Vertical Drying and Storage Cradle (Trays / Cutting Boards / Lids)	✓	✓	✓
Dome Drying and Storage Cradle	✓	✓	✓
Angled Drying and Storage Cradle	✓	✓	✓
Ultimate #10 Can Rack	✓	✓	
Shelf Divider Panel	✓	✓	✓
Shelf Divider Bar (for Food Pans or Food Boxes)	✓	✓	
Single Shelf Sheet Pan/Tray Rack	✓	✓	✓
Single Shelf Security Cage	✓	✓	✓
Full Wrap Security Cage	✓		

FREE CAMSHELVING® DESIGN SERVICE

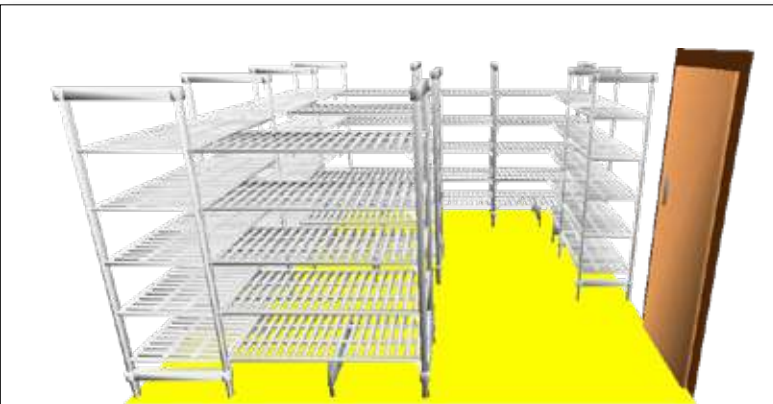

Take the guesswork out of creating your perfect shelving layout. Let our expert shelving consultants prepare a free layout that optimizes your space to create the most storage options.

Here's what you'll get:

- 2D Floor Plan
- 3D Floor Plan
- Itemized product list by room/area
- All within 48 business-day hours

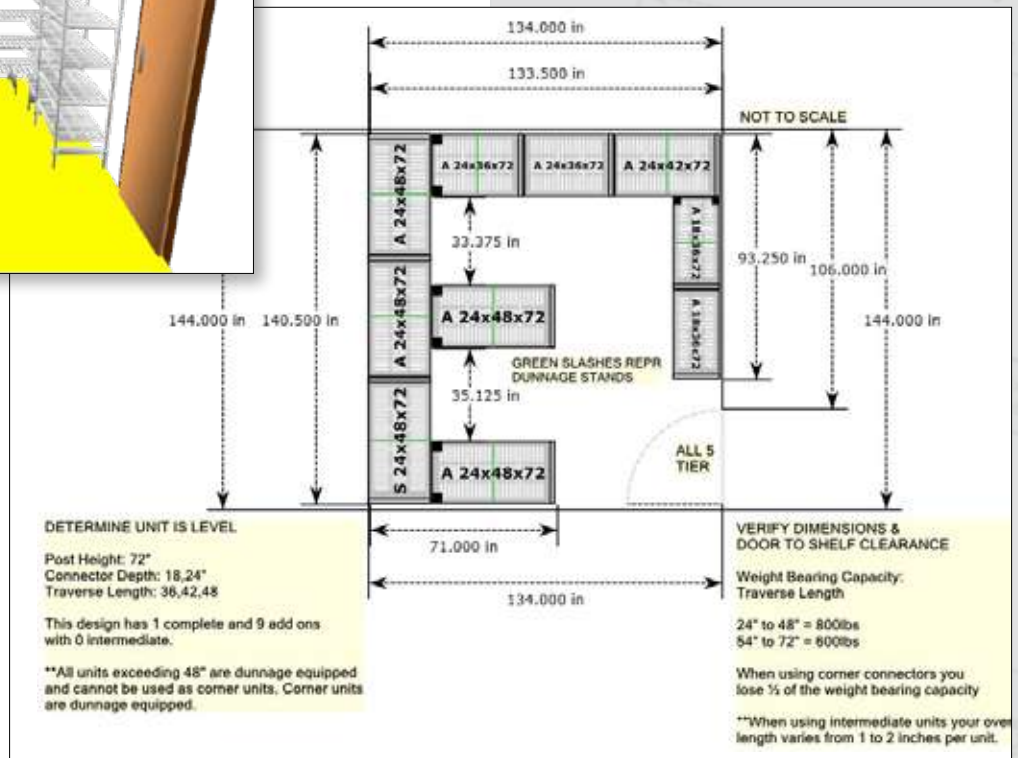

It's Simple! To Get Started, Please Provide:

- Project Name
- Storage Room Type (freezer / cooler)
- Room(s) Dimensions (L x W x H)
- Doorway / Entryway Location & Dimension
- Obstructions (condenser / pipes)
- Additional Preferences / Requirements

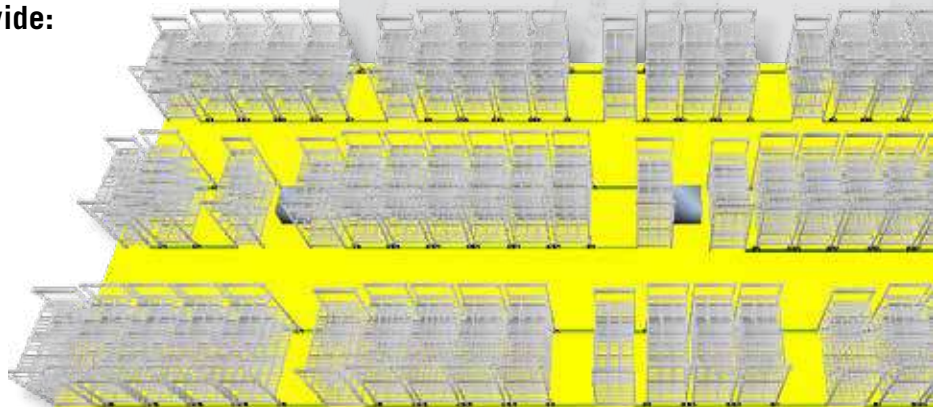

Request a Free
3D Shelving Layout

CAMSHELVING® SERIES OVERALL LENGTH – QUICK REFERENCE GUIDE

Straight Unit: Starter Unit + Add-On Unit with Shared Posts

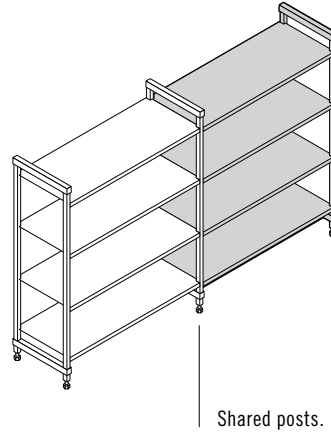
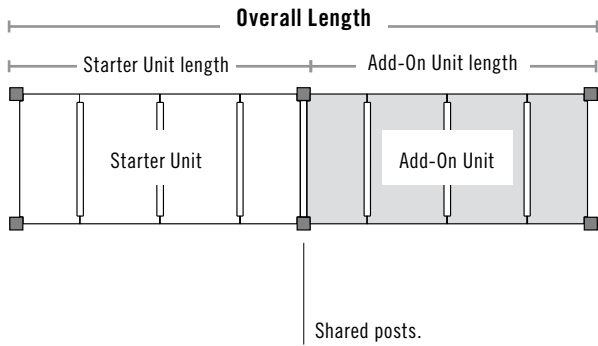

Corner Unit: Starter Unit + Add-On Unit with Corner Connectors

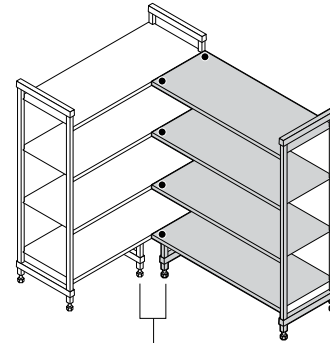
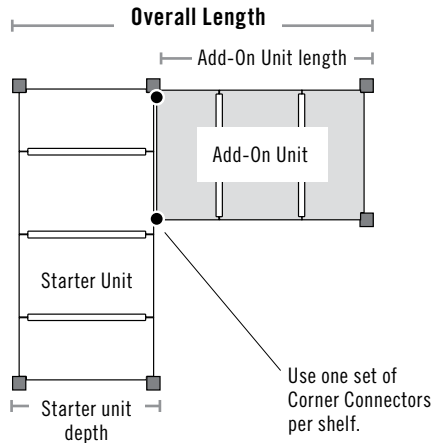

U-Shape Unit: Two Starter Units + Intermediate Shelves with Corner Connectors

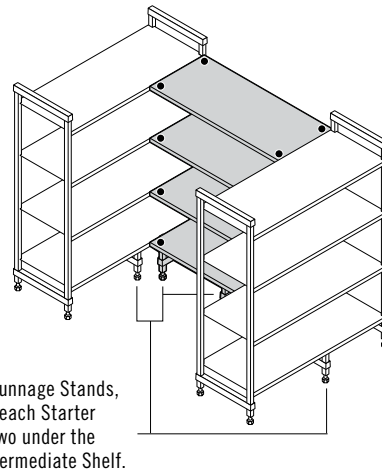
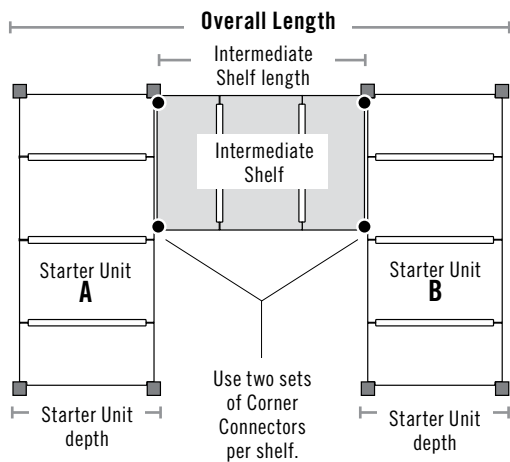

Straight Unit: Starter Unit + Add-On Unit with Shared Posts

PREMIUM SERIES				ELEMENTS XTRA® SERIES				BASICS PLUS SERIES			
STARTER & ADD-ON UNIT	STARTER UNIT ACTUAL LENGTH	ADD-ON UNIT ACTUAL LENGTH	OVERALL LENGTH	STARTER UNIT ACTUAL LENGTH	ADD-ON UNIT ACTUAL LENGTH	OVERALL LENGTH	STARTER UNIT ACTUAL LENGTH	ADD-ON UNIT ACTUAL LENGTH	OVERALL LENGTH		
600 mm	680 mm	+ 635 mm	= 1315 mm	610 mm	+ 559 mm	= 1169 mm	765 mm	+ 718 mm	= 1483 mm		
700	780	+ 735	= 1515	765	+ 712	= 1477	915	+ 870	= 1785		
800	880	+ 835	= 1715	915	+ 864	= 1779	1070	+ 1023	= 2093		
900	980	+ 935	= 1915	1070	+ 1016	= 2086	1220	+ 1175	= 2395		
1000	1080	+ 1035	= 2115	1220	+ 1169	= 2389	1375	+ 1328	= 2703		
1100	1180	+ 1135	= 2315	1375	+ 1321	= 2696	1525	+ 1480	= 3005		
1200	1280	+ 1235	= 2515	1525	+ 1474	= 2999	1830	+ 1785	= 3615		
1300	1380	+ 1335	= 2715	1830	+ 1778	= 3608					
1400	1480	+ 1435	= 2915								
1500	1580	+ 1535	= 3115								
1600	1680	+ 1635	= 3315								
1700	1780	+ 1735	= 3515								

Corner Unit: Starter Unit + Add-On Unit with Corner Connectors

PREMIUM SERIES				PREMIUM SERIES				PREMIUM SERIES			
ADD-ON UNIT	ADD-ON UNIT ACTUAL LENGTH	STARTER UNIT DEPTH	OVERALL LENGTH	ADD-ON UNIT ACTUAL LENGTH	STARTER UNIT DEPTH	OVERALL LENGTH	ADD-ON UNIT ACTUAL LENGTH	STARTER UNIT DEPTH	OVERALL LENGTH		
600 mm	655 mm	+ 400 mm	= 1035 mm	655 mm	+ 500 mm	= 1155 mm	655 mm	+ 600 mm	= 1255 mm		
700	755	+ 400	= 1135	755	+ 500	= 1255	755	+ 600	= 1355		
800	855	+ 400	= 1235	855	+ 500	= 1355	855	+ 600	= 1455		
900	955	+ 400	= 1335	955	+ 500	= 1455	955	+ 600	= 1555		
1000	1055	+ 400	= 1435	1055	+ 500	= 1555	1055	+ 600	= 1655		
1100	1155	+ 400	= 1535	1155	+ 500	= 1655	1155	+ 600	= 1755		
1200	1255	+ 400	= 1635	1255	+ 500	= 1755	1255	+ 600	= 1855		
ELEMENTS XTRA / BASICS PLUS SERIES				ELEMENTS XTRA / BASICS PLUS SERIES				ELEMENTS XTRA / BASICS PLUS SERIES			
610	585	+ *458	= 1045	585	+ *534	= 1119	585	+ *610	= 1195		
765	737	+ 458	= 1200	737	+ 534	= 1271	737	+ 610	= 1347		
915	889	+ 458	= 1350	889	+ 534	= 1423	889	+ 610	= 1499		
1070	1042	+ 458	= 1505	1042	+ 534	= 1576	1042	+ 610	= 1652		
1220	1194	+ 458	= 1655	1194	+ 534	= 1728	1194	+ 610	= 1804		

610 mm unit not available in Camshelving Basics Plus Series. *Actual depth.

U-Shape Unit: Two Starter Units + Intermediate Shelves with Corner Connectors

PREMIUM SERIES				PREMIUM SERIES				PREMIUM SERIES			
INTERMEDIATE SHELF	INTERMEDIATE SHELF ACTUAL LENGTH	400 MM DEPTH STARTER UNIT A+B	OVERALL LENGTH	INTERMEDIATE SHELF ACTUAL LENGTH	500 MM DEPTH STARTER UNIT A+B	OVERALL LENGTH	INTERMEDIATE SHELF ACTUAL LENGTH	600 MM DEPTH STARTER UNIT A+B	OVERALL LENGTH		
800 mm	830 mm	+ 800 mm	= 1630 mm	830 mm	+ 1000 mm	= 1830 mm	830 mm	+ 1200 mm	= 2030 mm		
900	930	+ 800	= 1730	930	+ 1000	= 1930	930	+ 1200	= 2130		
1000	1030	+ 800	= 1830	1030	+ 1000	= 2030	1030	+ 1200	= 2230		
1100	1130	+ 800	= 1930	1130	+ 1000	= 2130	1130	+ 1200	= 2330		
1200	1230	+ 800	= 2030	1230	+ 1000	= 2230	1230	+ 1200	= 2430		
ELEMENTS XTRA / BASICS PLUS SERIES				ELEMENTS XTRA / BASICS PLUS SERIES				ELEMENTS XTRA / BASICS PLUS SERIES			
915 mm	864 mm	+ *915 mm	= 1779 mm	864 mm	+ *1067 mm	= 1931 mm	864 mm	+ *1220 mm	= 2084 mm		
1070	1016	+ 915	= 1931	1016	+ 1067	= 2083	1020	+ 1220	= 2236		
1220	1169	+ 915	= 2084	1169	+ 1067	= 2236	1170	+ 1220	= 2389		

*Actual depth.

CAMSHELVING®

PREMIUM

series

STATIONARY | MOBILE | HIGH DENSITY

- Posts and traverses have a steel core and smooth polypropylene exterior for superior strength and durability.
- Traverse dovetails are molded into posts every 10,2 cm.
- Polypropylene shelf plates with permanent, molded-in Camguard®, an antimicrobial technology that inhibits the growth of mold, fungus, and bacteria.
- Sturdy reinforced threaded nylon foot adjusts easily to level units.
- Withstands storage temperatures from -38° to 88°C.
- Lifetime warranty against rust and corrosion.



"Lock tab" design solidly "locks" both post and post connector together for enhanced stability.

Connectors remain engaged on posts even under the most rigorous and demanding storage conditions.



camguard
ANTIMICROBIAL SHELF PLATES



Posts, Traverses, Shelf Plates, Dunnage Stand Saddle, Post Connectors, Corner Connectors, Floor Fastener, Wall Fastener, Identification Tags, Single Shelf Security Cage, Tray Slide Rack, Ultimate #10 Can Rack, Shelf Divider Bars, High Density Track and Extension Kits are not NSF Listed.

Only available from Cambro European Logistics (CEL), Germany and Cambro Özay Turkey.

CAMSHELVING® PREMIUM SERIES

STARTER UNITS

Ship complete in 1 box. Includes factory assembled post frames for quicker assembly.

*Units ship in separate post kit (unassembled) and shelf kit cartons due to overall weight.

Stationary

4 Depths	12 Lengths		3 Heights
300 mm	680 mm	1280 mm	1700 mm
400	780	1380	1800
500	880	1480	2140
600	980	1580	
	1080	1680	
	1180	1780	

Standard Mobile

3 Depths	5 Lengths	1 Heights
400 mm	980 mm	1790 mm
500	1080	
600	1180	
	1280	
	1380	

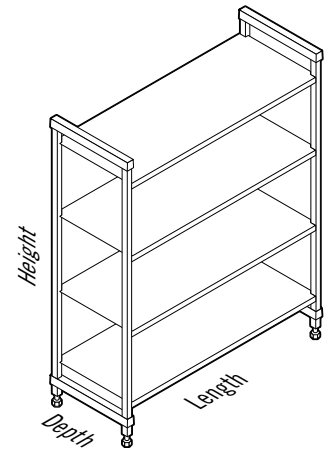

High Density Mobile

2 Depths	5 Lengths	1 Heights
500 mm	980 mm	1280 mm
600	1080	1380
	1180	
	1280	
	1380	

Weight Bearing Capacity

Weight must be evenly distributed across the entire shelf.

		UNIT LENGTH 680 – 1280 MM	UNIT LENGTH 1380 – 1780 MM
SINGLE UNIT	Unit only	800 kg (TUV)	600 kg (TUV)
	Shelf only	200 (TUV)	150 (TUV)
	Unit with dunnage stand*	980	740
	Bottom shelf with dunnage stand*	380	290
CORNER UNIT*** with 2 dunnage stands required	Unit only	810	—
	Shelf only	180	—
	Bottom shelf with dunnage stands*	270	—
MOBILE UNIT	Unit only**	408	—



**TUV CERTIFICATION
WEIGHT BEARING CAPACITY**

*Dunnage Stands add stability and increase weight bearing capacity on bottom shelf only. Highly recommended for Starter Units 1380 mm and longer, all Corner Units, U-Shape Units and units specified for heavier loads. (See Overall Length Quick Reference Guide).

**Due to the weight bearing capacity of casters, maximum weight load on an entire Mobile Unit is 408 kg.

*** Corner connectors are for use only with shelves 680 – 1280 mm long.





HOT SAUCE

TANK SPICES

HONEY BEE'S

HOT SAUCE

HOT SAUCE

Teriyaki

DRESSINGS

CONDIMENTS

PREMIUM
SERIES

1700
mm
HEIGHT

V4PKG

4-SHELF VENTED UNITS

Starter units include 2 post kits and 4 shelf kits.
Units ship complete in 6 boxes.

Add-On units include 1 post kit and 4 shelf kits.
Units ship complete in 5 boxes.

Starter

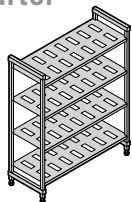

400 mm DEPTH

Add-On

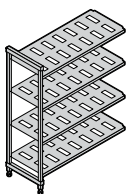

CODE	DIMENSIONS D x L x H
MPU4617V4PKG	400 x 680 x 1700 mm
MPU4717V4PKG	400 x 780 x 1700
MPU4817V4PKG	400 x 880 x 1700
MPU4917V4PKG	400 x 980 x 1700
MPU41017V4PKG	400 x 1080 x 1700
MPU41117V4PKG	400 x 1180 x 1700
MPU41217V4PKG	400 x 1280 x 1700
MPU41317V4PKG	400 x 1380 x 1700
MPU41417V4PKG	400 x 1480 x 1700
MPU41517V4PKG	400 x 1580 x 1700
MPU41617V4PKG	400 x 1680 x 1700
MPU41717V4PKG	400 x 1780 x 1700

CODE	DIMENSIONS D x L x H
MPA4617V4PKG	400 x 635 x 1700 mm
MPA4717V4PKG	400 x 735 x 1700
MPA4817V4PKG	400 x 835 x 1700
MPA4917V4PKG	400 x 935 x 1700
MPA41017V4PKG	400 x 1035 x 1700
MPA41117V4PKG	400 x 1135 x 1700
MPA41217V4PKG	400 x 1235 x 1700
MPA41317V4PKG	400 x 1335 x 1700
MPA41417V4PKG	400 x 1435 x 1700
MPA41517V4PKG	400 x 1535 x 1700
MPA41617V4PKG	400 x 1635 x 1700
MPA41717V4PKG	400 x 1735 x 1700

500 mm DEPTH

MPU5617V4PKG	500 x 680 x 1700 mm
MPU5717V4PKG	500 x 780 x 1700
MPU5817V4PKG	500 x 880 x 1700
MPU5917V4PKG	500 x 980 x 1700
MPU51017V4PKG	500 x 1080 x 1700
MPU51117V4PKG	500 x 1180 x 1700
MPU51217V4PKG	500 x 1280 x 1700
MPU51317V4PKG	500 x 1380 x 1700
MPU51417V4PKG	500 x 1480 x 1700
MPU51517V4PKG	500 x 1580 x 1700
MPU51617V4PKG	500 x 1680 x 1700
MPU51717V4PKG	500 x 1780 x 1700

MPA5617V4PKG	500 x 635 x 1700 mm
MPA5717V4PKG	500 x 735 x 1700
MPA5817V4PKG	500 x 835 x 1700
MPA5917V4PKG	500 x 935 x 1700
MPA51017V4PKG	500 x 1035 x 1700
MPA51117V4PKG	500 x 1135 x 1700
MPA51217V4PKG	500 x 1235 x 1700
MPA51317V4PKG	500 x 1335 x 1700
MPA51417V4PKG	500 x 1435 x 1700
MPA51517V4PKG	500 x 1535 x 1700
MPA51617V4PKG	500 x 1635 x 1700
MPA51717V4PKG	500 x 1735 x 1700

600 mm DEPTH

MPU6617V4PKG	600 x 680 x 1700 mm
MPU6717V4PKG	600 x 780 x 1700
MPU6817V4PKG	600 x 880 x 1700
MPU6917V4PKG	600 x 980 x 1700
MPU61017V4PKG	600 x 1080 x 1700
MPU61117V4PKG	600 x 1180 x 1700
MPU61217V4PKG	600 x 1280 x 1700
MPU61317V4PKG	600 x 1380 x 1700
MPU61417V4PKG	600 x 1480 x 1700
MPU61517V4PKG	600 x 1580 x 1700
MPU61617V4PKG	600 x 1680 x 1700
MPU61717V4PKG	600 x 1780 x 1700

MPA6617V4PKG	600 x 635 x 1700 mm
MPA6717V4PKG	600 x 735 x 1700
MPA6817V4PKG	600 x 835 x 1700
MPA6917V4PKG	600 x 935 x 1700
MPA61017V4PKG	600 x 1035 x 1700
MPA61117V4PKG	600 x 1135 x 1700
MPA61217V4PKG	600 x 1235 x 1700
MPA61317V4PKG	600 x 1335 x 1700
MPA61417V4PKG	600 x 1435 x 1700
MPA61517V4PKG	600 x 1535 x 1700
MPA61617V4PKG	600 x 1635 x 1700
MPA61717V4PKG	600 x 1735 x 1700

STOCK PRODUCTS & COLORS AVAILABLE IN OUR EUROPEAN WAREHOUSE

ALL SIZES: (490)

Color: Speckled White (490).

PREMIUM
SERIES

1800
mm
HEIGHT

V4PKG

4-SHELF VENTED UNITS

Starter units include 2 post kits and 4 shelf kits.
Units ship complete in 6 boxes.

Add-On units include 1 post kit and 4 shelf kits.
Units ship complete in 5 boxes.

Starter

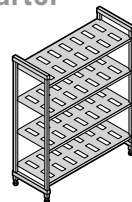

400 mm DEPTH

Add-On

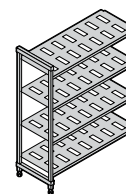

CODE	DIMENSIONS D x L x H
MPU4618V4PKG	400 x 680 x 1800 mm
MPU4718V4PKG	400 x 780 x 1800
MPU4818V4PKG	400 x 880 x 1800
MPU4918V4PKG	400 x 980 x 1800
MPU41018V4PKG	400 x 1080 x 1800
MPU41118V4PKG	400 x 1180 x 1800
MPU41218V4PKG	400 x 1280 x 1800
MPU41318V4PKG	400 x 1380 x 1800
MPU41418V4PKG	400 x 1480 x 1800
MPU41518V4PKG	400 x 1580 x 1800
MPU41618V4PKG	400 x 1680 x 1800
MPU41718V4PKG	400 x 1780 x 1800

CODE	DIMENSIONS D x L x H
MPA4618V4PKG	400 x 635 x 1800 mm
MPA4718V4PKG	400 x 735 x 1800
MPA4818V4PKG	400 x 835 x 1800
MPA4918V4PKG	400 x 935 x 1800
MPA41018V4PKG	400 x 1035 x 1800
MPA41118V4PKG	400 x 1135 x 1800
MPA41218V4PKG	400 x 1235 x 1800
MPA41318V4PKG	400 x 1335 x 1800
MPA41418V4PKG	400 x 1435 x 1800
MPA41518V4PKG	400 x 1535 x 1800
MPA41618V4PKG	400 x 1635 x 1800
MPA41718V4PKG	400 x 1735 x 1800

500 mm DEPTH

MPU5618V4PKG	500 x 680 x 1800 mm
MPU5718V4PKG	500 x 780 x 1800
MPU5818V4PKG	500 x 880 x 1800
MPU5918V4PKG	500 x 980 x 1800
MPU51018V4PKG	500 x 1080 x 1800
MPU51118V4PKG	500 x 1180 x 1800
MPU51218V4PKG	500 x 1280 x 1800
MPU51318V4PKG	500 x 1380 x 1800
MPU51418V4PKG	500 x 1480 x 1800
MPU51518V4PKG	500 x 1580 x 1800
MPU51618V4PKG	500 x 1680 x 1800
MPU51718V4PKG	500 x 1780 x 1800

MPA5618V4PKG	500 x 635 x 1800 mm
MPA5718V4PKG	500 x 735 x 1800
MPA5818V4PKG	500 x 835 x 1800
MPA5918V4PKG	500 x 935 x 1800
MPA51018V4PKG	500 x 1035 x 1800
MPA51118V4PKG	500 x 1135 x 1800
MPA51218V4PKG	500 x 1235 x 1800
MPA51318V4PKG	500 x 1335 x 1800
MPA51418V4PKG	500 x 1435 x 1800
MPA51518V4PKG	500 x 1535 x 1800
MPA51618V4PKG	500 x 1635 x 1800
MPA51718V4PKG	500 x 1735 x 1800

600 mm DEPTH

MPU6618V4PKG	600 x 680 x 1800 mm
MPU6718V4PKG	600 x 780 x 1800
MPU6818V4PKG	600 x 880 x 1800
MPU6918V4PKG	600 x 980 x 1800
MPU61018V4PKG	600 x 1080 x 1800
MPU61118V4PKG	600 x 1180 x 1800
MPU61218V4PKG	600 x 1280 x 1800
MPU61318V4PKG	600 x 1380 x 1800
MPU61418V4PKG	600 x 1480 x 1800
MPU61518V4PKG	600 x 1580 x 1800
MPU61618V4PKG	600 x 1680 x 1800
MPU61718V4PKG	600 x 1780 x 1800

MPA6618V4PKG	600 x 635 x 1800 mm
MPA6718V4PKG	600 x 735 x 1800
MPA6818V4PKG	600 x 835 x 1800
MPA6918V4PKG	600 x 935 x 1800
MPA61018V4PKG	600 x 1035 x 1800
MPA61118V4PKG	600 x 1135 x 1800
MPA61218V4PKG	600 x 1235 x 1800
MPA61318V4PKG	600 x 1335 x 1800
MPA61418V4PKG	600 x 1435 x 1800
MPA61518V4PKG	600 x 1535 x 1800
MPA61618V4PKG	600 x 1635 x 1800
MPA61718V4PKG	600 x 1735 x 1800

PREMIUM
SERIES

1800
mm
HEIGHT

V5PKG

5-SHELF VENTED UNITS

Starter units include 2 post kits and 5 shelf kits.
Units ship complete in 7 boxes.

Add-On units include 1 post kit and 5 shelf kits.
Units ship complete in 6 boxes.

Starter

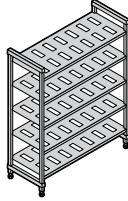

400 mm DEPTH

CODE	DIMENSIONS D x L x H
MPU4618V5PKG	400 x 680 x 1800 mm
MPU4718V5PKG	400 x 780 x 1800
MPU4818V5PKG	400 x 880 x 1800
MPU4918V5PKG	400 x 980 x 1800
MPU41018V5PKG	400 x 1080 x 1800
MPU41118V5PKG	400 x 1180 x 1800
MPU41218V5PKG	400 x 1280 x 1800
MPU41318V5PKG	400 x 1380 x 1800
MPU41418V5PKG	400 x 1480 x 1800
MPU41518V5PKG	400 x 1580 x 1800
MPU41618V5PKG	400 x 1680 x 1800
MPU41718V5PKG	400 x 1780 x 1800

500 mm DEPTH

MPU5618V5PKG	500 x 680 x 1800 mm
MPU5718V5PKG	500 x 780 x 1800
MPU5818V5PKG	500 x 880 x 1800
MPU5918V5PKG	500 x 980 x 1800
MPU51018V5PKG	500 x 1080 x 1800
MPU51118V5PKG	500 x 1180 x 1800
MPU51218V5PKG	500 x 1280 x 1800
MPU51318V5PKG	500 x 1380 x 1800
MPU51418V5PKG	500 x 1480 x 1800
MPU51518V5PKG	500 x 1580 x 1800
MPU51618V5PKG	500 x 1680 x 1800
MPU51718V5PKG	500 x 1780 x 1800

600 mm DEPTH

MPU6618V5PKG	600 x 680 x 1800 mm
MPU6718V5PKG	600 x 780 x 1800
MPU6818V5PKG	600 x 880 x 1800
MPU6918V5PKG	600 x 980 x 1800
MPU61018V5PKG	600 x 1080 x 1800
MPU61118V5PKG	600 x 1180 x 1800
MPU61218V5PKG	600 x 1280 x 1800
MPU61318V5PKG	600 x 1380 x 1800
MPU61418V5PKG	600 x 1480 x 1800
MPU61518V5PKG	600 x 1580 x 1800
MPU61618V5PKG	600 x 1680 x 1800
MPU61718V5PKG	600 x 1780 x 1800

Add-On

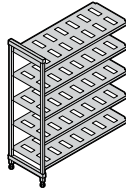

CODE	DIMENSIONS D x L x H
MPA4618V5PKG	400 x 635 x 1800 mm
MPA4718V5PKG	400 x 735 x 1800
MPA4818V5PKG	400 x 835 x 1800
MPA4918V5PKG	400 x 935 x 1800
MPA41018V5PKG	400 x 1035 x 1800
MPA41118V5PKG	400 x 1135 x 1800
MPA41218V5PKG	400 x 1235 x 1800
MPA41318V5PKG	400 x 1335 x 1800
MPA41418V5PKG	400 x 1435 x 1800
MPA41518V5PKG	400 x 1535 x 1800
MPA41618V5PKG	400 x 1635 x 1800
MPA41718V5PKG	400 x 1735 x 1800

MPA5618V5PKG	500 x 635 x 1800 mm
MPA5718V5PKG	500 x 735 x 1800
MPA5818V5PKG	500 x 835 x 1800
MPA5918V5PKG	500 x 935 x 1800
MPA51018V5PKG	500 x 1035 x 1800
MPA51118V5PKG	500 x 1135 x 1800
MPA51218V5PKG	500 x 1235 x 1800
MPA51318V5PKG	500 x 1335 x 1800
MPA51418V5PKG	500 x 1435 x 1800
MPA51518V5PKG	500 x 1535 x 1800
MPA51618V5PKG	500 x 1635 x 1800
MPA51718V5PKG	500 x 1735 x 1800

MPA6618V5PKG	600 x 635 x 1800 mm
MPA6718V5PKG	600 x 735 x 1800
MPA6818V5PKG	600 x 835 x 1800
MPA6918V5PKG	600 x 935 x 1800
MPA61018V5PKG	600 x 1035 x 1800
MPA61118V5PKG	600 x 1135 x 1800
MPA61218V5PKG	600 x 1235 x 1800
MPA61318V5PKG	600 x 1335 x 1800
MPA61418V5PKG	600 x 1435 x 1800
MPA61518V5PKG	600 x 1535 x 1800
MPA61618V5PKG	600 x 1635 x 1800
MPA61718V5PKG	600 x 1735 x 1800

PREMIUM
SERIES

1790
mm
HEIGHT

V4PKG

4-SHELF MOBILE UNITS

Mobile starter units include 2 mobile post kits, 4 shelf kits vented or solid and 4 swivel casters with total locking brake. Units ship complete in 6 boxes.

Vented

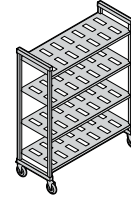

400 mm
DEPTH

DIMENSIONS D x L x H
400 x 980 x 1790 mm
400 x 1080 x 1790
400 x 1180 x 1790
400 x 1280 x 1790
400 x 1380 x 1790

CODE
MPMU4917V4PKG
MPMU41017V4PKG
MPMU41117V4PKG
MPMU41217V4PKG
MPMU41317V4PKG

Solid

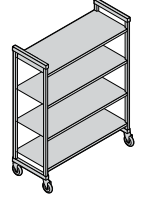

CODE
MPMU4917S4PKG
MPMU41017S4PKG
MPMU41117S4PKG
MPMU41217S4PKG
MPMU41317S4PKG

500 mm
DEPTH

500 x 980 x 1790 mm
500 x 1080 x 1790
500 x 1180 x 1790
500 x 1280 x 1790
500 x 1380 x 1790

MPMU5917V4PKG
MPMU51017V4PKG
MPMU51117V4PKG
MPMU51217V4PKG
MPMU51317V4PKG

MPMU5917S4PKG
MPMU51017S4PKG
MPMU51117S4PKG
MPMU51217S4PKG
MPMU51317S4PKG

600 mm
DEPTH

600 x 980 x 1790 mm
600 x 1080 x 1790
600 x 1180 x 1790
600 x 1280 x 1790
600 x 1380 x 1790

MPMU6917V4PKG
MPMU61017V4PKG
MPMU61117V4PKG
MPMU61217V4PKG
MPMU61317V4PKG

MPMU6917S4PKG
MPMU61017S4PKG
MPMU61117S4PKG
MPMU61217S4PKG
MPMU61317S4PKG

Color: Speckled White (490).

STOCK PRODUCTS & COLORS AVAILABLE IN OUR EUROPEAN WAREHOUSE

ALL SIZES: (490)

*Includes 127 mm casters.

CAMSHELVING® PREMIUM SERIES ACCESSORIES

Corner Connectors

Unique patented design ensures maximum shelf space utilization. Use 1 set per shelf to connect starter and add-on units in corners. Connect 4 or 5 intermediate shelves between 2 starter units (2 sets required per shelf). Available as a single set or 8 or 10 set packs.

**STOCK PRODUCTS & COLORS
AVAILABLE IN OUR EUROPEAN
WAREHOUSE**

ALL SIZES: (490)

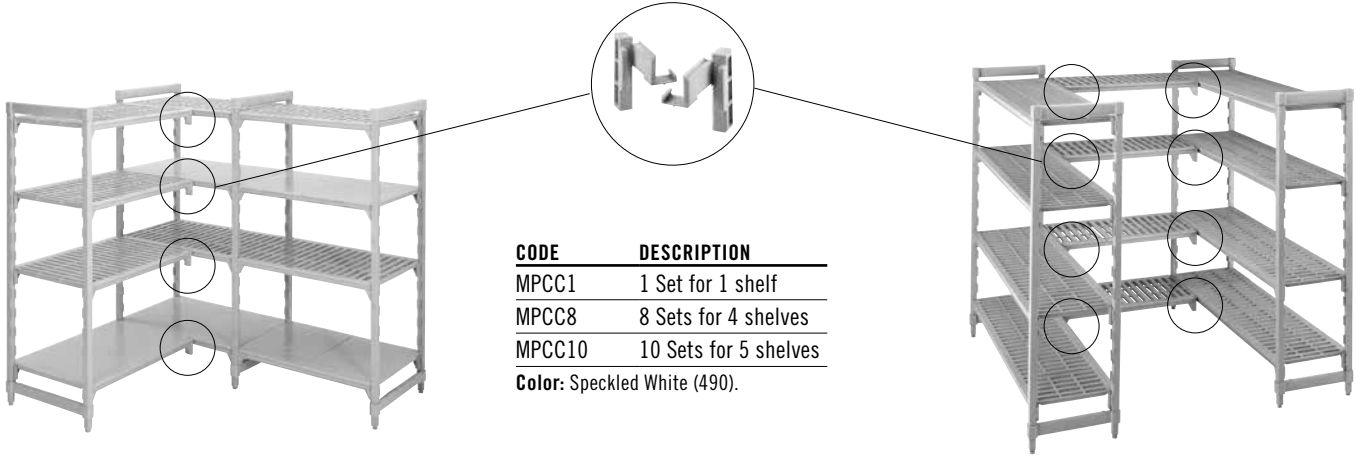

CODE	DESCRIPTION
MPCC1	1 Set for 1 shelf
MPCC8	8 Sets for 4 shelves
MPCC10	10 Sets for 5 shelves

Color: Speckled White (490).

Bottom Shelf Dunnage Stands

Increase weight bearing capacity on bottom shelf only. Add to any shelf length. Highly recommended for starter units 1375 mm and longer and all corner units, intermediate units and units specified for heavier load volume on and off bottom shelves.

CODE	DIMENSIONS D x H
Dunnage Stand – Low	
MPDS30H16	300 x 190 mm
MPDS40H16	400 x 190
MPDS50H16	500 x 190
MPDS60H16	600 x 190
Dunnage Stand – Tall	
MPDS30H30	300 x 289
MPDS40H30	400 x 289
MPDS50H30	500 x 289
MPDS60H30	600 x 289

Case Pack: 1
Color: Speckled White (490).

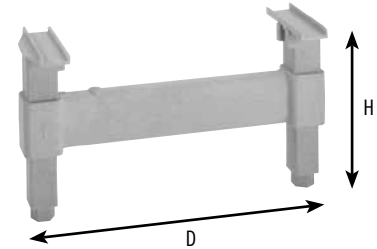

Bottom Shelf with Dunnage Stand

UNIT LENGTH	WEIGHT BEARING
Standard Unit	
610 to 1220 mm	545 kg
1375 to 1830	410
Corner Unit with 2 Dunnage Stands	
610 to 1220 mm	275

Shelf Traverses

Available in single or double packs. Use a single set to add an open shelf for divider bars or drying racks. Add single traverses onto back posts for extra support when placing rolling equipment under the first shelf.

LENGTH	SINGLE PACK CODE*	DOUBLE PACK CODE**
600 mm	MPTR60	—
700	MPTR70	—
800	MPTR80	—
900	MPTR90	MPTR902PK
1000	MPTR100	MPTR1002PK
1100	MPTR110	MPTR1102PK
1200	MPTR120	MPTR1202PK
1300	MPTR130	MPTR1302PK
1400	MPTR140	—
1500	MPTR150	—
1600	MPTR160	—
1700	MPTR170	—

*Case Pack: 1 **Case Pack: 2
Color: Speckled White (490).



**STOCK PRODUCTS & COLORS
AVAILABLE IN OUR EUROPEAN
WAREHOUSE**

ALL SIZES: (490)

HIGH DENSITY STORAGE FLOOR TRACK SYSTEM

Maximize storage capacity by creating storage aisles in all available space. This simple system is composed of stationary starter units anchored to a raised floor track system at both ends with high density mobile units installed in between. Easy to install track requires no drilling or gluing.

Increases Storage Capacity Up To

50%



High Density Mobile Units are available with factory assembled post kits, vented or solid shelves and high density casters and bumpers. Full track and extension kits ship complete with required hardware. Stationary Starter Units are required to anchor the system at both ends. Choose from a wide selection of sizes with 4 or 5 shelves to maximize storage space. (See Premium Series spec pages).

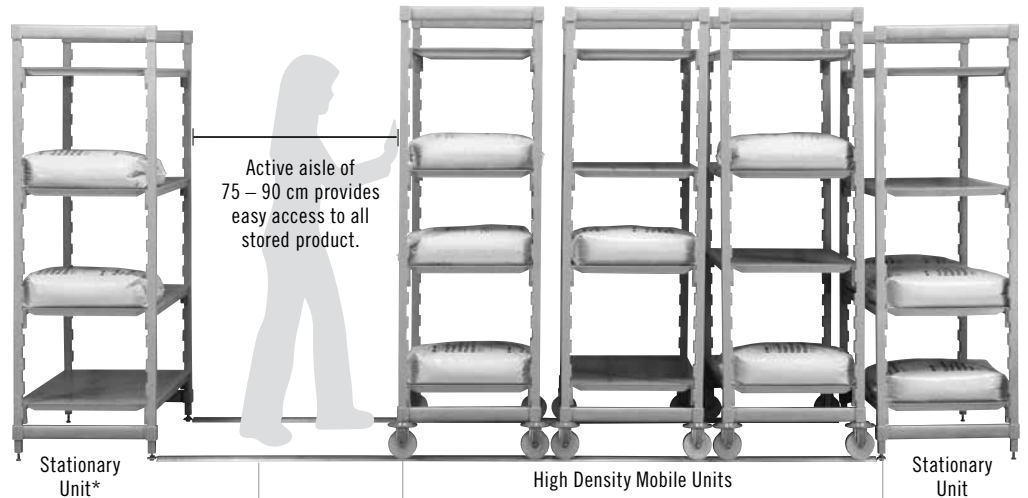

Only available from Cambro European Logistics (CEL), Germany and Cambro Özyay Turkey.

Raised Floor Track provides a smooth and level surface to easily roll mobile units. Raised track ensures dirt will not get trapped and is easy to clean. Aluminum track and stainless steel hardware are rust resistant.

*It is recommended to use a stationary unit for every 4,5 m of track to further stabilize the system.



Grooved casters roll easily and securely on raised track.



Raised track connects easily to the bottom of a stationary unit that works as a system anchor. No bolts, no glue or drilling into the floor are required. Easy and fast set up.

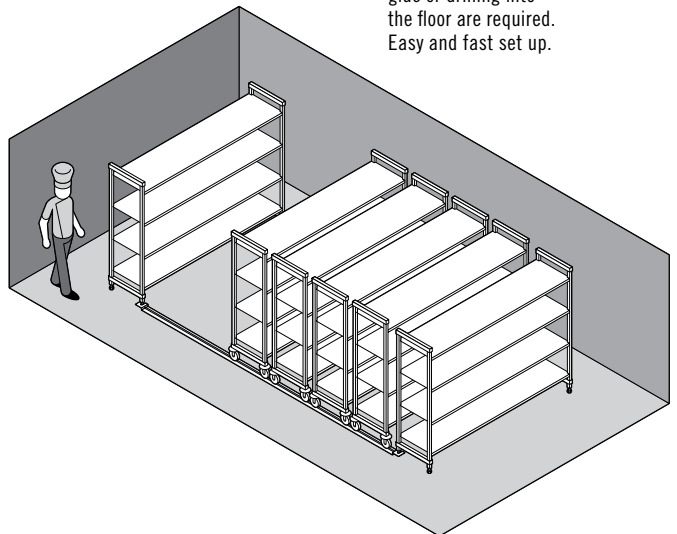
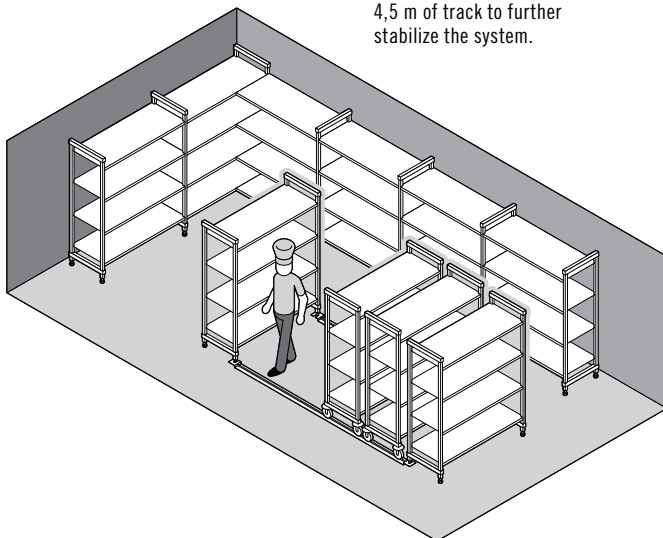



Golden Grill
CEREAL

CEREAL

CEREAL

GROUND
211

1184V 6/2 14-57

Phase

Phase

Phase

Phase

Phase

Phase

Phase

Phase

Phase

Phase

Phase

Phase

Phase

Phase

Phase

Phase

Phase

Phase

Phase

Phase

Phase

4-Shelf Vented High Density Mobile Starter Units

Units include 2 mobile post kits, 4 shelf kits, 4 high density casters and 4 high density bumpers. Ships in 6 boxes.

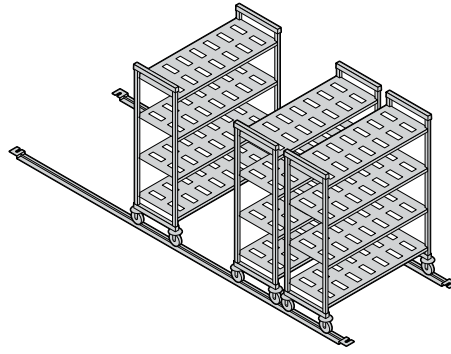

HEIGHT*	DEPTHS	LENGTHS
1	2	5
1790 mm	500 mm 600	980 mm 1080 1180 1280 1380

* Includes 127 mm casters.

4-Shelf Solid High Density Mobile Starter Units

Units include 2 mobile post kits, 4 shelf kits, 4 high density casters and 4 high density bumpers. Ships in 6 boxes.

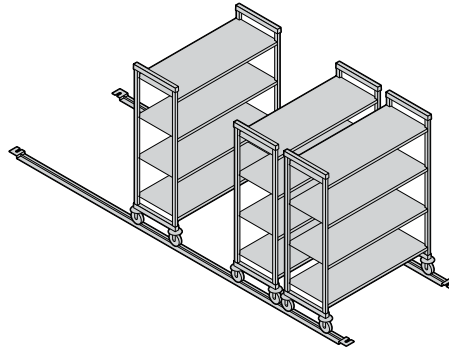

HEIGHT*	DEPTHS	LENGTHS
1	2	5
1790 mm	500 mm 600	980 mm 1080 1180 1280 1380

* Includes 127 mm casters.

Full Track and Extension Kits

Aluminum raised track kits and track extensions ship complete in 1 box. Each kit includes all stainless steel hardware necessary to complete a floor installation. Ships in 1 box.

It is highly recommended to install a stationary starter unit every 4,5 m of track to further stabilize the system.

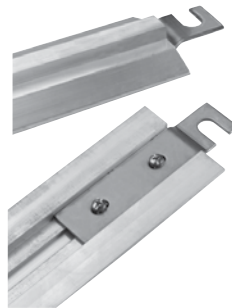

Full Track LENGTHS	Track Extension LENGTHS
3	3
3,05 m	1,38 m
3,66	1,53
4,42	1,83

CODE	DESCRIPTION	CASE PACK
Full Track Kit		
CSMHDTK10	3,05 m Track for 3 Mobile Units*	1
CSMHDTK12	3,66 m Track for 4 Mobile Units*	1
CSMHDTK145	4,42 m Track for 5 Mobile Units*	1
Track Extension Kit		
CSMHDTKE4	1,38 m Track Extension	1
CSMHDTKE5	1,53 m Track Extension	1
CSMHDTKE6	1,83 m Track Extension	1
Accessories		
CSHDF	Floor Fastener	4

Color: Silver (000). *Based on 600 mm deep mobile units.

STOCK PRODUCTS & COLORS AVAILABLE IN OUR EUROPEAN WAREHOUSE

ALL FLOOR TRACK KIT AND EXTENSION SIZES: (000)

PREMIUM
SERIES

V4

4-SHELF VENTED HIGH DENSITY MOBILE UNITS

S4

4-SHELF SOLID HIGH DENSITY MOBILE UNITS

Units include 2 mobile post kits, 4 shelf kits, 4 high density casters and 4 high density bumpers. Units ship complete in 6 boxes.

1790
mm
HEIGHT

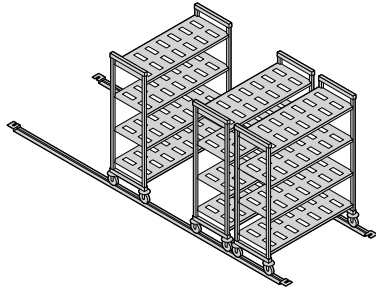

500 mm
DEPTH

CODE	DIMENSIONS D x L x H*
MPHU5917V4PKG	500 x 980 x 1790 mm
MPHU51017V4PKG	500 x 1080 x 1790
MPHU51117V4PKG	500 x 1180 x 1790
MPHU51217V4PKG	500 x 1280 x 1790
MPHU51317V4PKG	500 x 1380 x 1790

600 mm
DEPTH

MPHU6917V4PKG	600 x 980 x 1790 mm
MPHU61017V4PKG	600 x 1080 x 1790
MPHU61117V4PKG	600 x 1180 x 1790
MPHU61217V4PKG	600 x 1280 x 1790
MPHU61317V4PKG	600 x 1380 x 1790

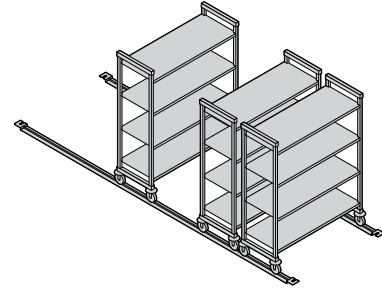

CODE	DIMENSIONS D x L x H*
MPHU5917S4PKG	500 x 980 x 1790 mm
MPHU51017S4PKG	500 x 1080 x 1790
MPHU51117S4PKG	500 x 1180 x 1790
MPHU51217S4PKG	500 x 1280 x 1790
MPHU51317S4PKG	500 x 1380 x 1790

MPHU6917S4PKG	600 x 980 x 1790 mm
MPHU61017S4PKG	600 x 1080 x 1790
MPHU61117S4PKG	600 x 1180 x 1790
MPHU61217S4PKG	600 x 1280 x 1790
MPHU61317S4PKG	600 x 1380 x 1790

Color: Speckled White (490). *Includes 127 mm casters.

**STOCK PRODUCTS & COLORS
AVAILABLE IN OUR EUROPEAN
WAREHOUSE**

ALL SIZES: (490)

High Density Caster with Donut Bumper

Grooved caster rolls easily and securely on raised track. Donut bumper protects mobile units from coming into direct contact with each other.

CODE	SIZE
MPMCHD	127 mm

Case Pack: 2 Color: Grey (000).

**STOCK PRODUCTS & COLORS
AVAILABLE IN OUR EUROPEAN
WAREHOUSE**

MPMCHD: (000)





WESTS Organic Unsweetened Milk

Triscuit ORIGINAL

Triscuit ORIGINAL

STREET LIGHT

STREET LIGHT

KIRKLAND SIGNATURE GREEN BEANS

KIRKLAND SIGNATURE GREEN BEANS

PREMIUM

PREMIUM

PREMIUM

PREMIUM

SYS

Triscuit

CAMSHELVING®

ELEMENTS® XTRA

series

STATIONARY | MOBILE | HIGH DENSITY | UNDERCOUNTER

- Posts and traverses made of a revolutionary, extremely strong composite material with a smooth, easy to clean surface. Posts now have notches on the inside only for installing traverse dovetails.
- Removable polypropylene shelf plates with permanent, molded-in Camguard®, an antimicrobial technology that inhibits the growth of mold, fungus, and bacteria.
- Sturdy reinforced threaded nylon foot adjusts easily to level units.
- Withstands storage temperatures from -38° to 88°C.
- Lifetime warranty against rust and corrosion.
- NEW patented post connector locks in place onto the wraparound collar wedge for solid, enhanced stability.
- NEW universal traverses can now be installed on both stationary or mobile units.
- NEW two piece, heavy-duty corner connectors featuring a "clasp" design offer zero loss of weight bearing in corners and greater weight bearing on middle shelves installed between units.



camguard

COMPONENT

ANTIMICROBIAL SHELF PLATES



Post Connectors, Corner Connectors, Floor Fastener, Wall Fastener, Identification Tags, Single Shelf Security Cage, Ultimate #10 Can Rack, and Shelf Divider Bars are not NSF Listed.

CAMSHELVING® ELEMENTS XTRA SERIES

STARTER UNITS

Ship complete in 1 box. Includes factory assembled post frames for quicker assembly.

Stationary

3 Depths	8 Lengths	3 Heights
460 mm	610 mm 1220 mm	1630 mm
540	765 1375	1830
610	915 1525	2140
	1070 1830	

Standard Mobile

3 Depths	5 Lengths	2 Heights
460 mm	915 mm 1375 mm	1784 mm
540	1070 1525	1987
610	1220	

Stationary Undercounter

1 Depth	2 Lengths	1 Height
460 mm	915 mm 1220	765 mm

High Density Mobile

3 Depths	5 Lengths	2 Heights
460 mm	915 mm 1375 mm	1784 mm
540	1070 1525	1987
610	1220	

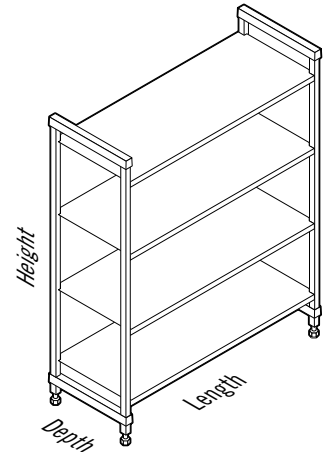

Weight Bearing Capacity

Weight must be evenly distributed across the entire shelf.

		UNIT LENGTH 610 – 1525 MM	UNIT LENGTH 1830 MM
SINGLE UNIT	Unit only	1090 kg	1090 kg
	Shelf only	365	275
	Unit with dunnage stand*	1270	1225
	Bottom shelf with dunnage stand*	545	410

		UNIT LENGTH 610 – 1525 MM	
CORNER UNIT With 2 Dunnage Stands required	Unit only	1090 kg	—
	Shelf only	365	—
	Bottom shelf with dunnage stands*	545	—

		UNIT LENGTH 610 – 1525 MM	
INTERMEDIATE SHELVES Shelves Installed Between 2 Units	Unit only	1090 kg	—
	Shelf only	365	—
	Bottom shelf with dunnage stands*	545	—
MOBILE UNIT	Unit only**	408	—

*Dunnage Stands add stability and increase weight bearing capacity on bottom shelf only. Highly recommended for Starter Units 1375 mm and longer, all Corner Units, U-Shape Units and units specified for heavier loads. (See Overall Length Quick Reference Guide).
 **Due to the weight bearing capacity of casters, maximum weight load on an entire Mobile Unit is 408 kg.
 *** Corner connectors are for use only with shelves 610 - 1525 mm long.



ELEMENTS
XTRA
SERIES

1630
mm
HEIGHT

V4 4-SHELF VENTED UNITS

Starter units include 2 factory assembled stationary post kits, stationary traverses, stationary traverse dovetails and shelf plates. Add-On units include 1 factory assembled stationary post kit, stationary traverses, stationary traverse dovetails and shelf plates. Units ship complete in 1 box.

Starter

Add-On

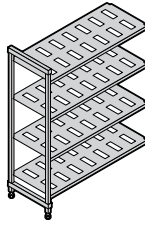
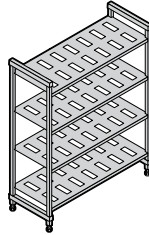

460 mm
DEPTH

DIMENSIONS
D x L x H

460 x 610 x 1630 mm
460 x 765 x 1630
460 x 915 x 1630
460 x 1070 x 1630
460 x 1220 x 1630
460 x 1375 x 1630
460 x 1525 x 1630
460 x 1830 x 1630

CODE

EXU182464V4
EXU183064V4
EXU183664V4
EXU184264V4
EXU184864V4
EXU185464V4
EXU186064V4
EXU187264V4

CODE

EXA182464V4
EXA183064V4
EXA183664V4
EXA184264V4
EXA184864V4
EXA185464V4
EXA186064V4
EXA187264V4

540 mm
DEPTH

540 x 610 x 1630 mm
540 x 765 x 1630
540 x 915 x 1630
540 x 1070 x 1630
540 x 1220 x 1630
540 x 1375 x 1630
540 x 1525 x 1630
540 x 1830 x 1630

EXU212464V4
EXU213064V4
EXU213664V4
EXU214264V4
EXU214864V4
EXU215464V4
EXU216064V4
EXU217264V4

EXA212464V4
EXA213064V4
EXA213664V4
EXA214264V4
EXA214864V4
EXA215464V4
EXA216064V4
EXA217264V4

610 mm
DEPTH

610 x 610 x 1630 mm
610 x 765 x 1630
610 x 915 x 1630
610 x 1070 x 1630
610 x 1220 x 1630
610 x 1375 x 1630
610 x 1525 x 1630
610 x 1830 x 1630

EXU242464V4
EXU243064V4
EXU243664V4
EXU244264V4
EXU244864V4
EXU245464V4
EXU246064V4
EXU247264V4

EXA242464V4
EXA243064V4
EXA243664V4
EXA244264V4
EXA244864V4
EXA245464V4
EXA246064V4
EXA247264V4

ELEMENTS
XTRA
SERIES

1830
mm
HEIGHT

V4 4-SHELF VENTED UNITS

Starter units include 2 factory assembled stationary post kits, stationary traverses, stationary traverse dovetails and shelf plates. Add-On units include 1 factory assembled stationary post kit, stationary traverses, stationary traverse dovetails and shelf plates. Units ship complete in 1 box.

Starter

Add-On

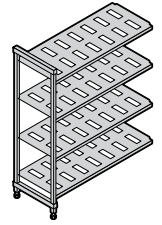
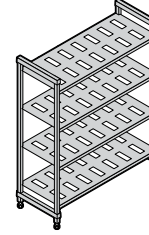

DIMENSIONS
D x L x H

460 x 610 x 1830 mm
460 x 765 x 1830
460 x 915 x 1830
460 x 1070 x 1830
460 x 1220 x 1830
460 x 1375 x 1830
460 x 1525 x 1830
460 x 1830 x 1830

CODE

EXU182472V4
EXU183072V4
EXU183672V4
EXU184272V4
EXU184872V4
EXU185472V4
EXU186072V4
EXU187272V4

CODE

EXA182472V4
EXA183072V4
EXA183672V4
EXA184272V4
EXA184872V4
EXA185472V4
EXA186072V4
EXA187272V4

540 x 610 x 1830 mm
540 x 765 x 1830
540 x 915 x 1830
540 x 1070 x 1830
540 x 1220 x 1830
540 x 1375 x 1830
540 x 1525 x 1830
540 x 1830 x 1830

EXU212472V4
EXU213072V4
EXU213672V4
EXU214272V4
EXU214872V4
EXU215472V4
EXU216072V4
EXU217272V4

EXA212472V4
EXA213072V4
EXA213672V4
EXA214272V4
EXA214872V4
EXA215472V4
EXA216072V4
EXA217272V4

610 x 610 x 1830 mm
610 x 765 x 1830
610 x 915 x 1830
610 x 1070 x 1830
610 x 1220 x 1830
610 x 1375 x 1830
610 x 1525 x 1830
610 x 1830 x 1830

EXU242472V4
EXU243072V4
EXU243672V4
EXU244272V4
EXU244872V4
EXU245472V4
EXU246072V4
EXU247272V4

EXA242472V4
EXA243072V4
EXA243672V4
EXA244272V4
EXA244872V4
EXA245472V4
EXA246072V4
EXA247272V4

Color: Brushed Graphite (580).

ELEMENTS
XTRA
SERIES

2140
mm
HEIGHT

V5 5-SHELF VENTED UNITS

Starter units include 2 factory assembled stationary post kits, stationary traverses, stationary traverse dovetails and shelf plates. Add-On units include 1 factory assembled stationary post kit, stationary traverses, stationary traverse dovetails and shelf plates. Units ship complete in 1 box.

Starter

Add-On

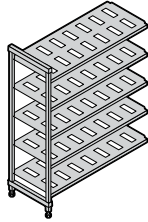
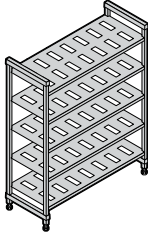

460 mm
DEPTH

DIMENSIONS
D x L x H

460 x 610 x 2140 mm
460 x 765 x 2140
460 x 915 x 2140
460 x 1070 x 2140
460 x 1220 x 2140
460 x 1375 x 2140
460 x 1525 x 2140
460 x 1830 x 2140

CODE

EXU182484V5
EXU183084V5
EXU183684V5
EXU184284V5
EXU184884V5
EXU185484V5
EXU186084V5
EXU187284V5

CODE

EXA182484V5
EXA183084V5
EXA183684V5
EXA184284V5
EXA184884V5
EXA185484V5
EXA186084V5
EXA187284V5

540 mm
DEPTH

540 x 610 x 2140 mm
540 x 765 x 2140
540 x 915 x 2140
540 x 1070 x 2140
540 x 1220 x 2140
540 x 1375 x 2140
540 x 1525 x 2140
540 x 1830 x 2140

EXU212484V5
EXU213084V5
EXU213684V5
EXU214284V5
EXU214884V5
EXU215484V5
EXU216084V5
EXU217284V5

EXA212484V5
EXA213084V5
EXA213684V5
EXA214284V5
EXA214884V5
EXA215484V5
EXA216084V5
EXA217284V5

610 mm
DEPTH

610 x 610 x 2140 mm
610 x 765 x 2140
610 x 915 x 2140
610 x 1070 x 2140
610 x 1220 x 2140
610 x 1375 x 2140
610 x 1525 x 2140
610 x 1830 x 2140

EXU242484V5
EXU243084V5
EXU243684V5
EXU244284V5
EXU244884V5
EXU245484V5
EXU246084V5
EXU247284V5

EXA242484V5
EXA243084V5
EXA243684V5
EXA244284V5
EXA244884V5
EXA245484V5
EXA246084V5
EXA247284V5

ELEMENTS
XTRA
SERIES

V4 4-SHELF VENTED MOBILE UNITS

Mobile units include 2 factory assembled mobile post kits, mobile traverses, mobile traverse dovetails, shelf plates, and 4 premium swivel casters with total locking brake. Units ship complete in 1 box.

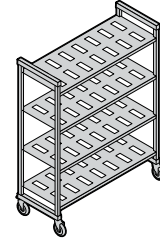

* Includes
127 mm
casters.

1778
mm
HEIGHT

460 mm
DEPTH

540 mm
DEPTH

610 mm
DEPTH

1980
mm
HEIGHT

460 mm
DEPTH

540 mm
DEPTH

610 mm
DEPTH

CODE	DIMENSIONS D x L x H*
EXMU183670V4	460 x 915 x 1778 mm
EXMU184270V4	460 x 1070 x 1778
EXMU184870V4	460 x 1220 x 1778
EXMU185470V4	460 x 1375 x 1778
EXMU186070V4	460 x 1525 x 1778

EXMU213670V4	540 x 915 x 1778 mm
EXMU214270V4	540 x 1070 x 1778
EXMU214870V4	540 x 1220 x 1778
EXMU215470V4	540 x 1375 x 1778
EXMU216070V4	540 x 1525 x 1778

EXMU243670V4	610 x 915 x 1778 mm
EXMU244270V4	610 x 1070 x 1778
EXMU244870V4	610 x 1220 x 1778
EXMU245470V4	610 x 1375 x 1778
EXMU246070V4	610 x 1525 x 1778

CODE	DIMENSIONS D x L x H*
EXMU183678V4	460 x 915 x 1980 mm
EXMU184278V4	460 x 1070 x 1980
EXMU184878V4	460 x 1220 x 1980
EXMU185478V4	460 x 1375 x 1980
EXMU186078V4	460 x 1525 x 1980

EXMU213678V4	540 x 915 x 1980 mm
EXMU214278V4	540 x 1070 x 1980
EXMU214878V4	540 x 1220 x 1980
EXMU215478V4	540 x 1375 x 1980
EXMU216078V4	540 x 1525 x 1980

EXMU243678V4	610 x 915 x 1980 mm
EXMU244278V4	610 x 1070 x 1980
EXMU244878V4	610 x 1220 x 1980
EXMU245478V4	610 x 1375 x 1980
EXMU246078V4	610 x 1525 x 1980

Color: Brushed Graphite (580).

CAMSHELVING® ELEMENTS XTRA SERIES

Corner Connectors

Unique clasp design ensures maximum shelf space utilization without loss of weight bearing in corners and increased weight bearing on middle shelves between units. Use 1 set per shelf to connect starter and add-on units in corners. Connect 4 or 5 intermediate shelves between 2 starter units (2 sets required per shelf).

CODE	DESCRIPTION
EXCC1	1 Set for 1 shelf
EXCC4	4 Sets for 4 shelves
EXCC5	5 Sets for 5 shelves

Color: Speckled Gray (480).



Bottom Shelf Dunnage Stands

Increase weight bearing capacity on bottom shelf only. Add to any shelf length. Highly recommended for starter units 1375 mm and longer and all corner units, intermediate units and units specified for heavier load volume on and off bottom shelves.

Bottom Shelf with Dunnage Stand

UNIT LENGTH	WEIGHT BEARING
Standard Unit	
610 to 1220 mm	545 kg
1375 to 1830	410
Corner Unit with 2 Dunnage Stands	
610 to 1525	545

CODE	DIMENSIONS D x H
Dunnage Stand – Low (bottom shelf installed on lowest set of open post locations for dovetails)	
CSDS18H6	460 x 165 mm
CSDS21H6	540 x 165
CSDS24H6	610 x 165

Dunnage Stand – Tall (bottom shelf installed up on 2nd set of open post locations for dovetails)	
CSDS18H10	460 x 267
CSDS21H10	540 x 267
CSDS24H10	610 x 267

Case Pack: 1 Color: Speckled Gray (480).

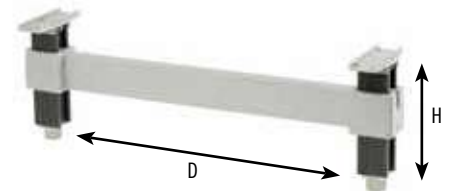

Shelf Traverses

Available in single or double packs. Use two traverses to add an open shelf for divider bars or drying cradles. Add one traverse onto back posts of a stationary unit for extra support when placing rolling equipment under the first shelf. Traverse dovetails included.

LENGTH	SINGLE PACK CODE*	DOUBLE PACK CODE**
610 mm	EXTR24	EXTR242PK
765	EXTR30	EXTR302PK
915	EXTR36	EXTR362PK
1070	EXTR42	EXTR422PK
1220	EXTR48	EXTR482PK
1375	EXTR54	EXTR542PK
1525	EXTR60	EXTR602PK
1830	EXTR72	—

*Case Pack: 1 **Case Pack: 2
Color: Speckled Gray (480).



Elements XTRA Shelf Traverses covered by U.S. Patent D 989,612 S, 11,812,847 B2, 11,697,037 B2.

CAMSHELVING® ELEMENTS XTRA SERIES

High Density Full Track and Track Extension Kits

Each kit ships complete in 1 box with aluminum raised track rails and stainless steel hardware required to complete installation.

CODE	DESCRIPTION	CASE PACK
Full Track Kits		
CSMHDTK10	3,05 m Track for 3 Mobile Units*	1
CSMHDTK12	3,66 m Track for 4 Mobile Units*	1
CSMHDTK145	4,42 m Track for 5 Mobile Units*	1

Color: Silver (000). *Based on 610 mm deep mobile units.

Full Track Kits include: Track rails, rail joiners, end plates, 8 stainless steel leveling feet (for stationary units) and required hardware.

CODE	DESCRIPTION	CASE PACK
Track Extension Kits		
CSMHDTKE4	1,38 m Track Extension	1
CSMHDTKE5	1,53 m Track Extension	1
CSMHDTKE6	1,83 m Track Extension	1

Color: Silver (000). **Extension Track Kits include:** Track rails (1 set), 2 rail joiners, and required hardware.

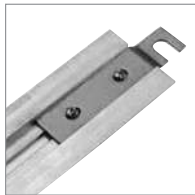

Track rail (underside) shown with end plate installed.

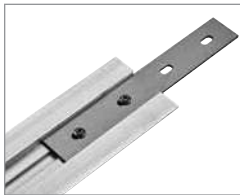

Track rail (underside) shown with track rail joiner partially installed

It is highly recommended to install a stationary starter unit every 4,5 m of track to further stabilize the system.

High Density Floor Fastener

Secure stationary unit front posts with rails directly to the floor for added safety and stability where required. Made of stainless steel. Bolts not included.

CODE	DIMENSION D x L x H
CSHDFE	35 x 108 x 13 mm

Case Pack: 4 **Color:** Silver (000).

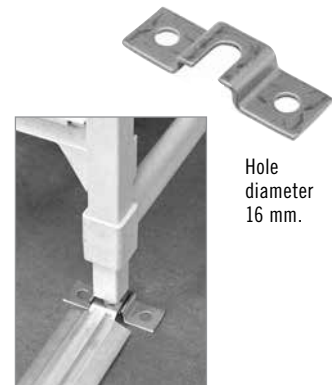

Hole diameter 16 mm.

High Density Caster With Donut Bumper



CODE	SIZE
CPMCHD	127 mm

Case Pack: 2 **Color:** Gray (000).





CAMSHELVING®

BASICS PLUS

series

STATIONARY

- Posts and traverses made of a revolutionary, extremely strong, composite material with a smooth, easy to clean surface.
- Attach left and right traverse dovetails to each post to secure shelf traverses every 10,2 cm.
- Removable polypropylene shelf plates with permanent, molded-in Camguard®, an antimicrobial technology that inhibits the growth of mold, fungus, and bacteria.
- Sturdy reinforced threaded nylon foot adjusts easily to level units.
- Withstands storage temperatures from -38° to 88°C.
- Lifetime warranty against rust and corrosion.



camguard

ANTIMICROBIAL SHELF PLATES



HACCP



CdF



**Store
Safe**

Post Connectors, Corner Connectors, Floor Fastener, Wall Fastener, Shelf Rails, Single Shelf Security Cage, Shelf Divider Panels and Identification Tags are not NSF listed.

CAMSHELVING® BASICS PLUS SERIES

STARTER UNITS

Ship complete in 1 box. Includes factory assembled post frames for quicker assembly.

Stationary

3 Depths	6 Lengths		3 Heights
460 mm	765 mm	1220 mm	1630 mm
540	915	1375	1830
610	1070	1525	2140

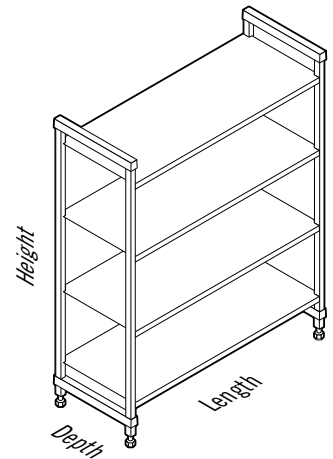

Weight Bearing Capacity

Weight must be evenly distributed across the entire shelf.

		UNIT LENGTH 765 – 1220 MM	UNIT LENGTH 1375 – 1830 MM
SINGLE UNIT	Unit only	800 kg (TUV)	800 kg (TUV)
	Shelf only	190 (TUV)	180 (TUV)
	Unit with dunnage stand*	885	880
	Bottom shelf with dunnage stand*	275	260
CORNER UNIT** with 2 dunnage stands required	Unit only	590	—
	Shelf only	130	—
	Bottom shelf with dunnage stands*	200	—



**TUV CERTIFICATION
WEIGHT BEARING CAPACITY**

*Dunnage Stands add stability and increase weight bearing capacity on bottom shelf only. Highly recommended for Starter Units 1375 mm and longer, all Corner Units, U-Shape Units and units specified for heavier loads. (See Overall Length Quick Reference Guide).

** Corner connectors are for use only with shelves 765 – 1220 mm long.





BASICS
PLUS
SERIES

1630
mm
HEIGHT

V4 4-SHELF VENTED UNITS

Starter units include 2 factory assembled post kits and shelves. Add-on units include 1 factory assembled post kit and shelves. Units ship complete in 1 box.

Starter

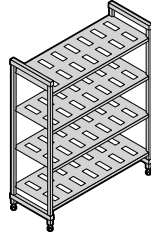

Add-On

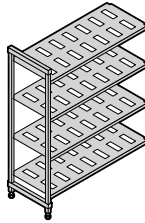

360 mm DEPTH

CODE	DIMENSIONS D x L x H
CBU143064V4	360 x 765 x 1630 mm
CBU143664V4	360 x 915 x 1630
CBU144264V4	360 x 1070 x 1630
CBU144864V4	360 x 1220 x 1630

CODE	DIMENSIONS D x L x H
CBA143064V4	360 x 718 x 1630 mm
CBA143664V4	360 x 870 x 1630
CBA144264V4	360 x 1023 x 1630
CBA144864V4	360 x 1175 x 1630

460 mm DEPTH

CBU183064V4	460 x 765 x 1630 mm
CBU183664V4	460 x 915 x 1630
CBU184264V4	460 x 1070 x 1630
CBU184864V4	460 x 1220 x 1630
CBU185464V4	460 x 1375 x 1630
CBU186064V4	460 x 1525 x 1630
CBU187264V4	460 x 1830 x 1630

CBA183064V4	460 x 718 x 1630 mm
CBA183664V4	460 x 870 x 1630
CBA184264V4	460 x 1023 x 1630
CBA184864V4	460 x 1175 x 1630
CBA185464V4	460 x 1328 x 1630
CBA186064V4	460 x 1480 x 1630
CBA187264V4	460 x 1785 x 1630

540 mm DEPTH

CBU213064V4	540 x 765 x 1630 mm
CBU213664V4	540 x 915 x 1630
CBU214264V4	540 x 1070 x 1630
CBU214864V4	540 x 1220 x 1630
CBU215464V4	540 x 1375 x 1630
CBU216064V4	540 x 1525 x 1630
CBU217264V4	540 x 1830 x 1630

CBA213064V4	540 x 718 x 1630 mm
CBA213664V4	540 x 870 x 1630
CBA214264V4	540 x 1023 x 1630
CBA214864V4	540 x 1175 x 1630
CBA215464V4	540 x 1328 x 1630
CBA216064V4	540 x 1480 x 1630
CBA217264V4	540 x 1785 x 1630

610 mm DEPTH

CBU243064V4	610 x 765 x 1630 mm
CBU243664V4	610 x 915 x 1630
CBU244264V4	610 x 1070 x 1630
CBU244864V4	610 x 1220 x 1630
CBU245464V4	610 x 1375 x 1630
CBU246064V4	610 x 1525 x 1630
CBU247264V4	610 x 1830 x 1630

CBA243064V4	610 x 718 x 1630 mm
CBA243664V4	610 x 870 x 1630
CBA244264V4	610 x 1023 x 1630
CBA244864V4	610 x 1175 x 1630
CBA245464V4	610 x 1328 x 1630
CBA246064V4	610 x 1480 x 1630
CBA247264V4	610 x 1785 x 1630

Color: Brushed Graphite (580).

STOCK PRODUCTS & COLORS AVAILABLE IN OUR EUROPEAN WAREHOUSE

ALL SIZES: (580)

BASICS
PLUS
SERIES

1830
mm
HEIGHT

V4 4-SHELF VENTED UNITS

Starter units include 2 factory assembled post kits and shelves. Add-on units include 1 factory assembled post kit and shelves. Units ship complete in 1 box.

Starter

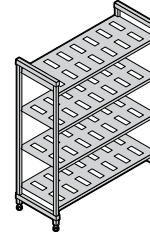

Add-On

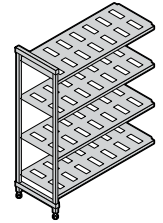

360 mm DEPTH

CODE	DIMENSIONS D x L x H
CBU143072V4	360 x 765 x 1830 mm
CBU143672V4	360 x 915 x 1830
CBU144272V4	360 x 1070 x 1830
CBU144872V4	360 x 1220 x 1830

CODE	DIMENSIONS D x L x H
CBA143072V4	360 x 718 x 1830 mm
CBA143672V4	360 x 870 x 1830
CBA144272V4	360 x 1023 x 1830
CBA144872V4	360 x 1175 x 1830

460 mm DEPTH

CBU183072V4	460 x 765 x 1830 mm
CBU183672V4	460 x 915 x 1830
CBU184272V4	460 x 1070 x 1830
CBU184872V4	460 x 1220 x 1830
CBU185472V4	460 x 1375 x 1830
CBU186072V4	460 x 1525 x 1830
CBU187272V4	460 x 1830 x 1830

CBA183072V4	460 x 718 x 1830 mm
CBA183672V4	460 x 870 x 1830
CBA184272V4	460 x 1023 x 1830
CBA184872V4	460 x 1175 x 1830
CBA185472V4	460 x 1328 x 1830
CBA186072V4	460 x 1480 x 1830
CBA187272V4	460 x 1785 x 1830

540 mm DEPTH

CBU213072V4	540 x 765 x 1830 mm
CBU213672V4	540 x 915 x 1830
CBU214272V4	540 x 1070 x 1830
CBU214872V4	540 x 1220 x 1830
CBU215472V4	540 x 1375 x 1830
CBU216072V4	540 x 1525 x 1830
CBU217272V4	540 x 1830 x 1830

CBA213072V4	540 x 718 x 1830 mm
CBA213672V4	540 x 870 x 1830
CBA214272V4	540 x 1023 x 1830
CBA214872V4	540 x 1175 x 1830
CBA215472V4	540 x 1328 x 1830
CBA216072V4	540 x 1480 x 1830
CBA217272V4	540 x 1785 x 1830

610 mm DEPTH

CBU243072V4	610 x 765 x 1830 mm
CBU243672V4	610 x 915 x 1830
CBU244272V4	610 x 1070 x 1830
CBU244872V4	610 x 1220 x 1830
CBU245472V4	610 x 1375 x 1830
CBU246072V4	610 x 1525 x 1830
CBU247272V4	610 x 1830 x 1830

CBA243072V4	610 x 718 x 1830 mm
CBA243672V4	610 x 870 x 1830
CBA244272V4	610 x 1023 x 1830
CBA244872V4	610 x 1175 x 1830
CBA245472V4	610 x 1328 x 1830
CBA246072V4	610 x 1480 x 1830
CBA247272V4	610 x 1785 x 1830



BASICS
PLUS
SERIES
2140
mm
HEIGHT

V5

5-SHELF VENTED UNITS

Starter units include 2 factory assembled post kits and shelves. Add on units include 1 factory assembled post kit and shelves. Units ship complete in 1 box.

Starter

Add-On

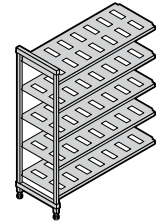
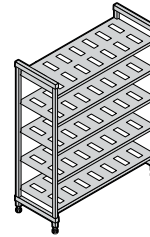

460 mm DEPTH

CODE	DIMENSIONS D x L x H
CBU183084V5	460 x 765 x 2140 mm
CBU183684V5	460 x 915 x 2140
CBU184284V5	460 x 1070 x 2140
CBU184884V5	460 x 1220 x 2140
CBU185484V5	460 x 1375 x 2140
CBU186084V5	460 x 1525 x 2140

CODE	DIMENSIONS D x L x H
CBA183084V5	460 x 718 x 2140 mm
CBA183684V5	460 x 870 x 2140
CBA184284V5	460 x 1023 x 2140
CBA184884V5	460 x 1175 x 2140
CBA185484V5	460 x 1328 x 2140
CBA186084V5	460 x 1480 x 2140

540 mm DEPTH

CBU213084V5	540 x 765 x 2140 mm
CBU213684V5	540 x 915 x 2140
CBU214284V5	540 x 1070 x 2140
CBU214884V5	540 x 1220 x 2140
CBU215484V5	540 x 1375 x 2140
CBU216084V5	540 x 1525 x 2140

CBA213084V5	540 x 718 x 2140 mm
CBA213684V5	540 x 870 x 2140
CBA214284V5	540 x 1023 x 2140
CBA214884V5	540 x 1175 x 2140
CBA215484V5	540 x 1328 x 2140
CBA216084V5	540 x 1480 x 2140

610 mm DEPTH

CBU243084V5	610 x 765 x 2140 mm
CBU243684V5	610 x 915 x 2140
CBU244284V5	610 x 1070 x 2140
CBU244884V5	610 x 1220 x 2140
CBU245484V5	610 x 1375 x 2140
CBU246084V5	610 x 1525 x 2140

CBA243084V5	610 x 718 x 2140 mm
CBA243684V5	610 x 870 x 2140
CBA244284V5	610 x 1023 x 2140
CBA244884V5	610 x 1175 x 2140
CBA245484V5	610 x 1328 x 2140
CBA246084V5	610 x 1480 x 2140

Color: Brushed Graphite (580).

**STOCK PRODUCTS & COLORS AVAILABLE
IN OUR EUROPEAN WAREHOUSE**

ALL SIZES: (580)

CAMSHELVING® BASICS PLUS SERIES

Corner Connectors

Unique patented design ensures maximum shelf space utilization. Use 1 set per shelf to connect starter and add-on units in corners. Connect 4 or 5 intermediate shelves between 2 starter units (2 sets required per shelf). Available as a single set or 8 or 10 set packs.

**STOCK PRODUCTS & COLORS
AVAILABLE IN OUR EUROPEAN
WAREHOUSE**

ALL SIZES: (580)

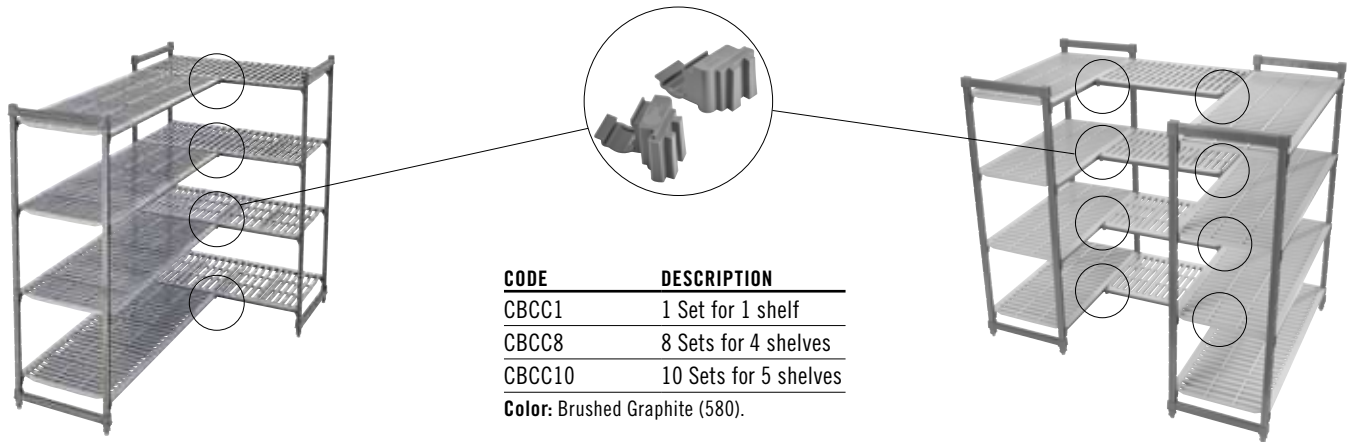

CODE	DESCRIPTION
CBCC1	1 Set for 1 shelf
CBCC8	8 Sets for 4 shelves
CBCC10	10 Sets for 5 shelves

Color: Brushed Graphite (580).

Bottom Shelf Dunnage Stands

Increase weight bearing capacity on bottom shelf only. Add to any shelf length. Highly recommended for starter units 1375 mm and longer and all corner units, intermediate units and units specified for heavier load volume on and off bottom shelves.

**STOCK PRODUCTS & COLORS
AVAILABLE IN OUR EUROPEAN
WAREHOUSE**

CBDS18H6, CBDS21H6, CBDS24H6: (151)



CODE	DIMENSIONS D x H
Dunnage Stand – Low	
CBDS14H6	360 x 171 mm
CBDS18H6	460 x 171
CBDS21H6	540 x 171
CBDS24H6	610 x 171
Dunnage Stand – Tall	
CBDS14H10	360 x 273 mm
CBDS18H10	460 x 273
CBDS21H10	540 x 273
CBDS24H10	610 x 273

Case Pack: 1
Color: Brushed Graphite (580).

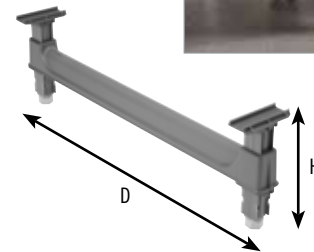

Shelf Traverses

Available in single or double packs. Use a single set to add an open shelf for divider bars or drying racks. Add single traverses onto back posts for extra support when placing rolling equipment under the first shelf. Traverse dovetails included.

LENGTH	SINGLE PACK CODE*	DOUBLE PACK CODE**
765 mm	CBTR30	CBTR302PK
915	CBTR36	CBTR362PK
1070	CBTR42	CBTR422PK
1220	CBTR48	CBTR482PK
1375	CBTR54	CBTR542PK
1525	CBTR60	CBTR602PK
1830	CBTR72	CBTR722PK

*Case Pack: 1 **Case Pack: 2
Color: Brushed Graphite (580).

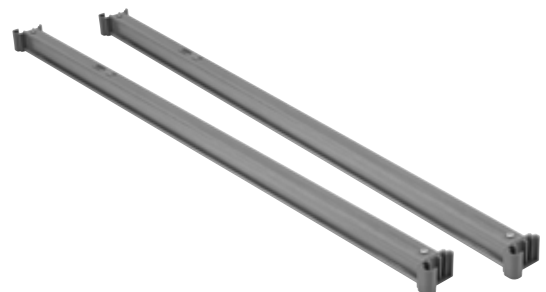

CAMSHELVING® ACCESSORIES

Identification Tags

Clip onto shelf traverses to clearly identify stored product. Made of highly durable plastic with a clear slide in front panel. 14 labels included: 12 color-coded, pre-printed and 2 blank.

CODE	DESCRIPTION	DIMENSION L x H
Premium and Elements XTRA Series		
CSID6	152 mm ID Tag	152 x 25 mm
CSID3	76 mm ID Tag	76 x 25
Basics Plus Series		
CBID6	152 mm ID Tag	152 x 25
Case Pack: 12		
Color: White / Clear.		



STOCK PRODUCTS & COLORS AVAILABLE IN OUR EUROPEAN WAREHOUSE
CSID6: (000)



Wall Fastener

Use to secure stationary shelving unit to a wall for added safety and stability where required. Made of stainless steel. Screws not included.

CODE	DIMENSION D x L x H
CSWF	73 x 238 x 48 mm
Case Pack: 4 Color: Silver (000).	



Hole diameter 1,11 cm.

STOCK PRODUCTS & COLORS AVAILABLE IN OUR EUROPEAN WAREHOUSE
CSWF: (000)



Floor Fastener

Secure stationary unit posts directly to the floor for added safety and stability where required. Made of stainless steel. Bolts not included.

CODE	DIMENSION D x L x H
Premium, Elements XTRA & Basics Plus Series	
CSFF	38 x 165 x 89 mm
Premium Series High Density	
CSHDF	35 x 108 x 13
CSFF Case Pack: 2	
CSHDF Case Pack: 4	
Color: Silver (000).	



Hole diameter 1,43 cm.



Premium Caster

Ideal in all areas of storage, especially coolers, freezers and/or wet areas. Made of highly durable, non-corrosive plastic with a 127 mm swivel, non-marking thermoplastic rubber wheel. Total locking brake locks both swivel motion and the wheel.

CODE	SIZE
Premium Series with Bumper	
MPMCWB	127 mm
Elements XTRA Series	
EMCWB	127 mm
Case Pack: 2 Color: Grey (000).	

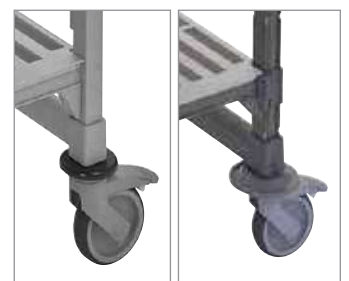
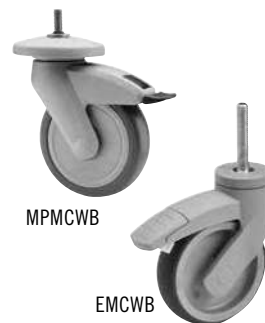

STOCK PRODUCTS & COLORS AVAILABLE IN OUR EUROPEAN WAREHOUSE
MPMCWB: (000)

Donut Bumper

Offers added protection during transport and when maneuvering mobile units into place against walls or alongside other units for storage.

CODE	DIAMETER
CSMHDD	127 mm
Case Pack: 4 Color: Grey (000).	

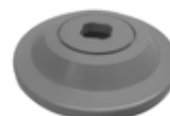

CAMSHELVING® ACCESSORIES

Shelf Divider

Stack and separate items stored on shelves. Made of highly durable ABS plastic. Installs directly onto solid or vented shelves. Easily removable for relocating or washing. Use with Shelf Rails to prevent contents from falling off shelves.

CODE	DIMENSION D x H
CSSD188	460 x 203 mm
CSSD218	540 x 203
CSSD248	610 x 203

Case Pack: 1 Color: Soft Grey (151).



STOCK PRODUCTS & COLORS AVAILABLE IN OUR EUROPEAN WAREHOUSE

ALL SIZES: (151)



Shelf Rails

Use to prevent contents from falling off shelves. Protect individual sides or ends or wrap a full shelf. Rods are made from a strong composite material that is highly durable and will never rust or corrode.

Fits Premium Shelving Units 680 to 1780 mm wide and 300 to 600 mm deep, or Elements XTRA and Basics Plus Unit 765 to 1830 mm wide and 360 to 610 mm deep.

Full or three-quarter shelf kits help to streamline installations and significantly reduces carton waste.

Full Shelf Rail Kits

PREMIUM CODE	DIMENSION D x L	ELEMENTS XTRA CODE	BASICS PLUS CODE	DIMENSION D x L
Full Shelf Rail Kits (2 sides, 2 ends)				
MPR600900	600 x 900 mm	ESR2436	CBR2436	610 x 910 mm
MPR6001000	600 x 1000	ESR2442	CBR2442	610 x 1070
MPR6001100	600 x 1100	ESR2448	CBR2448	610 x 1220
3/4 Shelf Rail Kits (1 side, 2 ends)				
MPR6009003	600 x 900	ESR24363	CBR24363	610 x 910
MPR60010003	600 x 1000	ESR24423	CBR24423	610 x 1070
MPR60011003	600 x 1100	ESR24483	CBR24483	610 x 1220

Case Pack: 1 Color: Soft Gray (151).

Single Side Rail Kits

PREMIUM CODE	LENGTH	ELEMENTS XTRA CODE	BASICS PLUS CODE	LENGTH
MPR600S	600 mm	ESR24S	—	610 mm
MPR700S	700	ESR30S	CBR30S	760
MPR800S	800	ESR36S	CBR36S	910
MPR900S	900	ESR42S	CBR42S	1070
MPR1000S	1000	ESR48S	CBR48S	1220
MPR1100S	1100	ESR54S	CBR54S	1380
MPR1200S	1200	ESR60S	CBR60S	1530
MPR1300S	1300	ESR72S	—	1830

Case Pack: 1 Color: Soft Gray (151).

Case Pack: 1
Color: Soft Gray (151).

Single End Rail Kits

PREMIUM CODE	DEPTH	ELEMENTS XTRA CODE	BASICS PLUS CODE	DEPTH
MPR300E	300 mm	ESR14E	—	360 mm
MPR400E	400	ESR18E	CBR18E	460
MPR500E	500	ESR21E	CBR21E	540
MPR600E	600	ESR24E	CBR24E	610

Case Pack: 1 Color: Soft Gray (151).

STOCK PRODUCTS & COLORS AVAILABLE IN OUR EUROPEAN WAREHOUSE

ALL SHELF RAIL KITS: (151)



CAMSHELVING® ACCESSORIES

Shelf Divider Bars (for 600/610 mm deep shelf only)

Create a custom service or storage station for food pans, boxes or dish racks. Install straight or angled dividers directly onto shelf traverses.

CODE	DESCRIPTION
Premium Series	
CSDBA	Angled Divider Bar
CSDBS	Straight Divider Bar
Elements XTRA Series	
EDBA	Angled Divider Bar
EDBS	Straight Divider Bar

Case Pack: 4
Color: Speckled Gray (480).



Ultimate Sheet Pan Rack for Single Shelf

The lightweight, durable Ultimate Sheet Pan Rack for Single Shelf will transform your storage capabilities. Designed to fit securely on a 600 mm deep Premium Shelving Unit or 610 mm deep Elements XTRA and Basics Plus unit, this single shelf rack holds 6 full size 60 x 40 cm sheet pans in a compact space. Use to stage and hold prepped ingredients, defrost product in the cooler or quickly cool baked goods. Designed to accept pans directly out of a 176°C oven. Ships knockdown.

CODE	DESCRIPTION	DIMENSION D x L x H
Premium or Elements XTRA Series		
CSUPR6040S6	60 x 40 rack	612 x 465 x 514 mm
CSUPR1826S6	66 x 46 rack	603 x 514 x 514
Basics Plus Series		
CBUPR6040S6	60 x 40 rack	612 x 465 x 514
CBUPR1826S6	66 x 46 rack	603 x 514 x 514

Case Pack: 1 **Color: Brushed Graphite (580).**
Patent Pending.



**STOCK PRODUCTS & COLORS AVAILABLE
IN OUR EUROPEAN WAREHOUSE**

CSUPR6040S6, CBUPR6040S6: (580)

Single Shelf Security Cage (for 610 mm deep shelf only)

Securely store valuable products on a single shelf. Made of heavy duty, 304 stainless steel for use in any environment. Requires 457 mm height between shelves. Install on vented shelves only. Lock not included.

CODE	DIMENSION D x L x H
CSSC244818	640 x 1080 x 460 mm

Case Pack: 1 **Color: Silver (000).**



Camshelving® Wine Rack

Full Wine Rack Units & Kits

- > Unit holds up to 144 bottles.
- > Add kits to customize existing shelving.
- > Holds standard size wine bottles.
- > Available in 360 or 460 mm depth.

Easy to Clean
Ultra Hygienic
Highly Durable



PATENT APPLIED FOR

COMPONENTS
(WINE CRADLES &
CONNECTORS NOT
INCLUDED)

UTILITY SHELVING — CAMSHELVING® WINE RACK UNITS & KITS



Four Cradle Shelf Kits, Single Stack

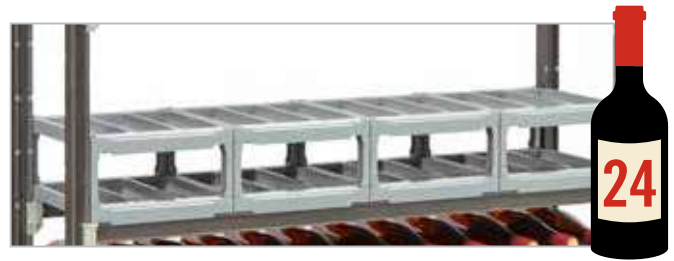

Eight Cradle Shelf Kits, Double Stack



Twelve Cradle Shelf Kits, Triple Stack



Single Cradle Add On Kits

Camshelving® Wine Rack Units

CODE	DESCRIPTION	DIMENSIONS	HOLDING CAPACITY
CBUWR144872PKG	Basics Plus Series Stationary Wine Rack Unit	360 x 1220 x 1830 mm	144 Standard Bottles of Wine (750 ml)
CBUWR184872PKG	Basics Plus Stationary Wine Rack Unit	460 x 1220 x 1830 mm	144 Standard Bottles of Wine (750 ml)

Color: Brushed Graphite (580). Each UNIT includes: Unassembled Stationary Post Kits, 8 Traverses, 48 each Wine Cradles, 32 Bags of Cradle Connectors.

Camshelving® Wine Cradle Kits

CODE	DESCRIPTION	DIMENSIONS D x W x H*	HOLDING CAPACITY
Single Cradle Add On Kits (Single Cradle with Bag of Connectors)			
CSWRKIT14P1	Wine Cradle Kit 360 mm Deep 1PK	33,7 x 28,3 x 3,8 cm	3 Bottles
CSWRKIT18P1	Wine Cradle Kit 460 mm Deep 1PK	43,9 x 28,3 x 3,8 cm	3 Bottles
Four Cradle Shelf Kits, Single Stack (Four Cradles, No Connectors)			
CSWRC14P4	Wine Cradles Only 360 mm Deep 4 EA	33,7 x 113,4 x 3,8 cm	12 Bottles
CSWRC18P4	Wine Cradles Only 460 mm Deep 4 EA	43,9 x 113,4 x 3,8 cm	12 Bottles
Eight Cradle Shelf Kits, Double Stack (Eight Cradles with 4 Bags of Connectors)			
CSWRKIT14P8	Wine Cradle Kit 360 mm Deep 8PK	33,7 x 113,4 x 16 cm	24 Bottles
CSWRKIT18P8	Wine Cradle Kit 460 mm Deep 8PK	43,9 x 113,4 x 16 cm	24 Bottles
Twelve Cradle Shelf Kits, Triple Stack (Twelve Cradles with 8 Bags of Connectors)			
CSWRKIT14P12	Wine Cradle Kit 360 mm Deep 12PK	33,7 x 113,4 x 28,6 cm	36 Bottles
CSWRKIT18P12	Wine Cradle Kit 460 mm Deep 12PK	43,9 x 113,4 x 28,6 cm	36 Bottles

Color: Soft Gray (151). *Overall length is based on 4 cradles installed side by side along 1220 mm traverses.

Optional Accessories

CODE	DESCRIPTION	DIMENSIONS D x L x H
CSFF	Floor Fastener	3,8 x 16,5 x 9,5 cm
CSWF	Wall Fastener	7,4 x 8,6 x 4,8 cm
CBDS14H6	Dunnage Stand for Basics Plus	35,6 x 16,5 cm
CSID6	Identification Tag	15,3 x 2,5 cm
CSID3	Identification Tag	7,6 x 2,5 cm

Colors: Floor and Wall Fastener Stainless Steel (000), Dunnage Stand Brushed Graphite (580), Identification Tags White/Clear (000).

CAMSHELVING®

UNIVERSAL STORAGE RACK



HOLDS EVERYTHING
food pans, boxes, sheet pans, trays, and even pizza dough boxes

A Unique Way to Create
VERTICAL STORAGE SPACE

Easily create individual storage sections with rail panels.

Available for Camshelving Premium, Elements XTRA and Basics Plus, 530 or 600 mm deep.



CREATE "DRAWER" STORAGE



VERTICAL STORAGE
between shelves
eliminates unused space



Premium® Series	600 mm depth	MPUNVR600
		MPUNVRA600
Basics Plus® Series	530 mm depth	CBUNVR21
		CBUNVRA21
	600 mm depth	CBUNVR24
		CBUNVRA24

UTILITY SHELVING — CAMSHELVING® ULTIMATE #10 CAN RACK SYSTEM

Create the can storage system your operation needs with the Ultimate #10 Can Rack. This first ever plastic can rack makes storing and inventorying #10 and #5 cans so much easier.

- Front-loading, gravity-fed system supports FIFO organization and food rotation with no need to move the rack for loading or unloading.
- Made with easy to clean, smooth surfaces. Can be completely disassembled and run through the dishwasher.
- Lifetime warranty against rust and corrosion. Made from durable, reinforced plastic material.
- Single, Add-on Can Racks and Full-Size Can Rack Units each ship complete in 1 box. Units include pre-assembled post kits.

Color: Brushed Graphite (580).

Ultimate #10 Can Rack is covered by U.S. Patents D828,145 S and D827,421 S.

NSF Component on shelving only.



Easy to assemble, a few simple parts click together to build single and add-on racks.



Storage Capacity

	#10 Can	#5 Can
SINGLE OR ADD-ON CAN RACK	8 each	12 each
FULL-SIZE CAN RACK UNIT (660 x 915 x 1830, 3 tiers)	96	144

Holds #10 and #5 cans 170 to 179 mm tall.

UTILITY SHELVING — CAMSHELVING® ULTIMATE #10 CAN RACK SYSTEM

Premium Series

Full Size Stationary Can Rack Unit

This free-standing can rack holds up to 96 cans in a compact space. Install on the end of a Camshelving High Density unit for maximum space utilization. Ships knockdown in 1 box with 2 factory-assembled post kits.



Elements XTRA Series



Full Size Stationary Add-on Can Rack Unit

Maximize every inch of linear space in your kitchen or dry storage area with an in-line can rack. With just 1 factory assembled post kit, connect a can rack to standard shelving units in a straight line by sharing posts.



Partial Can Rack Storage

Install a single row of can storage on any 610 mm deep Camshelving unit, utilizing shelf space above or below for standard storage items.



UTILITY SHELVING – CAMSHELVING® ULTIMATE #10 CAN RACK SYSTEM



CODE	CPU243672C96*	ESU243672C96*	CPA243672C96**	EA243672C96**
DESCRIPTION	Premium Series Full-Size Stationary Can Rack Unit (Free Standing)	Elements XTRA Series Full-Size Stationary Can Rack Unit (Free Standing)	Premium Series Full-Size Add-On Can Rack Unit (Shared Post)	Elements XTRA Series Full-Size Add-On Can Rack Unit (Shared Post)
DIMENSIONS D x L x H	660 x 915 x 1830 mm	660 x 915 x 1830 mm	660 x 870 x 1830 mm	660 x 864 x 1830 mm

Case Pack: 1 Ships in 1 box. **Premium Series Color:** Speckled Gray (480). **Elements XTRA Series Color:** Brushed Graphite (580).

*Unit includes: 2 pre-assembled post kits, 9 traverses, 15 panels and 72 brackets. **Unit includes: 1 pre-assembled post kit, 9 traverses, 15 panels and 72 brackets.

Single and Add-on Can Racks

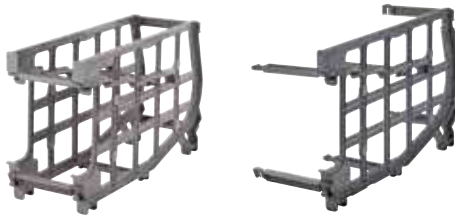

CODE	UCR10R8	UCR10AR8
DESCRIPTION	Single Can Rack, 2 panels and 6 brackets	Add-on Can Rack, 1 panel and 6 brackets
DIMENSIONS D x L x H	660 x 235 x 394 mm	660 x 191 x 394 mm

Case Pack: 1 **Color:** Brushed Graphite (580).

STOCK PRODUCTS & COLORS AVAILABLE IN OUR EUROPEAN WAREHOUSE

UCR10R8, UCR10AR8: (580)



Can Racks Per Length

SHELF LENGTH	NUMBER OF CAN RACKS PER TIER*	LEFTOVER SHELF SPACE	#10 CAN HOLDING CAPACITY
610 mm	2	89 mm	16
765	3	51	24
915	4	0	32
1070	4	165	32
1220	5	127	40
1375	6	89	48
1525	7	51	56

*1 Single Rack plus Add-on Racks.

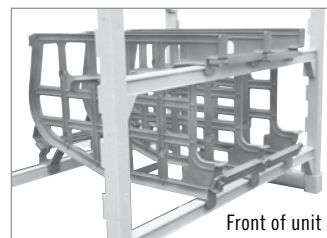

Front of unit

NOTE: Each tier of can racks requires 3 traverses, 2 front and 1 rear. Leave two open dovetails above top traverse before installing the next traverse/tier. This allows space to load cans.

CAMSHELVING® ULTIMATE SHEET PAN RACK

Designed for durability.
Buy once. Use forever.

Molded-in Rails =
No Broken Welds



Low maintenance,
Easy to clean.

Quiet, smooth glide,
swivel casters.
All with brakes.



CAMSHELVING® ULTIMATE SHEET PAN RACK

for 46 x 66 cm Sheet Pans



Full Size

Half Size

Undercounter

CODE	DIMENSIONS L x W x H*	RAIL SPACING	HOLDING CAPACITY	CASTER TYPE
Full Size Knockdown (KD) Units				
UPR1826FP20	84,8 x 64,6 x 181,9 cm	7,62 cm	20 Sheet pans/trays	Plastic
UPR1826FP40	84,8 x 64,6 x 181,9 cm	3,81 cm	40 Sheet pans/trays	Plastic
Full Size Factory Assembled (FA) Units				
UPR1826FPA20	84,8 x 64,6 x 181,9 cm	7,62 cm	20 Sheet pans/trays	Plastic
UPR1826FPA40	84,8 x 64,6 x 181,9 cm	3,81 cm	40 Sheet pans/trays	Plastic
Color: Brushed Graphite (580). *Dimensions include 12,7 cm plastic casters. Weight capacity: 158,75 kg. per rack, 24,95 kg. per rail set.				
Half Size Knockdown (KD) Units				
UPR1826HP12	81,4 x 64,8 x 120,6 cm	7,62 cm	12 Sheet pans/trays	Plastic
UPR1826HP20	84,8 x 64,6 x 105,1 cm	3,81 cm	20 Sheet pans/trays	Plastic
Color: Brushed Graphite (580). *Dimensions include 12,7 cm plastic casters. Weight capacity: 79,38 kg. per rack, 24,95 kg. per rail set.				
Undercounter Knockdown (KD) Units				
UPR1826U8	78,4 x 59,1 x 84,1 cm	7,62 cm	8 Sheet pans/trays	Metal
UPR1826U15	78,4 x 59,1 x 80 cm	3,81 cm	15 Sheet pans/trays	Metal
Color: Brushed Graphite (580). *Dimensions include 7,62 cm metal casters. Weight capacity: 40,82 kg. per rack, 24,95 kg. per rail set.				

CAMSHELVING® GN FOOD PAN TROLLEYS

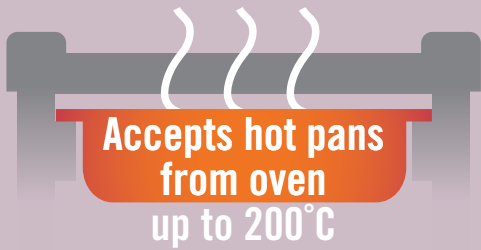

Highly Durable

Low Maintenance

Quiet, smooth glide, swivel
casters. All with brakes.



Use in Kitchen, Freezer or Cooler



GN 1/1 Trolleys

1 full-size pan
per rail set, end load



UGNPR11H9
D 73,03 x L 43,8 x H 101,6 cm

UGNPR11F18
D 73,03 x L 43,8 x H 170,7 cm

6,5 cm **x9**

6,5 cm **x18**

10 cm **x4**

10 cm **x9**

GN 2/1 Trolleys

2 full-size pans
per rail set, side load



UGNPR21H18
D 83,5 x L 64,5 x H 101,6 cm

UGNPR21F36
D 83,5 x L 64,5 x H 170,7 cm

6,5 cm **x18**

6,5 cm **x36**

10 cm **x8**

10 cm **x18**



Unique top frame holds a full size food pan or cutting board. Use to protect contents below or create a light duty work space.

PAN STOPS

Lock and secure pans on rails, especially during transport.

For GN Food Pan Trolleys

UGNPRPSF (Full Size)

UGNPRPSH (Half Size)

For Sheet Pan Racks

UPRPSF (Full Size)

UPRPSH (Half Size)



UTILITY SHELVING

Premium Series Full-Wrap Security Cage for D 610 x L 1220 mm shelf and H 1700 mm stationary or H 1778 mm mobile

Store valuable products behind locked doors. Made of heavy-duty 304 stainless steel for use in any environment. Stationary or mobile units ship complete with factory assembled post kits, 2 vented shelves, 4 premium swivel casters with total locking brake for mobile unit and 1 full wrap security cage. Can be used with Divider Panels. Assembly requires bottom vented shelf. Additional shelves can be ordered separately. Cage and Units ship knockdown. Lock not included.

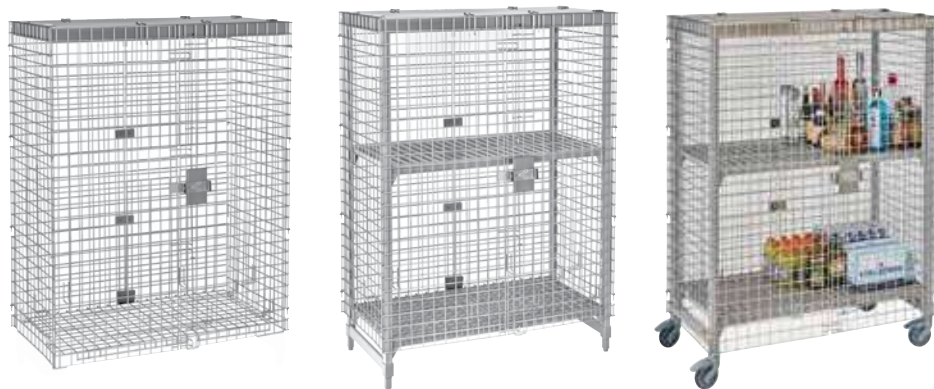

CODE	CPFWSC244860	CPU244864SUPKG	CPMU244867SUPKG
DESCRIPTION	Full-wrap Security Cage only	Full-wrap Stationary Security Unit	Full-wrap Mobile Security Unit
DIMENSION D x L x H	680 x 1276 x 1562 mm	680 x 1276 x 1638 mm	680 x 1276 x 1721 mm
COLOR	Silver (000)	Speckled Gray (480)	Speckled Gray (480)

Case Pack: 1 Cage only ships in 1 box. Units ship in 2 boxes.
Fit only Camshelving Premium Series made in the USA. Special Order. Allow 10 to 12 weeks for delivery for International delivery.

Vertical Drying and Storage Rack

Promotes sanitary drying, safe handling and efficient storage for trays, sheet pans, cutting boards and lids. Can be used with Shelf Rails to prevent contents from sliding off.

Units ship complete with factory assembled mobile post kits, 6 traverses, 12 or 15 vertical drying cradles and premium swivel casters with total locking brake. Assembly required.



Modular 7-slot rack can be ordered separately to customize a drying and storage rack. Made of highly durable ABS plastic. Slots are spaced 3,33 cm wide and dividers are 6,35 cm high.



CODE	DIMENSIONS D x L x H	HOLDING CAPACITY	CASE PACK
Premium Series Vertical Drying and Storage Rack			
MPMU61117DRPKG	600 x 1180 x 1790 mm	84 Trays	1
MPMU61317DRPKG	600 x 1380 x 1790	105 Trays	1
Vertical Drying and Storage Cradle for 600 mm deep shelf only (Fits all Camshelving® lines)			
CSDR7	597 x 260 x 95	—	1
CSDR73	597 x 260 x 95	—	3

Drying Rack Color: Speckled White (490). **Drying Cradle Color:** Soft Gray (151).
1220 mm long unit ships in 5 boxes. 1530 mm long unit ships in 6 boxes.

STOCK PRODUCTS & COLORS AVAILABLE IN OUR EUROPEAN WAREHOUSE

MPMU61117DRPKG, MPMU61317DRPKG: (490)
CSDR7, CSDR73: (151)

UTILITY SHELVING

Angled Drying and Storage Rack

Promotes sanitary drying, safe handling and efficient product organization with easy access to product.

Unit ships complete with factory assembled mobile post kits, 8 traverses, 16 angled drying cradles and premium swivel casters with total locking brake. Assembly required.



Uniquely designed cradle holds up to 8 each meal delivery pellets or use to dry, store and transport food pans and other commercial kitchen ware. Installs directly onto shelf traverses. Made of highly durable ABS plastic. Slots are spaced 6,03 cm apart.



CODE	DIMENSIONS D x L x H	HOLDING CAPACITY	CASE PACK
Premium Series Angled Drying and Storage Rack			
MPMU61217PDPKG	600 x 1280 x 1790 mm	128 Pellets and Bases or 16 GN 1/1 Food Pans	1
Angled Drying and Storage Cradle for 600 mm deep shelf only (Fits all Camshelving® lines)			
CSDR8	592 x 263 x 160	—	1
CSDR84	592 x 263 x 160	—	4

Drying Rack Color: Speckled White (490). MPMU61217PDPKG Ships in 5 boxes.

Drying Cradle Color: Soft Gray (151).

**STOCK PRODUCTS & COLORS
AVAILABLE IN OUR EUROPEAN
WAREHOUSE**

MPMU61217PDPKG: (490)
CSDR8, CSDR84: (151)

Dome Drying and Storage Rack

Promotes sanitary drying, safe handling and efficient product organization with easy access to product.

Unit ships complete with factory assembled mobile post kits, 10 traverses, 10 dome drying cradles and premium swivel casters with total locking brake. Assembly required.



Use to dry and safely store up to 10 patient meal delivery domes or plate covers upright. Installs directly onto shelf traverses. Made of highly durable ABS plastic. Slots are spaced 7,78 cm apart.



CODE	DIMENSIONS D x L x H	HOLDING CAPACITY	CASE PACK
Premium Series Dome Drying and Storage Rack			
MPMU6917DDPKG	600 x 980 x 1790 mm	100 Domes	1
Dome Drying and Storage Cradle for 600 mm deep shelf only (Fits all Camshelving® lines)			
CSDDC24	597 x 415 x 86	—	1
CSDDC245	597 x 415 x 86	—	5

Drying Rack Color: Speckled White (490). MPMU6917DDPKG Ships in 3 boxes.

Drying Cradle Color: Soft Gray (151).

UTILITY SHELVING

Elements® XTRA Series 2-Shelf Vented Undercounter Units

Create storage in underutilized or hard-to-reach undercounter areas. Ideal for storing condiments, to-go containers, and paper disposables. Stationary units include 2 factory assembled stationary post kits, 4 stationary traverses, stationary traverse dovetails and shelf plates.

Mobile units include 2 factory assembled mobile post kits, 4 mobile traverses, mobile traverse dovetails, shelf plates, and 4 premium swivel casters with total locking brake.



CODE	DIMENSIONS D x L x H*
Stationary Units	
EXU183630V2	460 x 915 x 765 mm
EXU184830V2	460 x 1220 x 765
Mobile Units	
EXMU142427V2	360 x 610 x 685
EXMU143627V2	360 x 915 x 685
EXMU144827V2	360 x 1220 x 685

Color: Brushed Graphite (580). Ships in 1 box. *Height includes casters.

Premium Series Flex Stations

This versatile unit can serve as a convenient Grab and Go station, product merchandiser, or use for delivery staging area, utensil storage and much more.

Unit Includes: 2 factory assembled mobile post kits, 8 traverses, 36 angled divider bars (4 extra) 4 total locking casters and 24 identification tags. Assembly required.

Food pans, food boxes and other accessories sold separately.



CODE	DESCRIPTION	DIMENSIONS D x L x H*
CPMU244867FXPKG	Premium Series Flex Station	610 x 1220 x 1778 mm

Color: Speckled Gray (480). Ships in 1 box. *Height includes casters.

CAMSHELVING® WALL SHELVES AND SHELF EXTENDERS



Wall Shelves

- Expand storage space in kitchens, above work stations and sinks.
- Features virtually indestructible I-beam supports that hold up to 68 kg per shelf.
- Durable polypropylene withstands temperatures up to 88°C, and will not rust or corrode.

- Snap fit rail design allows shelves to snap on and off for easy cleaning.
- 5 cm backsplash and marine front edge controls spills and cross contamination.

Shelf Extenders

- Convert empty wall space into a functional storage area.
- Use with or without Camshelving Wall Shelves.
- Peg strips withstand temperatures up to 88°C, and will not rust or corrode.

Wall Shelf Color: Speckled Grey (480).

Extender Peg Strip Color: Black (110).



COMPONENT



Shelf Extenders ship in one carton and include:

LENGTH	PEG		
	STRIPS	BRACKETS	HOOKS
910 mm	3	2	6
1220 mm	3	3	9

STOCK PRODUCTS & COLORS AVAILABLE IN OUR EUROPEAN WAREHOUSE

CSWS1436SK, CSWS1448SK, CSWS1836SK, CSWS1848SK: (480)

Wall Shelves 360 mm Depth



CODE	CSWS1436SK	CSWS1448SK	CSWS1436VK	CSWS1448VK
DESCRIPTION	910 mm wall shelf, solid	1220 mm wall shelf, solid	910 mm wall shelf, vented	1220 cm wall shelf, vented
EXTERIOR DIMENSIONS	L 915 x D 360 x H 340 mm	L 1220 x D 360 x H 340 mm	L 915 x D 360 x H 340 mm	L 1220 x D 360 x H 340 mm

Case Pack: 1

Wall Shelves 460 mm Depth



CODE	CSWS1836SK	CSWS1848SK
DESCRIPTION	910 mm wall shelf, solid	1220 mm wall shelf, solid
EXTERIOR DIMENSIONS	L 915 x D 460 x H 340 mm	L 1220 x D 460 x H 340 mm

Case Pack: 1

Shelf Extenders

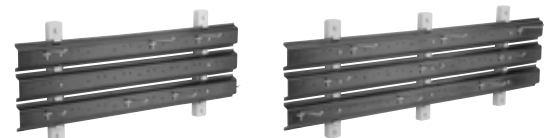

CODE	CSWS36EK	CSWS48EK
DESCRIPTION	910 mm Shelf Extender	1220 mm Shelf Extender
EXTERIOR DIMENSIONS	L 900 x D 50 x H 390 mm	L 1220 x D 50 x H 390 mm

Case Pack: 1

S-SERIES DUNNAGE RACKS AND CAMLINK®



S-Series Dunnage Racks

- Keep frozen, cold or dry inventory 30,5 cm safely off the floor.
- One piece construction and sturdy legs provide strength and stability.
- Heavy duty polypropylene is safe to -38°C, and will not rust, corrode or bend.
- Choose slotted tops for maximum air circulation around perishable products.
- Solid tops catch spills for easy clean up.

Colors: Dark Brown (131),
Speckled Gray (480).



STOCK PRODUCTS & COLORS AVAILABLE IN OUR EUROPEAN WAREHOUSE

DRS300, DRS360, DRS480, DRS600: (480)



CODE	EXTERIOR DIM. H x D x W	LOAD CAPACITY
Solid Top		
DRS30	300 x 533 x 760 mm	680 kg
DRS36	300 x 533 x 915	680
DRS48	300 x 533 x 1220	1,360
DRS60	300 x 533 x 1525	1,360
Slotted Top		
DRS300	300 x 533 x 760	680
DRS360	300 x 533 x 915	680
DRS480	300 x 533 x 1220	1,360
DRS600	300 x 533 x 1525	1,360

Case Pack: 1

Camlink

Camlink connectors securely lock dunnage racks together for greater stability.



CODE	CASE PACK
DRLNK	6

Color: Black (110).

Camlink fits all sizes and styles. One free Camlink supplied with every Dunnage Rack.



CAMBRO[®] FOOD STORAGE

Commitment to food safety relies on durable, consistent food storage products. Prep, store and serve across a wide range of temperatures and environments. All of our food storage products resist acid, oils, stains, and odors. That means years of service in a commercial kitchen without compromising quality.



The Most Efficient Food Storage System Ever



STORAGE²



Virtually unbreakable.
Withstands temperatures from
Polycarbonate: -40° to 99°C
Polypropylene: -40° to 70°C

SEVEN SIZES
from 1,9 - 20,8 L

2 MATERIALS
Polycarbonate & Polypropylene



RECESSED HANDLES

HELPFUL MARKS

Color graduations are printed on the outside for quick inventory management.

Graduation marks are both engraved and color-printed to ensure long-term readability.

**25%
MORE**

Storage Capacity



with 11,3 to 20,8 L CamSquares FreshPro containers

Note: All graduations are approximate.

FRESHNESS²



Easy Seal Cover

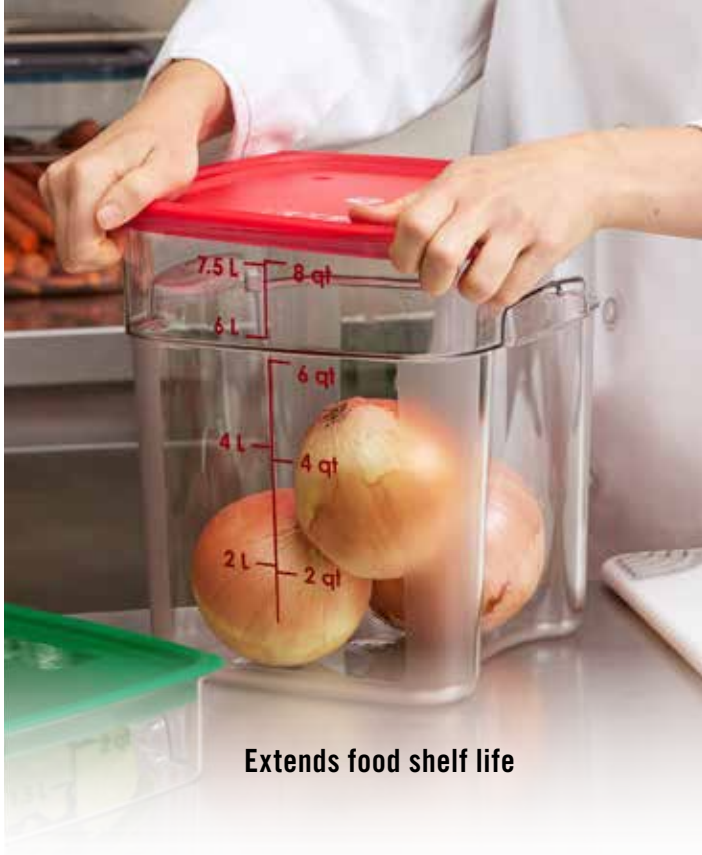

Extends food shelf life



Easy on/off cover



Prevents spills

Maximizes Freshness

Extends shelf life by

2 DAYS



INDUSTRY-FIRST

Drain shelves for square storage containers

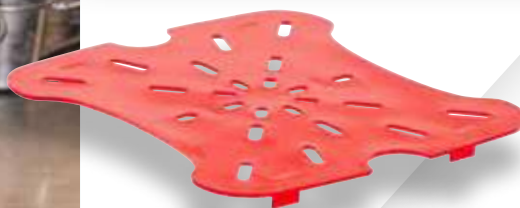

FOOD SAFETY²



Cross stacking allows sanitary drying



Easy Seal Cover prevents cross-contamination



Peg holes on drain shelves and covers promote sanitary drying



Drain holes in handles promote sanitary drying

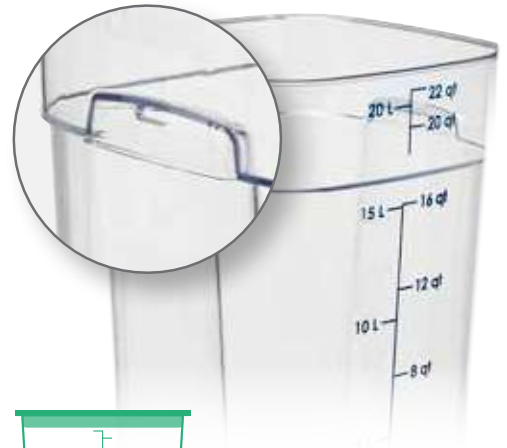

EFFICIENCY²

Color-Coded Efficiency

Matching covers, drain shelves and graduation marks



ERGONOMICS²



Curved Corners & Recessed Handles



**Curved corners for
safe 4-sided pouring**



Ergonomic handling



Textured grip



**Easy to
carry**



POLYCARBONATE CAMSQUARE® FRESHPRO FOOD STORAGE CONTAINERS



Polycarbonate Food Storage Containers



CODE	2SFSPROCW	4SFSPROCW	6SFSPROCW	8SFSPROCW	12SFSPROCW	18SFSPROCW	22SFSPROCW
CAPACITY	1,9 L	3,8 L	5,7 L	7,6 L	11,4 L	17 L	19 L
DIM. L x W x H (CM)	19 x 19 x 10	19 x 19 x 18	23 x 23 x 18	23 x 23 x 24	29 x 29 x 22	29 x 29 x 33	29 x 29 x 41

Case Pack: 6 Color: Clear (135).

Easy Seal Covers

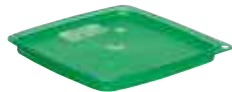

CODE	SFC2FPPP	SFC6FPPP	SFC12FPPP
DESCRIPTION	Fits 2 & 3,8 L	Fits 5,7 & 7,5 L	Fits 11, 17 & 19 L
COLOR	Translucent Green (265)	Translucent Red (266)	Translucent Blue (267)

Case Pack: 6. FreshPro Easy Seal Covers not compatible with CamSquares Classic Series Containers.

Drain Shelves

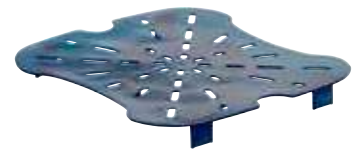
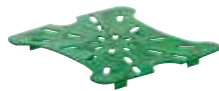

CODE	2SFSFPDPP	6SFSFPDPP	12SFSFPDPP
DESCRIPTION	Fits 2 & 3,8 L	Fits 5,7 & 7,5 L	Fits 11, 17 & 19 L
COLOR	Translucent Green (265)	Translucent Red (266)	Translucent Blue (267)

Case Pack: 6. FreshPro Drain Shelves not compatible with CamSquares Classic Series Containers.

Patent Applied For

POLYCARBONATE CAMSQUARE® CLASSIC FOOD STORAGE CONTAINERS



Polycarbonate CamSquares Classic Series



CODE	2SFSCW	4SFSCW	6SFSCW	8SFSCW	12SFSCW**	18SFSCW**	22SFSCW**
CAPACITY	1,9 L	3,8 L	5,7 L	7,6 L	11,4 L	17,2 L	20,8 L
DIM. L x W x H (CM)	18,5 x 18,5 x 10	18,5 x 18,5 x 18,7	21,5 x 21,5 x 18,5	21,5 x 21,5 x 23	25,6 x 31 x 21	25,6 x 31 x 32	25,6 x 31 x 40

Case Pack: 6 Color: Clear (135). Height includes covers. **Dimensions include handles.

STOCK PRODUCTS & COLORS AVAILABLE IN OUR EUROPEAN WAREHOUSE

ALL CAMWEAR: (135)

Seal Covers for Polycarbonate CamSquare Classic Series*



CODE	SFC2SCPP	SFC6SCPP	SFC12SCPP
DESCRIPTION	Fits 1,9 & 3,8 L	Fits 5,7 & 7,6 L	Fits 11,4, 17,2 & 20,8 L

Case Pack: 6 Color: Translucent (190).

STOCK PRODUCTS & COLORS AVAILABLE IN OUR EUROPEAN WAREHOUSE

SFC2SCPP, SFC6SCPP, SFC12SCPP: (190)

Note: All graduations are approximate.

*Seal Covers fit Camwear CamSquare Classic containers only and are not airtight.

Personalization available on non-food contact areas only. See cresting section for information, ordering and pricing.



2
PRORATED

TRANSLUCENT CAMSQUARE® FRESHPRO FOOD STORAGE CONTAINERS



Ideal for Fresh herbs
Spice blends
Condiments
Mise en place

INDUSTRY-FIRST
Commercial Grade
One Liter and Half Liter Sizes



The Reusable and Sustainable Solution



Reusable replacement
for single-use
containers



Easy Seal Cover



- Stays firmly in place**
- Prevents spills**
- Extends food shelf life**
- Easy on/off cover**
- Peg hole for sanitary drying**

One-Handed Carry



One Cover Fits Both Container Sizes



Translucent Polypropylene Food Storage Containers



HFSFSPROPP
CAPACITY: ½ L
DIMENSIONS L x W x H: 12 cm x 12 cm x 6,5 cm
Case Pack: 6 **Color:** Translucent (190).



1SFSPROPP
CAPACITY: 1 L
DIMENSIONS L x W x H: 12 cm x 12 cm x 11,8 cm
Case Pack: 6 **Color:** Translucent (190).

Personalization



Easy Seal Cover



SFC1FPPP
DESCRIPTION: Fits ½ & 1 L
Case Pack: 6 **Color:** Translucent (190).

POLYPROPYLENE CAMSQUARE® FRESHPRO FOOD STORAGE CONTAINERS



Translucent Polypropylene Food Storage Containers



CODE	2SFSPROPP	4SFSPROPP	6SFSPROPP	8SFSPROPP	12SFSPROPP	18SFSPROPP	22SFSPROPP
CAPACITY	1,9 L	3,8 L	5,7 L	7,6 L	11,4 L	17 L	19 L
DIM. L x W x H (CM)	19 x 19 x 10	19 x 19 x 18	23 x 23 x 18	23 x 23 x 24	29 x 29 x 22	29 x 29 x 33	29 x 29 x 41

Case Pack: 6 Color: Translucent (190).

Easy Seal Covers

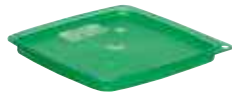

CODE	SFC2FPPP	SFC6FPPP	SFC12FPPP
DESCRIPTION	Fits 2 & 3,8 L	Fits 5,7 & 7,5 L	Fits 11, 17 & 19 L
COLOR	Translucent Green (265)	Translucent Red (266)	Translucent Blue (267)

Case Pack: 6. FreshPro Easy Seal Covers not compatible with CamSquares Classic Series Containers.

Drain Shelves

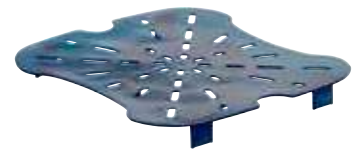
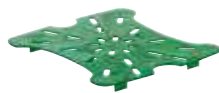

CODE	2SFSFPDPP	6SFSFPDPP	12SFSFPDPP
DESCRIPTION	Fits 2 & 3,8 L	Fits 5,7 & 7,5 L	Fits 11, 17 & 19 L
COLOR	Translucent Green (265)	Translucent Red (266)	Translucent Blue (267)

Case Pack: 6. FreshPro Drain Shelves not compatible with CamSquares Classic Series Containers.

Patent Applied For

CAMSQUARES® CLASSIC SERIES TRANSLUCENT POLYPROPYLENE & POLYETHYLENE FOOD STORAGE CONTAINERS



Translucent Polypropylene

- Translucent material provides some content visibility and high chemical resistance.
- Withstands temperatures from -40° to 70°C.
- Easy to read graduations are printed on the outside for at a glance inventory management.

Note: All graduations are approximate.



Polyethylene

- Economical storage choice.
- Made of impact, stain and chemical resistant opaque material.
- Withstands temperatures from -40° to 70°C.

Note: All graduations are approximate.



Covers for Camwear® CamSquares Classic Series Translucent and Poly CamSquares

- Snap-tight polyethylene covers feature thumb tabs for easy removal.
- Colored covers match up with colored graduation marks on containers.



Personalization

Personalize food storage products to identify menu items, add fill lines for recipes, or use personalization in multiple languages to help ensure product quality and consistency.

For more information see the "Promote Your Brand" page located in the Table section of this catalog.



CAMSQUARES® CLASSIC SERIES TRANSLUCENT POLYPROPYLENE & POLYETHYLENE FOOD STORAGE CONTAINERS



Translucent Polypropylene



CODE	2SFSP	4SFSP	6SFSP	8SFSP	12SFSP**	18SFSP**	22SFSP**
CAPACITY	1,9 L	3,8 L	5,7 L	7,6 L	11,4 L	17,2 L	20,8 L
DIM. L x W x H (CM)	18,5 x 18,5 x 10	18,5 x 18,5 x 18,7	21,5 x 21,5 x 18,5	21,5 x 21,5 x 23	25,6 x 31 x 21	25,6 x 31 x 32	25,6 x 31 x 40

Case Pack: 6 Color: Translucent (190). Height includes covers. **Dimensions include handles.

STOCK PRODUCTS & COLORS AVAILABLE IN OUR EUROPEAN WAREHOUSE

2SFSP, 4SFSP, 6SFSP, 8SFSP, 12SFSP, 18SFSP, 22SFSP: (190)

Polyethylene



CODE	2SFSP	4SFSP	6SFSP	8SFSP	12SFSP**	18SFSP**	22SFSP**
CAPACITY	1,9 L	3,8 L	5,7 L	7,6 L	11,4 L	17,2 L	20,8 L
DIM. L x W x H (CM)	18,5 x 18,5 x 10	18,5 x 18,5 x 18,7	21,5 x 21,5 x 18,5	21,5 x 21,5 x 23	25,6 x 31 x 21	25,6 x 31 x 32	25,6 x 31 x 40

Case Pack: 6 Color: Natural White (148). Height includes covers. **Dimensions include handles.

Universal Covers*



CODE	SFC2	SFC6	SFC12
COLOR	Kelly Green (452)	Winter Rose (451)	Midnight Blue (453)
DESCRIPTION	Fits 1,9 & 3,8 L	Fits 5,7 & 7,6 L	Fits 11,4, 17,2 & 20,8 L

Case Pack: 6

STOCK PRODUCTS & COLORS AVAILABLE IN OUR EUROPEAN WAREHOUSE

SFC2: (452)
SFC6: (451)
SFC12: (453)

Note: All graduations are approximate.

*Fit all Camsquares Classic Series.

Personalization available on non-food contact areas only. See cresting section for information, ordering and pricing.



CAMWEAR® POLYCARBONATE ROUND FOOD STORAGE CONTAINERS



Store ingredients, or transport ready-to-serve, or carry partially-prepared foods. Clear Camwear allows for easy content identification at a glance. Reduce the risk of contamination and enhance food safety. Round shape promotes proper air circulation, and is ideal for stirring soups and sauces.

STRONG & CLEAR

Virtually unbreakable Polycarbonate withstands temperatures from -40°C to 99°C

QUALITY, MOLDED IN

Broad, molded-in handles on the larger sizes ease carrying while the holes allow for quick and sanitary drying.



INVENTORY MANAGEMENT

Color graduations are printed on the outside for quick inventory management.

Graduation marks are both engraved AND color printed to ensure long-term readability.

STAIN-RESISTANT

Resists food acids, oils & alcohol odors and stains.

CAMWEAR POLYCARBONATE COVERS

- Snap on covers fit tightly.
- Stain resistant to food acids & oils.
- Withstands temperatures from -40°C to 99°C.



SPILL-RESISTANCE

Inner and outer seals provide excellent spill resistance.

CAMWEAR® ROUND STORAGE CONTAINERS



Camwear



CODE	RFSCW1	RFSCW2	RFSCW4	RFSCW6	RFSCW8	RFSCW12	RFSCW18	RFSCW22
CAPACITY	0,9 L	1,9 L	3,8 L	5,7 L	7,6 L	11,4 L	17,2 L	20,8 L
TOP DIAMETER (CM)	15,4	20,8	20,8	25,2	25,2	37,8	37,8	37,8
HEIGHT (CM)	12,7	11,1	21,8	20,2	27,6	21,3	30,5	38,1
CASE PACK	12	12	12	12	12	6	6	6

Color: Clear (135). Top diameter dimension includes handle. Height dimension includes cover. Two year warranty on Camwear Rounds.



Camwear Covers

DESCRIPTION	CASE PACK	CODE
Fits 0,9 L	12	RFSCWC1
Fits 1,9 L & 3,8 L	12	RFSCWC2
Fits 5,7 L & 7,6 L	12	RFSCWC6
Fits 11,4 L, 17,2 L & 20,8 L	6	RFSCWC12

Color: Clear (135).

Seal Covers for Camwear Rounds

DESCRIPTION	CASE PACK	CODE
Fits 0,9 L	12	RFS1SCPP
Fits 1,9 L & 3,8 L	12	RFS2SCPP
Fits 5,7 L & 7,6 L	12	RFS6SCPP
Fits 11,4 L, 17,2 L & 20,8 L	6	RFS12SCPP

Color: Translucent (190).

TRANSLUCENT POLYPROPYLENE & POLYETHYLENE ROUND FOOD STORAGE CONTAINERS



Translucent Polypropylene

- Translucent material offers some product visibility.
- Rounds are durable and resistant to stains.
- Withstands temperatures from -40° to 70°C.
- Snap on covers fit tightly to protect contents and extend product freshness.

Note: All graduations are approximate.

Note: To order Round Food Storage Containers without imprinted graduations, simply add "N" to the end of the code number.

Lids are not interchangeable.



Polyethylene

- Impact, stain and chemical resistant material.
- An affordable storage choice.
- Safe from -40° to 70°C.
- Snap on covers fit tightly yet are easily removed.

Note: All graduations are approximate.

Note: To order Round Food Storage Containers without imprinted graduations, simply add "N" to the end of the code number.

Lids are not interchangeable.



TRANSLUCENT POLYPROPYLENE & POLYETHYLENE ROUND FOOD STORAGE CONTAINERS



Translucent Polypropylene



CODE	RFS1PP	RFS2PP	RFS4PP	RFS6PP	RFS8PP	RFS12PP	RFS18PP	RFS22PP
CAPACITY	0,9 L	1,9 L	3,8 L	5,7 L	7,6 L	11,4 L	17,2 L	20,8 L
TOP DIAMETER (CM)	15,4	20,8	20,8	25,2	25,2	37,8	37,8	37,8
HEIGHT (CM)	12,7	11,1	21,8	20,2	27,6	21,3	30,5	38,1
CASE PACK	12	12	12	12	12	6	6	6

Color: Translucent (190). Top diameter dimension includes handle. Height dimension includes cover.

Polyethylene



CODE	RFS1	RFS2	RFS4	RFS6	RFS8	RFS12	RFS18	RFS22
CAPACITY	0,9 L	1,9 L	3,8 L	5,7 L	7,6 L	11,4 L	17,2 L	20,8 L
TOP DIAMETER (CM)	15,4	20,8	20,8	25,2	25,2	37,8	37,8	37,8
HEIGHT (CM)	12,7	11,1	21,8	20,2	27,6	21,3	30,5	38,1
CASE PACK	12	12	12	12	12	6	6	6

Color: Natural White (148). Top diameter dimension includes handle. Height dimension includes cover.

Covers for Translucent Polypropylene Rounds

DESCRIPTION	CASE PACK	CODE
Fits 0,9 L	12	RFSC1PP
Fits 1,9 L & 3,8 L	12	RFSC2PP
Fits 5,7 L & 7,6 L	12	RFSC6PP
Fits 11,4 L, 17,2 L & 20,8 L	6	RFSC12PP

Color: Translucent (190).

Covers for Polyethylene Rounds

DESCRIPTION	CASE PACK	CODE
Fits 0,9 L	12	RFSC1
Fits 1,9 L & 3,8 L	12	RFSC2
Fits 5,7 L & 7,6 L	12	RFSC6
Fits 11,4 L, 17,2 L & 20,8 L	6	RFSC12

Color: Natural White (148).

CAMWEAR® FOOD STORAGE BOXES

ELIMINATE THE HAZARD OF CROSS CONTAMINATION



Extend the freshness of ingredients and eliminate points of cross contamination by transferring product into food boxes at the receiving dock. A safe solution for storing bulk fruits and vegetables. Clear Camwear allows visibility for product identification. Snap tight Camwear Flat Lids or SlidingLids, sold separately, remain in place and won't come off during transport.

Camwear and Poly Lids are not interchangeable.

SlidingLids are covered by the following U.S. Patents D 447,906 S & 6,540,098 B1.



Available in Safety Red or Yellow to reduce the risk of cross contamination.

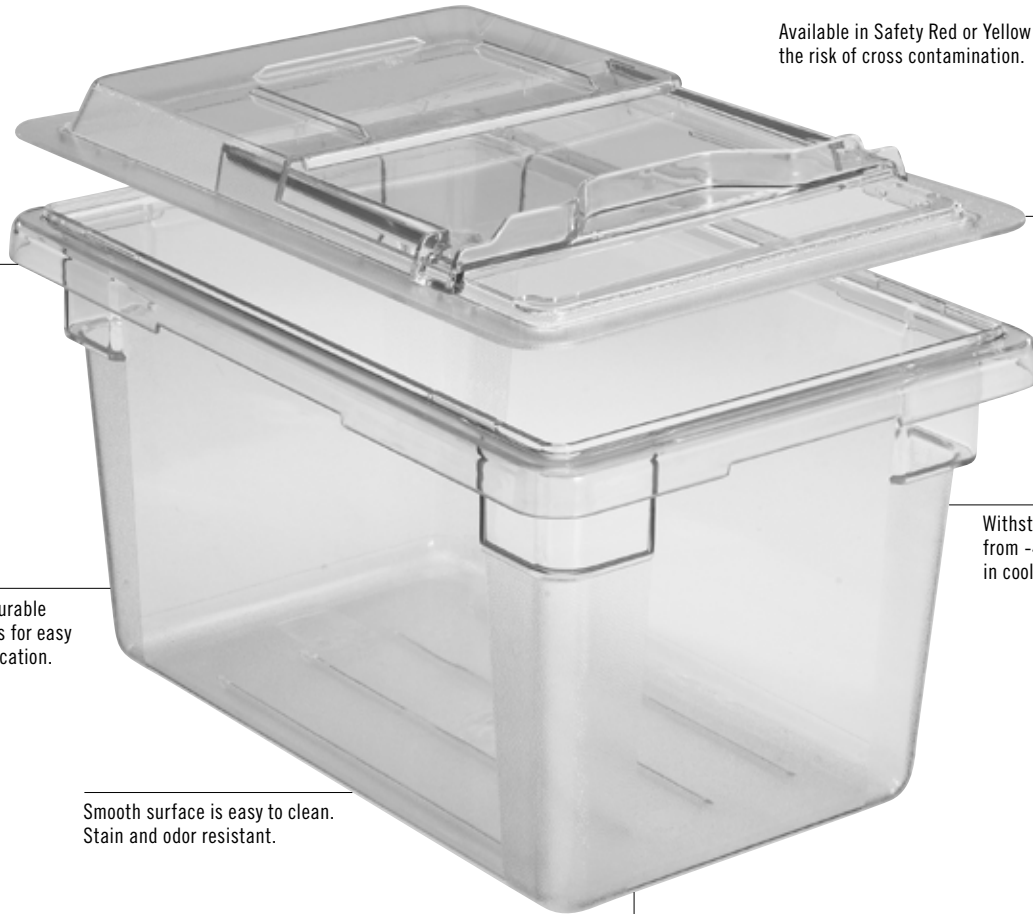

Molded-in handles ease carrying.

SlidingLid provides easy access to contents without removing the lid.

Crystal clear, durable Camwear allows for easy product identification.

Withstands temperatures from -40° to 99°C for use in coolers and freezers.

Smooth surface is easy to clean. Stain and odor resistant.

Texturing on bottom of boxes reduces scratching.

Camwear Flat Lids

- Snap-tight covers won't come off during transport.
- Top molded-in rails for safer, more secure stacking.
- Durable Camwear is safe from -40° to 99°C.

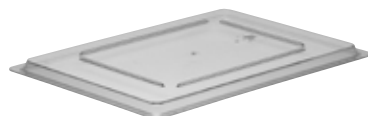

Camwear SlidingLids™

- Lid slides back to easily access contents, minimizing handling.
- Reduces the risk of cross contamination since lid remains on food box.
- Made of virtually unbreakable Camwear.



CAMWEAR® FOOD STORAGE BOXES



Camwear Food Storage Boxes



CODE	18263CW	❖● 18266CW	18269CW
DIMENSIONS (CM)	46 x 66 x 9	46 x 66 x 15	46 x 66 x 23
APPROX. CAPACITY (L)	18,9	33,1	49,2
CASE PACK	6	6	4



CODE	182612CW	182615CW	12183CW	❖● 12186CW	❖ 12189CW
DIMENSIONS (CM)	46 x 66 x 30	46 x 66 x 38	30,5 x 46 x 9	30,5 x 46 x 15	30,5 x 46 x 23
APPROX. CAPACITY (L)	64,4	83,3	6,6	11,4	18
CASE PACK	4	3	6	6	6

Color: Clear (135). 18266CW & 12186CW available in: ● Safety Red (467), ❖ Safety Yellow (464). Please contact customer service for more information.

Camwear Covers



CODE	❖● 1826CCW FLAT LID	1826SCCW SLIDINGLID™	❖● 1218CCW FLAT LID	1218SCCW SLIDINGLID
DIMENSIONS (CM)	45,7 x 66	45,7 x 66	30,5 x 45,7	30,5 x 45,7

Case Pack: 6 Color: Clear (135). 1826CCW & 1218CCW available in: ● Safety Red (467), ❖ Safety Yellow (464).

STOCK PRODUCTS & COLORS AVAILABLE IN OUR EUROPEAN WAREHOUSE

18263CW, 18266CW, 18269CW, 182612CW, 182615CW, 12183CW, 12186CW, 12189CW, 1826CCW, 1218CCW: (135)

CAMWEAR® FOOD STORAGE BOX ACCESSORIES

ColanderKit™

- A complete food safety system packaged in one carton.
- Store raw meats, fish on ice or bulk produce safely.
- Juices and liquids drip into the food box below for quick and easy disposal.

- Reduces handling and risk of cross contamination.
- ColanderKit Includes:
 - 1 - 20 cm Deep Colander
 - 1 - 46 x 66 x 23 cm Food Box
 - 1 - 46 x 66 cm SlidingLid™



Camwear Colanders

- Enhances food quality and reduces risk of cross contamination.
- Liquids and juices drain directly into food box for improved food safety.

- Ideal for draining fruits and vegetables, thawing meat or poultry, or storing seafood on ice.
- Fits Camwear 46 x 66 cm Food Storage Boxes only.



Drain hole dimension: 9,5 mm

Camwear Drain Shelves

- Lifts contents out of liquids to enhance food quality and freshness.

- Made of virtually unbreakable Camwear.
- Camwear drain shelves fit in both Camwear boxes and white poly boxes.



Accessories



CODE	1826DSCW	1218DSCW	1826CLRCW (12,7 CM DEEP)	18268CLRCW (20 CM DEEP)	18268CLRKIT
DESCRIPTION	Drain shelf	Drain shelf	Colander	Colander	ColanderKit
DIMENSIONS	Fits all 46 x 66 cm food storage boxes	Fits all 30,5 x 46 cm food storage boxes	Fits Camwear food storage boxes only 46 x 66 x 15 cm and deeper	Fits Camwear food storage boxes only 46 x 66 x 23 cm and deeper	One 20 cm deep colander one 46 x 66 x 23 cm food box one 46 x 66 cm SlidingLid™
CASE PACK	6	6	6	4	1 Kit

Color: Clear (135).

POLYETHYLENE FOOD STORAGE BOXES & CAMWEAR® ACCESSORIES



Polyethylene Food Storage Boxes



- Economical choice for storing bulk produce and ingredients.
- Impact, stain and chemical resistant material.
- Withstands temperatures from -40° to 70°C.



CODE	18263P	18266P	18269P
DIMENSIONS (CM)	46 x 66 x 9	46 x 66 x 15	46 x 66 x 23
APPROX. CAPACITY	18,9 L	33,1 L	49,2 L
CASE PACK	6	6	6



CODE	182612P	182615P	12183P	12186P	12189P
DIMENSIONS (CM)	46 x 66 x 30	46 x 66 x 38	30,5 x 46 x 9	30,5 x 46 x 15	30,5 x 46 x 23
APPROX. CAPACITY	64,4 L	83,3 L	6,6 L	11,4 L	18 L
CASE PACK	4	3	6	6	6

Color: Natural White (148).

Polyethylene Covers



CODE	1826CP FLAT LID	1218CP FLAT LID
DIMENSIONS (CM)	45,7 x 66	30,5 x 45,7

Color: Natural White (148). Case Pack: 6

STOCK PRODUCTS & COLORS AVAILABLE IN OUR EUROPEAN WAREHOUSE

1826DSCW, 1826CLRCW, 18268CLRCW: (135)
1826CP, 18269P, 182615P: (148)

Camwear and Polyethylene Lids are not interchangeable.

Camchiller®

- Extend cold holding time or enhance safe holding below 5°C when frequent access is required.

CODE	CP814 (20 x 36 CAMCHILLER)
FITS INTO FOOD BOXES	12189CW, 12189P, 12186CW, 12186P
DIMENSIONS L x W x H	35,56 x 20,32 x 3,8 cm

Case Pack: 1 Color: Cold Blue (159).



STORESAFE® FOOD ROTATION LABELS

- Label and adhesive dissolve in less than 30 seconds.
- Run under hot or cold water or through the dishwasher.
- Safe for all sewer and septic systems and will not build up in drains.
- Withstands freezing temperatures as low as -40°C.
- Withstands high heat temperatures up to 93°C for 4 hours.
- Microwave safe.
- Leaves behind no sticky residue which can be a breeding ground for bacteria.
- Assists in a proper First In First Out (FIFO) food storage system.
- 100% dissolvable and biodegradable.

Label color: White (148).
 *Available for ordering in cases only.
 No broken cartons.
 100% biodegradable. FDA approved material.



Eliminates sticky residue and prevents cross contamination! No more scraping!



Dissolves completely off all containers when placed through dishwasher or under running water.

STOCK PRODUCTS & COLORS AVAILABLE IN OUR EUROPEAN WAREHOUSE

1252SLB250, 1252SLINB250, 23SLINB6250, 23SLB250, 23SLINB250

Retail Blister Pack

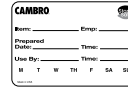

CASE CODE	23SL
LABEL SIZE	5 x 7,6 cm
CASE PACK	20 rolls, 100 labels per roll

StoreSafe Label Blister Pack is covered by U.S. Patent 690,589 S.



Bulk Dispenser Pack – Half Size Labels



CASE CODE	1252SLB250	1252SLINB250
LABEL SIZE	3 x 5 cm	3 x 5 cm
CASE PACK	24 rolls, 250 labels per roll	24 rolls, 250 labels per roll

Bulk Dispenser Pack

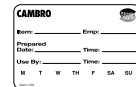
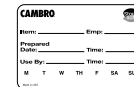

CASE CODE	23SLB250	23SLB6250
LABEL SIZE	5 x 7,6 cm	5 x 7,6 cm
CASE PACK	24 rolls, 250 labels per roll	6 rolls, 250 labels per roll

Bulk Dispenser Pack – Blank Labels

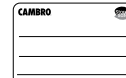
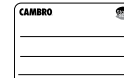

CASE CODE	23SLINB250	23SLINB6250
LABEL SIZE	5 x 7,6 cm	5 x 7,6 cm
CASE PACK	24 rolls, 250 labels per roll	6 rolls, 250 labels per roll

Laser Sheet



BOX CODE	SLL30 (Avery® 5160)
LABEL SIZE	2,54 x 6,35 cm
CASE PACK	100 sheets, 30 labels per sheet 21,6 x 27,9 cm sheet size



CAMWEAR® GASTRONORM FOOD PANS



CLEARLY THE BEST

Store, transport, and serve all in one pan. Precisely designed by Gastronorm GN specifications, with a large radius bottom to reduce food waste.

Camwear GN pans are not recommended for steam table or microwave use. See H-Pan™ section for high heat applications.



UNBREAKABLE

The Gastronorm Food Pan is virtually unbreakable for a lasting storage solution.

CLARITY

Check contents while reducing handling and cross contamination.



HOT or NOT

Withstands a wide range of temperatures: -40°C to 99°C



NO REACTION
Polycarbonate Food Pans will not react or stain with acids or oils.

COLD TEST



STAINLESS
STEEL PAN

CAMWEAR
FOOD PAN

CAMWEAR® GASTRONORM FOOD PANS SIZE, & ORDERING INFORMATION

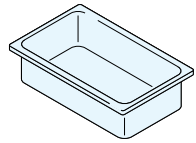

CONFIGURATIONS	PAN CODE	PAN DEPTH	APPROXIMATE CAPACITY
GN 1/1 32,5 x 53 cm	12CW	6,5 cm	8,5 L
	14CW	10	13
	16CW	15	19,5
	18CW	20	25,6
	10CWD	—	Drain shelf

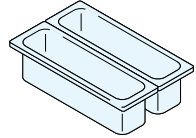

GN 1/2 Long 16,2 x 53 cm	22LPCW	6,5	3
	24LPCW	10	5
	20LPCWD	—	Drain shelf

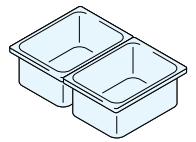

GN 1/2 26,5 x 32,5 cm	22CW	6,5	3,9
	24CW	10	5,9
	26CW	15	8,9
	28CW	20	11,7
	20CWD	—	Drain shelf

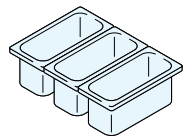

GN 1/3 17,6 x 32,5 cm	32CW	6,5	2,4
	34CW	10	3,6
	36CW	15	5,3
	38CW	20	6,9
	30CWD	—	Drain shelf

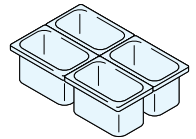

GN 1/4 16,2 x 26,5 cm	42CW	6,5	1,7
	44CW	10	2,5
	46CW	15	3,7
	40CWD	—	Drain shelf

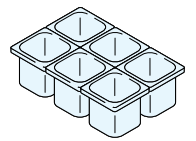

GN 1/6 16,2 x 17,6 cm	62CW	6,5	1
	64CW	10	1,5
	66CW	15	2,2
	60CWD	—	Drain shelf

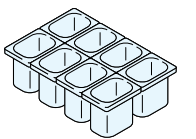

GN 1/8 16,12 x 13,17 cm	82CW*	6,5	0,7
	84CW	10	1
	86CW	15	1,5
	80CWD	—	Drain shelf

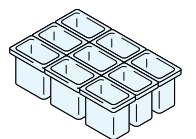

GN 1/9 10,8 x 17,6 cm	92CW	6,5	0,57
	94CW	10	0,85
	96PCW	15	1,4
	90CWD	—	Drain shelf

Case Pack: 6

Colors: Clear (135), White (148), Black (110). *82CW is not available in Black (110). 18CW and 28CW available in Clear (135) only.

Drain Shelf Color: Clear (135).

Colander Color: Clear (135).

All Camwear GN Food Pans are made of FDA approved materials. All Camwear GN Food Pans are designed to CEN Gastronorm Standard EN 631-1.

Personalization available on non-food contact areas only. See cresting section for information and ordering.



STOCK PRODUCTS & COLORS AVAILABLE IN OUR EUROPEAN WAREHOUSE

10CWD, 18CW, 20CWD, 28CW, 30CWD, 40CWD, 60CWD, 90CWD, 92CW, 96CW: (135)
12CW, 14CW, 16CW, 22LPCW, 24LPCW, 22CW, 24CW, 26CW, 32CW, 42CW, 44CW, 46CW, 62CW, 94CW: (135), (110)
36CW, 64CW, 66CW: (135), (110), (148)
34CW, 38CW: (135), (148)

Drain Shelves

- Keeps products out of liquids and promotes drainage.
- Available for all food pan sizes.



96PCW

CAMWEAR® LID SIZES & ORDERING INFORMATION



Flat Cover

Available in all pan sizes.



Cover with Handle

Deep molded handle provides secure grip and also includes a peg hole for sanitary drying. Available in black to help block light, reducing discoloration of meats and cheeses.



Notched Cover with Handle

Notched cover allows utensils to remain in pan and off of potentially contaminated counters. Includes peg hole for sanitary drying.



Seal Cover

Designed to fit Camwear and translucent food pans, Seal Covers feature an inner seal that provides superior spill resistance and extends shelf life up to 3 days.



FlipLid®

Flip up lid to easily access contents. Food can be held without getting dried out, increasing yields. Reduces points of cross contamination.



Notched FlipLid

Flip Lid with notch to rest spoon in contents with lid closed.



GripLid®

Molded-in polyurethane gasket on the lid grips the side of the food pan airtight, reducing spills and points of cross contamination.

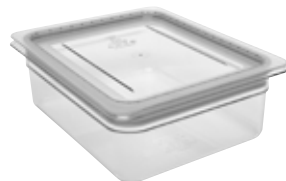

FITS PANS	LID CODE	DESCRIPTION
GN 1/1 32,5 x 53 cm	10CWC	Flat cover
	10CWCH*	Cover with handle
	10CWCHN*	Notched cover with handle
	10CWGL	GripLid
	10PPCWSC	Seal cover
GN 1/2 Long 16,2 x 53 cm	20LPCWC	Flat cover
GN 1/2 26,5 x 32,5 cm	20CWC	Flat cover
	20CWCH*	Cover with handle
	20CWCHN*	Notched cover with handle
	20CWL	FlipLid
	20CWLN	Notched FlipLid
	20CWGL	GripLid
	20PPCWSC	Seal cover
GN 1/3 17,6 x 32,5 cm	30CWC	Flat cover
	30CWCH*	Cover with handle
	30CWCHN*	Notched cover with handle
	30CWL	FlipLid
	30CWLN	Notched FlipLid
	30CWGL	GripLid
	30PPCWSC	Seal cover
GN 1/4 16,2 x 26,5 cm	40CWC	Flat cover
	40CWCH*	Cover with handle
	40CWCHN*	Notched cover with handle
	40PPCWSC	Seal cover
	GN 1/6 16,2 x 17,6 cm	60CWC
60CWCH*		Cover with handle
60CWCHN*		Notched cover with handle
60CWL		FlipLid
60CWLN		Notched FlipLid
60CWGL		GripLid
60PPCWSC		Seal cover
GN 1/8 16,12 x 13,17 cm	80CWC	Flat cover
	80CWCH	Cover with handle
	80CWCHN	Notched cover with handle
	80PPCWSC	Seal cover
GN 1/9 10,8 x 17,6 cm	90CWC	Flat cover
	90WCN	Flat notched cover
	90CWL*	FlipLid cover
	90CWLN*	Notched FlipLid cover
	90PPCWSC	Seal cover

Case pack for all lids: 6 *Includes peg hole.

Color: Clear (135).
Seal Cover Color: Translucent (190).
Cover with Handle Colors: Clear (135), Black (110).

FlipLids are covered by U.S. Patent Des. 420,849, 422,838 & 427,012. GripLids are covered by U.S. Patent D 446,076 & Utility Patent 6,273,288 B1.

STOCK PRODUCTS & COLORS AVAILABLE IN OUR EUROPEAN WAREHOUSE

10PPCWSC, 20PPCWSC, 30PPCWSC, 40PPCWSC, 60PPCWSC, 90PPCWSC: (190)
 10CWC, 10CWCH, 10CWCHN, 10CWGL, 20LPCWC, 20CWC, 20CWCH, 20CWCHN, 20CWGL, 30CWC,
 30CWCH, 30CWCHN, 30CWGL, 40CWC, 40CWCH, 60CWC, 60CWCH, 60CWCHN, 60CWGL, 90CWC: (135)

Personalization available on non-food contact areas only. See cresting section for information and ordering.



CAMWEAR® COLANDER PANS



- Rinse, drain and store all in one pan.
- Liquids drain easily into the food pan below for enhanced food quality and reduced handling.
- Colanders simply lift out of the food pan for safe and quick disposal of liquids.
- Ideal for prepped produce, storing seafood on ice, and defrosting and storing meats and poultry.
- Camwear flat covers, covers with handles and notched covers with handles fit on pans with colanders.

Colander Pans are covered by U.S. Patent D 569,169 S.



Drain hole dimension: 6 mm

13CLRCW with 14CW Food Pan



Rinse



Drain



Store

CONFIGURATIONS	PAN CODE	COLANDER DEPTH	FITS CAMWEAR PAN DEPTH*
GN 1/1 32,5 x 53 cm	13CLRCW	7,6 cm	10 cm
	15CLRCW	12,7	15
GN 1/2 26,5 x 32,5 cm	23CLRCW	7,6	10
	25CLRCW	12,7	15
GN 1/3 17,6 x 32,5 cm	33CLRCW	7,6	10
	35CLRCW	12,7	15
GN 1/6 16,2 x 17,6 cm	63CLRCW	7,6	10
	65CLRCW	12,7	15



Case Pack for all Pans: 6 *Fits this pan depth & deeper. Lids listed on previous page.

H-PAN™ HIGH HEAT FOOD PANS



Store, transport, and serve all in one pan. Precisely designed by Gastronorm GN specifications, with a large radius bottom to reduce food waste.



191°C

Withstands temperatures from -40°C to 191°C

-40°C

ONE PAN THAT DOES IT ALL



GOES FROM...



PREP



OVEN



FREEZER



MICROWAVE



STEAM TABLE



Pan edges are COOL to the touch for safe handling

PANS STACK

GASTRONORM HIGH HEAT H-PANS™

SIZES & ORDERING INFORMATION

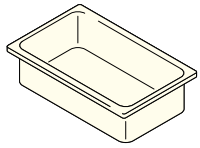

CONFIGURATIONS	PAN CODE	PAN DEPTH	APPROXIMATE CAPACITY
GN 1/1 32,5 x 53 cm	12HP	6,5 cm	8,5 L
	14HP	10	13
	16HP	15	19,5
	10HPD	—	Drain shelf

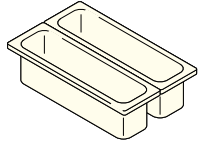

GN 1/2 Long 16,2 x 53 cm	22LPHP	6,5	3
	24LPHP	10	5
	20LPHPD	—	Drain shelf

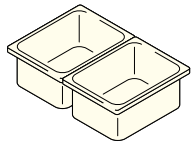

GN 1/2 26,5 x 32,5 cm	22HP	6,5	3,9
	24HP	10	5,9
	26HP	15	8,9
	20HPD	—	Drain shelf

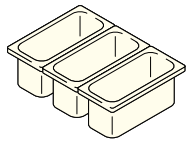

GN 1/3 17,6 x 32,5 cm	32HP	6,5	2,4
	34HP	10	3,6
	36HP	15	5,3
	30HPD	—	Drain shelf

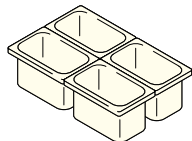

GN 1/4 16,2 x 26,5 cm	42HP	6,5	1,7
	44HP	10	2,5
	46HP	15	3,7
	40HPD	—	Drain shelf

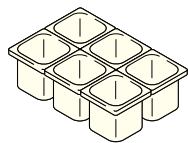

GN 1/6 16,2 x 17,6 cm	62HP	6,5	1
	64HP	10	1,5
	66HP	15	2,2
	60HPD	—	Drain shelf

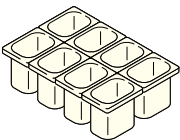

GN 1/8 16,12 x 13,17 cm	82HP	6,5	0,7
	84HP	10	1
	86HP	15	1,5
	80HPD	—	Drain shelf

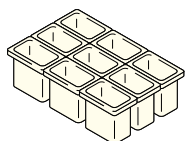

GN 1/9 10,8 x 17,6 cm	92HP	6,5	0,57
	94HP	10	0,85
	96PHP	15	1,4
	90HPD	—	Drain shelf

Case Pack: 6

Colors: Amber (150), Black (110).
Drain Shelf Color: Amber (150).

H-Pans are made of FDA approved materials and are designed to CEN Gastronorm Standard EN 631-1. Amber color may vary.

Personalization available on non-food contact areas only. See cresting section for information and ordering.

Microwave safe.

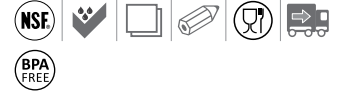

Drain Shelf

- Supports product and promotes drainage.
- Available to fit all food pan sizes.



86HP
Shown with Optional Drain Shelf.

STOCK PRODUCTS & COLORS AVAILABLE IN OUR EUROPEAN WAREHOUSE

14HP, 16HP, 34HP, 30HPD,
36HP, 64HP, 66HP: (150)
22LPHP, 24LPHP: (110)
12HP, 22HP, 24HP, 26HP: (110), (150)

LIDS FOR GASTRONORM H-PAN™ FOOD PANS AND ORDERING INFORMATION



FITS PANS	LID CODE	DESCRIPTION
GN 1/1 32,5 x 53 cm	10HPC*	Flat cover
	10HPCH*	Cover with handle
	10HPCHN*	Notched cover w/handle
GN 1/2 Long 16,2 x 53 cm	20LPHPC	Flat cover
GN 1/2 26,5 x 32,5 cm	20HPC*	Flat cover
	20HPCH*	Cover with handle
	20HPCHN*	Notched cover w/handle
	20HPL	FlipLid
	20HPLN	Notched FlipLid
GN 1/3 17,6 x 32,5 cm	30HPC*	Flat cover
	30HPCH*	Cover with handle
	30HPCHN*	Notched cover w/handle
	30HPL	FlipLid
	30HPLN	Notched FlipLid

Notched FlipLid®

Flip Lid with notch to rest spoon in contents with lid closed.

GN 1/4 16,2 x 26,5 cm	40HPC*	Flat cover
	40HPCH*	Cover with handle
	40HPCHN*	Notched cover w/handle
GN 1/6 16,2 x 17,6 cm	60HPC*	Flat cover
	60HPCH*	Cover with handle
	60HPCHN*	Notched cover w/handle
	60HPL	FlipLid
	60HPLN	Notched FlipLid
GN 1/8 16,12 x 13,17 cm	80HPC*	Flat cover
	80HPCH*	Cover with handle
	80HPCHN*	Notched cover w/handle



FlipLid®

Flip up lid to easily access contents. Food can be held without getting dried out, increasing yields.



Flat Cover

Available in all pan sizes.



Cover with Handle

Deep molded handle gives secure grip.

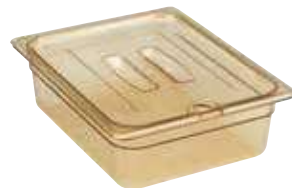

Notched Cover with Handle

Easy access for ladles or spoons.

90HPC* Flat cover

Case pack: 6 *Includes peg hole.

Color: Amber (150).
Amber color may vary.

FlipLids are covered by U.S. Patent
D 420,849, D 422,838, D 427,012 &
D 6,273,288 B1.

Microwave safe.



STOCK PRODUCTS & COLORS AVAILABLE IN OUR EUROPEAN WAREHOUSE

10HPC, 10HPCH, 20HPC, 20HPCH, 30HPC,
30HPCH, 30HPCHN, 60HPC, 60HPCH,
60HPCHN: (150)

H-PAN™ HIGH HEAT COLANDER PANS



- Colanders drain liquids and grease away from hot foods, improving food quality.
- Ideal for reheating in microwaves and holding applications such as steam tables and buffet lines.
- Reduces handling and improves food safety.
- H-Pan High Heat Flat Covers, Covers with Handles and Notched Covers with Handles fit on pans with colanders.



Microwave/Steam



Hold Hot Foods



Drain

CONFIGURATIONS	PAN CODE	COLANDER DEPTH	FITS H-PAN DEPTH*
GN 1/1 32,5 x 53 cm	13CLRHP	7,6 cm	10 cm
	15CLRHP	12,7	15
GN 1/2 26,5 x 32,5 cm	23CLRHP	7,6	10
	25CLRHP	12,7	15
GN 1/3 17,6 x 32,5 cm	33CLRHP	7,6	10
	35CLRHP	12,7	15
GN 1/6 16,2 x 17,6 cm	63CLRHP	7,6	10
	65CLRHP	12,7	15

Case Pack for all Pans: 6 *Fits this pan depth & deeper. Lids listed on previous page.



HIGH HEAT H-PAN™ WITH HANDLE(S)

- Flat base to maximize contact with heating element.
- High Heat Material withstands temperatures from -40° to 190°C.
- Fits all leading manufacturer's hot holding bins, including single-sided and pass-through models.
- Reinforced textured handle design with finger grip feature for a secure grasp.
- Handle designed with drain holes to avoid water build-up after warewashing process.
- Two handles allow employees to reach the pan from either side of the unit for safe handling.
- Can be used with high heat lids and drain shelves.

Color: Amber (150).



STOCK PRODUCTS & COLORS AVAILABLE IN OUR EUROPEAN WAREHOUSE

32HP1H, 32HP2H: (150)



34HP2H



32HP1H

CONFIGURATIONS	PAN CODE	DESCRIPTION	PAN DEPTH
1/3 17,6 x 32,5 cm	32HP1H	Single Handle	6,5 cm
	32HP2H	Double Handle	6,5
	34HP1H	Single Handle	10
	34HP2H	Double Handle	10

Case Pack: 6 Color: Amber (150).

High Heat Flat Cover, Cover with Handle and Notched Cover with Handle fit on pan.

Full size 6,5 cm deep food pan with handles fits all leading manufacturers' hot holding bins.



12HPH

CONFIGURATIONS	PAN CODE	PAN DEPTH	APPROX. CAPACITY
1/1 32,5 x 53 cm	12HPH	6,5 cm	8,42 L

Case Pack: 6 Color: Amber (150). Lids listed on previous page.

TRANSLUCENT POLYPROPYLENE GASTRONORM FOOD PANS



- An economical choice for storing food.
- Translucent polypropylene material provides content visibility and high chemical resistance.
- Withstands temperature ranges from -40° to 70°C.
- Meets Gastronorm GN food pan specifications EN-631-1.
- Non-stick smooth interior surface promotes easy cleaning.

Color: Translucent (190).

 Graduation marks and capacities are approximate.

 Translucent food pans are made of FDA approved materials.

 Translucent food pans interstack with other Cambro food pans.

 Translucent pans are not designed for steam table use.



Ideal for transporting in Cambro top loading carriers. (UPC100, UPCS140, 100MPC, UPC140, UPCS160, 240MPC, UPC160, EPP160SW, EPP180SW, EPP260SW, EPP280SW)



Seal covers protect food quality while eliminating the expense of plastic wrap.



Uniform 1,27 cm flange width ensures the right fit in prep tables and food bars.



Use Cambro StoreSafe® food rotation labels on translucent food pans to manage inventory and reduce waste.

POLYPROPYLENE GASTRONORM COLANDER PANS

- Rinse, drain and store all in one pan.
- Liquids drain easily into the food pan below for enhanced food quality and reduced handling.
- Translucent Cover w/Handle and Notched Cover with Handle fit on pans with colanders.
- Drain hole diameter is approximately 6 mm.

Color: Translucent (190).

 Translucent colander pans are made of FDA approved materials.

 Translucent pans are not designed for steam table use.



CONFIGURATIONS	PAN CODE	COLANDER DEPTH	FITS POLYPROPYLENE PAN DEPTH*
GN 1/3 17,6 x 32,5 cm	33CLRPP 35CLRPP	7,6 cm 12,7	10 cm 15
GN 1/6 16,2 x 17,6 cm	63CLRPP 65CLRPP	7,6 12,7	10 15

Case Pack for all Pans: 6 *Fits this pan depth & deeper.
 Lids listed on following page.

TRANSLUCENT FOOD PANS



Color: Translucent (190).

All Translucent Gastronorm Food Pans are made of FDA approved materials.

All polypropylene GN Food Pans are designed to CEN Gastronorm Standard EN 631-1.



STOCK PRODUCTS & COLORS AVAILABLE IN OUR EUROPEAN WAREHOUSE

10PPD, 12PP, 14PP, 16PP, 18PP, 20PPD, 22PP, 24PP, 26PP, 28PP, 30PPD, 32PP, 34PP, 36PP, 38PP, 40PPD, 42PP, 44PP, 46PP, 60PPD, 62PP, 64PP, 66PP, 90PPD, 92PP, 94PP: (190)

Drain Shelves

- Keeps products out of liquids and promotes drainage.
- Available for all pan sizes.



CONFIGURATIONS	PAN CODE	PAN DEPTH	APPROXIMATE CAPACITY
GN 1/1 32,5 x 53 cm	12PP*	6,5 cm	8,5 L
	14PP	10	13
	16PP	15	19,5
	18PP*	20	25,6
	10PPD	—	Drain shelf

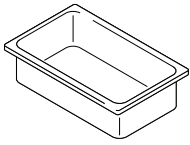

GN 1/2 17,6 x 32,5 cm	22PP*	6,5	3
	24PP	10	5,9
	26PP	15	8,9
	28PP*	20	11,7
	20PPD	—	Drain shelf

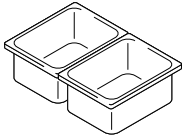

GN 1/3 17,6 x 32,5 cm	32PP	6,5	2,4
	34PP	10	3,6
	36PP	15	5,3
	38PP*	20	6,9
	30PPD	—	Drain shelf

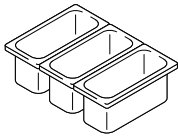

GN 1/4 16,2 x 26,5 cm	42PP	6,5	1,7
	44PP	10	2,5
	46PP	15	3,7
	40PPD	—	Drain shelf

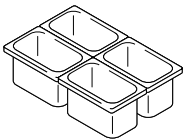

GN 1/6 16,2 x 17,6 cm	62PP	6,5	1
	64PP	10	1,5
	66PP	15	2,2
	60PPD	—	Drain shelf

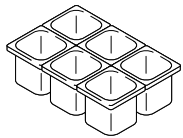

GN 1/9 10,8 x 17,6 cm	92PP	6,5	0,57
	94PP	10	0,85
	90PPD	—	Drain shelf

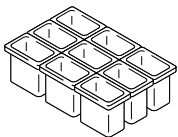

Case Pack: 6 *Only available from Cambro European Logistics (CEL), Germany and Cambro Özyay Turkey.

TRANSLUCENT FOOD PAN LIDS



Seal Cover

Designed to fit Camwear® and translucent food pans, Seal Covers feature an inner seal that provides superior spill resistance and extends shelf life up to 3 days. Available for all food pan sizes.



FITS PAN	LID CODE	DESCRIPTION
GN 1/1 32,5 x 53 cm	10PPCH	Cover with handle
	10PPCWSC	Seal cover

GN 1/2 26,5 x 32,5 cm	20PPCH	Cover with handle
	20PPCWSC	Seal cover

Cover with Handle

Deep molded handle gives secure grip. Available for all food pan sizes except 1/9.



GN 1/3 (17,6 x 32,5 cm)	30PPCH	Cover with handle
	30PPCHN	Notched cover w/handle
	30PPCWSC	Seal cover

GN 1/4 16,2 x 26,5 cm	40PPCH	Cover with handle
	40PPCWSC	Seal cover

Notched Cover with Handle

Easy access for ladles or spoons. Available for 1/3 and 1/6 food pans.



GN 1/6 16,2 x 17,6 cm	60PPCH	Cover with handle
	60PPCHN	Notched cover w/handle
	60PPCWSC	Seal cover

Flat Cover

Only available for 1/9 food pans.



GN 1/9 10,8 x 17,6 cm	90PPC	Flat cover
	90PPCWSC	Seal cover

Case Pack: 6

Color: Translucent (190).

All Translucent Gastronorm Food Pan lids are made of FDA approved materials.

All polypropylene GN Food Pans are designed to CEN Gastronorm Standard EN 631-1.



STOCK PRODUCTS & COLORS AVAILABLE IN OUR EUROPEAN WAREHOUSE

20PPCH, 30PPCH, 40PPCH, 60PPCH, 10PPCWSC, 20PPCWSC, 30PPCWSC, 40PPCWSC, 60PPCWSC, 90PPCWSC: (190)





COLDVEST® GASTRONORM FOOD PANS, CROCKS, COVERS & PUMPS

- Keeps contents chilled at or below HACCP guidelines of 4°C without the use of messy ice.
- Freeze upside down for eight hours or overnight before filling with pre-chilled product.
- Half and third-size pans hold contents cold for up to eight hours. Sixth size pans and crocks hold contents cold for up to six hours.
- Conforms to Gastronorm exterior dimensions to fit standard food bars or make tables.
- Stackable to save space when freezing and storing.
- Can be used for direct food contact with all types of food products.

Colors: Black (110), White (148).
Flat Cover Color: Clear (135).
Seal Cover Color: White (148).
Pump with Cover Color: Clear (135).

Suggested holding times are based on tests with ambient room conditions of up to 23°C.

ColdFest is covered under U.S. Patent D 419,364.

*Pumps and round covers not NSF listed.

All ColdFest GN Food Pans are designed to CEN Gastronorm Standard EN 631-1.



STOCK PRODUCTS & COLORS AVAILABLE IN OUR EUROPEAN WAREHOUSE

66CF: (110)
CFR18: (110), (148)
60CFC: (135)



Ideal for use with Cambro Versa Food Bars® to keep perishable items chilled.

Pans / Crock



CODE	26CF‡	36CF‡	66CF‡	CFR18‡
CONFIGURATIONS	GN 1/2 – 26,5 x 32,5 cm	GN 1/3 – 17,6 x 32,5 cm	GN 1/6 – 16,2 x 17,6 cm	ø 17,3 cm
DEPTH	15 cm	15 cm	15 cm	17 cm
APPROX. CAPACITY	6 L	3,5 L	1,4 L	1,6 L

Case Pack: 1



ColdFest Food Pans are made with high-impact resistant ABS shells and non-toxic refrigerant gel cores.

Covers



CODE	20CFC	30CFC	60CFC	CFRC18*	CFRSC18
DESCRIPTION	Flat cover	Flat cover	Flat cover	Flat cover	Seal cover
FITS COLDVEST	GN 1/2	GN 1/3	GN 1/6	Crock	Crock

Case Pack: 2

Pumps with Clear Covers



CODE	CFPSRC10*	CFPMRC10*	CFPFR10*
DESCRIPTION	Standard pump for 29,5 mL portions	Maxi pump for chunky condiments	Fixed nozzle pump for controlled dispensing
DIMENSIONS W x D x H	18,4 x 22,8 x 28,5 cm	18,4 x 26 x 31,4 cm	18,4 x 29,5 x 29,8 cm

Case Pack: 1



PIZZA DOUGH BOXES



DB18263P

Polypropylene

- Ideal for storing, transporting, proofing and cooling dough.
- Lightweight, durable, and break resistant.
- Chemical resistant won't absorb odors and is easy to clean.
- Boxes nest tightly together to keep out dirt and contaminants, extending product freshness.

- Each box acts as a tight lid for the box below, reducing the need and expense of covers.
- Withstands temperatures from -40° to 70°C.
- Cover can be used as an 46 x 66 cm tray.
- Available in 7,6 cm depth only.

Color: White (148).

Camwear & Polypropylene dough boxes do not inter stack.

CD1826PDB Color: Coffee Beige (157), Brown(131), Black (110), Slate Blue (401), Grey (180).

*Polypropylene dough boxes are safe for use in high temperature dishwashers.

Camdolly Caster: 12,7 cm Casters: 2 fixed, 2 swivel, 1 with brake.



CD1826PDB

Weight Capacity: 136 kg



Camwear®

- Prevents crusting to increase the storage life of dough.
- Virtually unbreakable Camwear construction is reinforced on all sides.
- Boxes won't bend or lose their shape.

- Withstands temperatures from -40° to 99°C.
- Available in 7,62 and 15,24 cm depths.



DB18266CW

DB18263CW

STOCK PRODUCTS & COLORS AVAILABLE IN OUR EUROPEAN WAREHOUSE

DB18263P, DB18263CW: (148)

CODE	OUTSIDE DIMENSIONS	INSIDE DIMENSIONS
Polypropylene Pizza Dough Box		
DB18263P‡	46 x 66 x 7,6 cm	40,6 x 60,9 cm
Polypropylene Cover		
DBC1826P‡	46 x 66	—
Camwear Pizza Dough Boxes		
DB18263CW	46 x 66 x 7,6	40,6 x 60,9
DB18266CW	46 x 66 x 15,3	40,6 x 60,9
Camwear Cover		
DBC1826CW	46 x 66	—
Case Pack: 6 Color: White (148).		
Camdolly® For Pizza Dough Boxes		
CD1826PDB**	50,5 x 71 x 26	44,5 x 64,5
Case Pack: 1 **Optional straps (400STP or UTHSTP) sold separately.		



INGREDIENT BINS AND CAMWEAR® DRY SCOOPS

Ingredient Bins

- Store bulk dry ingredients such as flour and grain.
- Hygienic clear sliding lid reduces handling and allows for quick content identification.
- Bin made of FDA-accepted material so no liners are needed.
- Designed to fit under standard work tables.

7,6 cm Casters: 2 rear fixed, 2 front swivel.

Color: White (148).

Scoops sold separately.

IBSH24 Scoop Holder comes with IBS20, IBS27 and IBSF27 Ingredient Bins only.



STOCK PRODUCTS & COLORS AVAILABLE IN OUR EUROPEAN WAREHOUSE

IBS20, IBS27, IBS37: (148)



IBSF27



IBSH24

Holder for IBS20, IBS27 & IBSF27

CAPACITY: Up to 28,35g



CODE	DIMENSIONS W x L x H	LIQUID CAPACITY	LID TYPE	DRY CAPACITY (SUGAR)	DRY CAPACITY (FLOUR)
IBS20	33 x 75 x 71 cm	81 L	Two Piece Sliding Lid	77 kg	63 kg
IBS27	42 x 75 x 71	102	Two Piece Sliding Lid	103	68
IBS37	55 x 75 x 71	140	Two Piece Sliding Lid	143	102
IBSF27	33 x 76,5 x 72,5	102	Two Piece Sliding Lid	98	68
IB32	56 x 61 x 58,5	121	Single Flat Lid	98	73
IB36	39 x 75 x 74	129	Single Flat Lid	114	82
IB44	47 x 75 x 74	161	Single Flat Lid	145	104

Case Pack: 1

Camwear Dry Scoops

- Virtually unbreakable Camwear will not dent, chip or rust.
- Molded-in sure grip handle includes a hole for hanging.
- Ideal for use with Cambro Ice Caddies and Ingredient Bins.

Color: Clear (135).

Personalization not available.



STOCK PRODUCTS & COLORS AVAILABLE IN OUR EUROPEAN WAREHOUSE

ALL SCOOPS: (135)



CODE	APPROX. CAPACITY	CASE PACK
SCP6CW	170 g	12
SCP12CW	340	12
SCP24CW	680	12
SCP64CW	1814	6

SOAK AND BRINE TANK AND CAMCRISPER®



Soak and Brine Tank

- Designed for complete submersion of meats or poultry in brining solution for enhanced moisture retention, texture and flavor.
- Can also be used as a pre-soak tank for smallwares and dishes in sanitation solution to help reduce labor in pre-scrubbing.
- Clear sliding lid always stays on to help reduce the risk of cross-contamination.
- Withstands temperatures from -40° to 70°C.

7,6 cm Casters: 2 rear fixed, 2 front swivel.

Colors: White (148), Yellow (229).
Cover Color: Clear (135).

Some assembly required.



Maneuverable drain elbow can be positioned in any direction as needed. Use with or without drain hose based on available access to floor drain.

Tank drains easily in 4 minutes when completely full and features an easy to turn 45° ball valve.

Maneuverable drain elbow and clear hose allow drainage even with hard to access drains.

CODE	DIMENSIONS W x L x H	CAPACITY	CUBIC METER
IBSD37	54,6 x 74,9 x 71,7 cm	140 L	0,14

Case Pack: 1

Camcrisper

- A self-contained system for brining or storing, washing and transporting bulk produce.
- Prevents cross contamination and minimizes unnecessary handling.
- Transfer dry produce out of cartons into bin, cover and roll into cooler for safe storage.
- Wash and rinse produce for easy and safe prep.

7,6 cm Casters: 2 rear fixed, 2 front swivel.

Color: White (148).
Cover Color: Clear (135).



**STOCK PRODUCTS & COLORS
AVAILABLE IN OUR EUROPEAN
WAREHOUSE**

CC32: (148)



CODE	DIMENSIONS W x L x H	CAPACITY	CUBIC METER	LOAD CAPACITY
CC32	56 x 61 x 58,5 cm	121 L	0,123	24 lettuce heads (unfinished) 42 lettuce heads (finished)

Case Pack: 1

HIGH HEAT MEASURING CUPS AND CAMWEAR® MEASURING CUPS



High Heat Measuring Cups and Cover

- Use to heat liquids or sauces in the microwave, collect hot water from a dispenser, fill steam tables or chafing dishes or rehydrate food products.
- Withstands temperatures ranging from -40° to 190°C.
- Will not crack or shatter from regular use with hot liquids/ ingredients.
- Molded-in standard and metric graduations ensure accuracy and will hold up to the rigors of foodservice.

- Molded-in handle is positioned for both comfort and safety, and stays cool to the touch out of the microwave or oven.
- Optional Splatter-Proof Cover fits both 2 and 4 L measuring cups.

Color: Amber (150).



STOCK PRODUCTS & COLORS AVAILABLE IN OUR EUROPEAN WAREHOUSE

200MCH, 400MCH, MCCH: (150)



Cups shown with Optional Universal Cover.

CODE	DESCRIPTION	DIMENSIONS H x DIA.
200MCH	2 L Measuring Cup	16,2 x 19,4 cm
400MCH	4 L Measuring Cup	26,4 x 19,4
MCCH	Universal Cover (fits both cups)	19 x 2,4

Case Pack: 1

Camwear Liquid Measuring Cups

- Externally marked graduations are molded in and imprinted in red for American standard and blue for metric for easy measurement.
- Durable, virtually unbreakable Camwear will not dent, ensuring an accurate measurement every time.
- Molded-in handle will not break off.

Color: Clear (135).

Personalization available on non-food contact areas only. See cresting section for information and ordering.



STOCK PRODUCTS & COLORS AVAILABLE IN OUR EUROPEAN WAREHOUSE

100MCCW, 200MCCW, 400MCCW: (135)

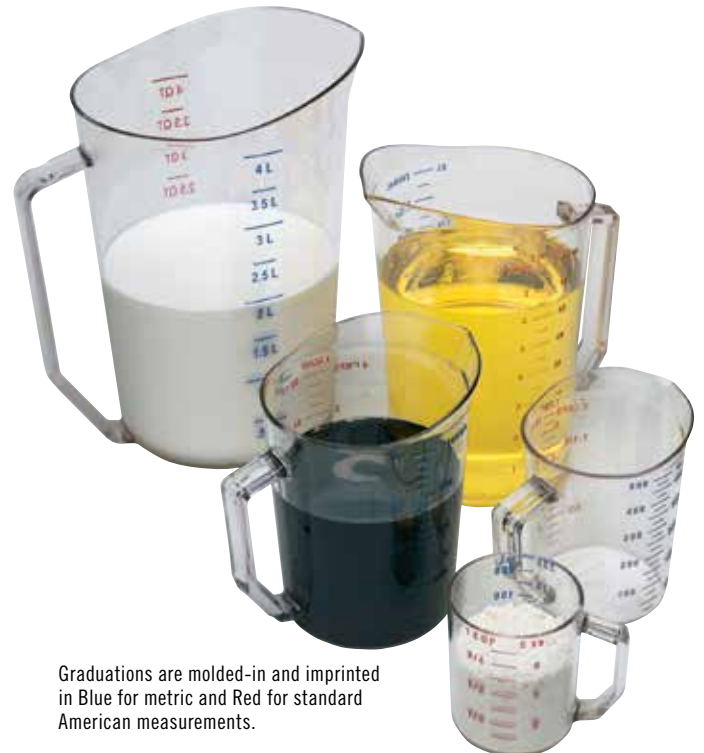

Graduations are molded-in and imprinted in Blue for metric and Red for standard American measurements.

CODE	CAPACITY	CASE PACK
25MCCW	225 mL (dry measure)	12
50MCCW	0,5 L	12
100MCCW	1	12
200MCCW	2	12
400MCCW	4	1

CAMWEAR® DINNERWARE

5 5 YEAR PRORATED WARRANTY AGAINST BREAKAGE

- Durable Camwear resists stains, odors and scratches.
- Textured surface on salad and dinner plates for long wear.
- Ideal for schools, cafeterias, day care centers and healthcare facilities.
- Mug and stacking cup can be personalized.

Not recommended for microwave use.



Oval Platters & Compartment Plates



CODE	90SPCW	120CWP	93CW	HK93BCW
DIAMETER	22,9 x H 4 cm	30,5 x 22,9 cm	22,9 cm	24,1 cm
DESCRIPTION	Round, soup bowl	Oval, narrow rim	Narrow rim	Narrow rim
CASE PACK	48	24	48	12

*HK93BCW is available in Beige (133) only. Not recommended for microwave use.

STOCK PRODUCTS & COLORS AVAILABLE IN OUR EUROPEAN WAREHOUSE

90SPCW, 10CWNR, 9CWNR, 825CWNR, 50CW, 60CW, 75CW: (148), (401)
 96CW: (148), (401)
 10CWL: (135)
 725CWNR, 65CWNR, 10CW, 45CW, 100CW, 150CW: (148)
 45CW, 100CW, 150CW: (148)

Plates



CODE	10CWNR	9CWNR	825CWNR	725CWNR	65CWNR	55CWNR
DIAMETER	25,4 cm	22,9 cm	21 cm	18,4 cm	16,5 cm	14 cm
DESCRIPTION	Narrow rim	Narrow rim	Narrow rim	Narrow rim	Narrow rim	Narrow rim
CASE PACK	48	48	48	48	48	48

Not recommended for microwave use.

Bowls



CODE	10CW*	10CWL	35CW	45CW	50CW	60CW	100CW	150CW
APPROX. CAPACITY	278 mL	—	252 mL	150 mL	452 mL	322 mL	370 mL	494 mL
DESCRIPTION	Square bowl	Lid for 10CW bowl	Bouillon	Fruit cup	Nappie bowl	Grapefruit bowl	Nappie bowl	Square bowl
CASE PACK	48	48	48	48	48	48	48	48
SHAPE	Square	Square	Round	Round	Round	Round	Round	Top/round bottom/square
OUTSIDE DIAMETER	10,2 x 10,2 cm	—	9,8 cm	11,7 cm	13,3 cm	15,2 cm	12,5 cm	Top: 13,3 cm Bottom: 6,4 x 6,4 cm
HEIGHT	4,8 cm	2,2 cm	5,4 cm	3,3 cm	5,4 cm	4 cm	4,3 cm	5,7 cm

Not recommended for microwave use. *Optional lid available.

Mug & Cup



CODE	75CW	96CW
APPROX. CAPACITY	239 mL	288 mL
DESCRIPTION	Stacking cup	Mug
CASE PACK	48	48
MAX DIA./HEIGHT	10,3* cm / 8 cm	10,6* cm / 9,5 cm
FULL SIZE CAMRACK®	16C414	16C414

*Maximum diameter includes handles.
 Not recommended for microwave use.

Heat Keepers



CODE	HK93CW	HK39
DESCRIPTION	3 compartment base and cover	Heat Keeper base and cover for 22,9 cm plate
CASE PACK	6	6

HK93CW is available in Beige (133).
 HK39 is available in Antique White (148).
 Not recommended for microwave use.

VERSA CAMCOVERS®

Serve hot food hot with the Versa Camcover, an elegant and efficient alternative to traditional metal covers.

- Microwave safe plate covers withstands temperatures up to 149°C*.
- Covers remain cool to the touch for easy handling.
- Lighter and quieter than metal covers.
- Elegant appearance without polishing.
- Keeps food warm longer than metal covers.

- Available in a variety of sizes in round and square.
- Made of fiberglass material.

Colors: Granite Gray (191), Antique Parchment (101).

*Can be used in heated carts.

Microwave safe.

For help selecting the correct size plate cover, refer to the Camcover Sizing Guide on our website at www.cambro.com. Or, send one of your plates to Cambro Customer Service for sizing.



CODE	INSIDE DIAMETER	OUTSIDE HEIGHT	CASE PACK
Square			
85SFVS	20,91 cm	7 cm	12
978SFVS	25,4	7	12
Round			
68VS	16,5	5,6	12
86VS	21	6,7	12
91VS	23,2	6,8	12
913VS	24,9	6,8	12
95VS	23,7	6,8	12
99VS	24,3	6,7	12
911VS	24,6	7	12
100VS	25,4	6,8	12
103VS	25,9	6,8	12
105VS	26,2	6,8	12
106VS	26,4	7,2	12
1010VS	27	6,8	12
1012VS	27,3	6,8	12
1014VS	27,6	6,8	12
116VS	28,9	8,1	12
120VS	30,5	7,3	12
124VS	31,1	7,3	12



CAMWEAR® CAMCOVERS®

- Food stays hot and appetizing without re-heating.
- Ideal for use in heated carts up to 99°C*.
- Made of durable Camwear, will not dent or scratch.
- Lightweight for quiet service.
- Saves on labor with no polishing required.

Colors: Clear (152), Amber (153), Beige (133), Silver (486).

MDCPC9CW Colors: Clear (135), Amber (153), Beige (133), Silver (486).

For help selecting the correct size plate cover, refer to the Camcover Sizing Guide on our website at www.cambro.com. Or, send one of your plates to Cambro Customer Service for sizing.

*Not recommended for microwave use.



STOCK PRODUCTS & COLORS AVAILABLE IN OUR EUROPEAN WAREHOUSE

9011CW, 1000CW, 1007CW, 1013CW, 1101CW: (152)

CODE	INSIDE DIAMETER	OUTSIDE HEIGHT	CASE PACK
Camwear Camcovers			
806CW	21,4 cm	6,8 cm	12
900CW	23,2	7	12
901CW	23,7	7,2	12
905CW	24,1	7,2	12
909CW	24,8	7	12
9011CW	25,4	7,3	12
9013CW	25,4	7	12
1000CW	25,9	6,8	12
1005CW	26,8	7,2	12
1007CW	27	7	12
1013CW	27,5	6,8	12
1101CW	27,9	6,8	12
1202CW	30,8	7	12
Camwear Low Profile Camcovers			
MDCPC9CW	23,2	5	12

PROMOTE YOUR BRAND – PERSONALIZED TABLE SERVICE AND FOOD STORAGE PRODUCTS

Personalize tumblers, barware, pitchers, decanters and dinnerware to promote a brand, business or enhance customer satisfaction. Use to identify inventory for multiple service locations. Personalize food storage products to identify contents, add fill lines with recipe instructions to ensure product quality and consistency. Personalized product orders are full case quantities only, no broken cartons.



Look for this icon that identifies items that can be personalized.

PAD PRINT PERSONALIZATION

- One color. Two color available for table service products only.
- Choose from 12 standard imprint colors.
- Print area is 6 mm to 10 cm, based on printable area specific to product. Order minimum 72 each.

PERSONALIZATION CHARGES

- Custom Personalization Plate Charge
- *** Net (one-time charge, billed on first purchase order)
- Set Up Charge
*** Net per order
- Color Imprint Charge
*** Net per side, per color

HOW TO ORDER A SAMPLE

- 1. Request a Sample**
Contact your local Cambro representative to complete and submit your sample request to Cambro. Form **MUST BE** submitted with artwork.
- 2. Artwork**
Must be ready to use, digital format only. Email to Cambro Representative or to Cambro at letsgetpersonal@Cambro.com. Title email subject with logo name. Provide contact info. If artwork is incomplete, graphic services are available for *** per hour. File Dimensions: 100% reproduction size, 300 dpi resolution. File Type: Adobe® Illustrator®, Photoshop®. File Format: jpeg, tiff, eps
- 3. Sample Turnaround**
7 – 10 business days from approval of artwork.
- 4. Sample Approval**
Approval form included with each sample. Form must be completed and faxed to Cambro prior to processing purchase order.
- 5. Sample Charge (net)**
*** per sample (charge billed on sample order, credited back on first purchase order).
- 6. Questions**
Contact Kristie Patterson at 714-230-4125 direct, 800-854-7631 Ext. 4125 or email kpatterson@Cambro.com.
***Contact your Cambro representative for pricing.



CHOOSE ONE OR TWO STANDARD IMPRINT COLORS

Due to the catalog printing process, the colors shown may not be exact.



CAMWEAR® PITCHERS

- Lightweight for easy handling.
- Exclusive ice-control contoured lip and pour spout reduce spills.
- Slotted base allows for complete and sanitary drying.

Color: Clear (135). P600CW is also available in Amber (153).

Capacities calculated to rim.

Personalization available. See cresting section for information, ordering and pricing.

PC34CW Stackable Pitcher is covered by the following U.S. Patent D 682,002 S.



STOCK PRODUCTS & COLORS AVAILABLE IN OUR EUROPEAN WAREHOUSE

P320CW, P34CW, P34LCW, P480CW, P600CW, P60CW, PL60CW, PE600CW, P64CW, PC64CW: (135)



P320CW, P480CW and P600CW

An industry standard. Broad base for stability, prevents tipping.



P320CW

CAPACITY: 0,95 L

HEIGHT WITH SPOUT: 17 cm

DIAMETER WITH HANDLE: 14,5 cm

Case Pack: 6



P480CW

CAPACITY: 1,4 L

HEIGHT WITH SPOUT: 20 cm

DIAMETER WITH HANDLE: 16 cm

Case Pack: 6



P600CW

CAPACITY: 1,8 L

HEIGHT WITH SPOUT: 20,5 cm

DIAMETER WITH HANDLE: 17 cm

Case Pack: 6



P60CW

CAPACITY: 1,8 L

HEIGHT WITH SPOUT: 23 cm

DIAMETER WITH HANDLE: 18,5 cm

Case Pack: 6



PL60CW

CAPACITY: 1,8 L

HEIGHT WITH SPOUT: 20 cm

DIAMETER WITH HANDLE: 17 cm

Case Pack: 6

PL60CW

Laguna® pitcher with hammered texture that hides scratches. Pour liquids from front or ice and liquid from sides. Matching tumblers available.

PE600CW

Economy and lightweight design. Pour liquids from front or ice and liquid from sides.



PE600CW

CAPACITY: 1,8 L

HEIGHT WITH SPOUT: 20 cm

DIAMETER WITH HANDLE: 18,7 cm

Case Pack: 6

P64CW

Tapered design and drip-proof spout.



P64CW

CAPACITY: 1,9 L

HEIGHT WITH SPOUT: 23,5 cm

DIAMETER WITH HANDLE: 18,5 cm

Case Pack: 6

PC64CW

Three position lid can strain ice, free pour or close to protect contents.



PC64CW

CAPACITY: 1,9 L

HEIGHT WITH SPOUT: 24,8 cm with lid

DIAMETER WITH HANDLE: 18,5 cm

Case Pack: 6

PC34CW

Stackable pitchers and lid with frosted design to hide scratches.



PC34CW

CAPACITY: 1 L

HEIGHT WITH SPOUT: 19 cm with lid

DIAMETER WITH HANDLE: 17 cm

Case Pack: 6

P34CW

Stackable pitcher only.

P34LCW

Stackable pitcher lid only.



P34CW / P34LCW

CAPACITY: 1 L / —

HEIGHT WITH SPOUT: 16,8 cm / 5,1 cm

DIAMETER WITH HANDLE: 17 cm / 11,4 cm

Case Pack: 6

LIDO® - SAN TUMBLERS AND CAMWEAR® TUMBLERS

Lido® – San Tumblers

- Easy to clean internal stacking ring promotes stable and space-efficient storage.
- Made of impact resistant SAN plastic that resists chips and breaks, minimizing replacement costs.

Color: Clear (152).
Disposable CamLid Color:
 Translucent (190).

Capacity is to the top fill-line.

Lido Tumblers are covered by U.S. Patent D720,963 S.

*177 and 266 mL tumblers feature subtle graduation markings intended for use in healthcare operations.



CODE	LDT5	LDT6	LDT9	LDT10	LDT12	LDT16	LDT22
FITS LID	CLJ6	CLST6	CL900P	CLNT10	CLNT12	CLST9	CLSM8B5**
DIAMETER	5,9 cm	6,8 cm	8,1 cm	7,3 cm	7,6 cm	8,4 cm	8,9 cm
HEIGHT	9,4 cm	9,4 cm	9,4 cm	11,4 cm	12,5 cm	13,5 cm	16,8 cm
FULL SIZE CAMRACK®	49S318	36S318	25S318	36S418	30S434	25S534	20S638
CAPACITY TO RIM	150 mL	177 mL*	266 mL*	300 mL	355 mL	480 mL	650 mL
CASE PACK TUMBLER / LID	36 / 1,000	36 / 1,000	36 / 1,000	36 / 1,000	36 / 1,000	36 / 1,000	36 / 1,500

**Excludes a cross-slot for straws.

Camwear Tumblers

- The look and feel of glass but made of durable Camwear.
- Textured exterior surface resists scratching.
- Smooth interior promotes easy cleaning.
- Designed with a Sani-Rim lip for sanitary drinking.

Color: Clear (152).

Capacities calculated to rim.

Personalization available. See crestring section for information and ordering.

Withstands temperatures from -40° to 99°C.



STOCK PRODUCTS & COLORS AVAILABLE IN OUR EUROPEAN WAREHOUSE

500CW, 800CW: (152)



CODE	500CW	800CW	850CW	950CW	1200CW	1600CW
FITS LID	—	—	—	CLNT10	—	CL900P
MAX DIAMETER	5,7 cm	6,7 cm	8,6 cm	7 cm	7,5 cm	7,9 cm
MAX HEIGHT	9,2 cm	10,2 cm	9,7 cm	11,1 cm	13,2 cm	14,6 cm
FULL SIZE CAMRACK®	49S318	36S418	25S418	36S418	36S434	25S534
CAPACITY TO RIM	160 mL	237 mL	269 mL (heavy wall)	284 mL	384 mL	503 mL
CASE PACK TUMBLER / LID	48 / —	48 / —	48 / —	48 / 1,000	48 / —	48 / 1,000

CAMWEAR® HUNTINGTON® & NEWPORT – SAN TUMBLERS

Huntington Tumblers

- Feature the elegant look and feel of glass without the high replacement costs.
- Made of durable Camwear.
- Lightweight.
- Stacking lugs to prevent sticking.
- Three sided drain bottom for easy washing and drying.

Colors: Azure Blue (196), Clear (135).
Lid Color: Translucent (190).

Capacities calculated to rim.

Personalization available. See crestring section for information and ordering.

Withstands temperatures from -40° to 99°C.

*Excludes a cross-slot for straws.



STOCK PRODUCTS & COLORS AVAILABLE IN OUR EUROPEAN WAREHOUSE

HT5CW, HT8CW, HT120CW, HT10CW, HT12CW: (135)



CODE	HT5CW	HT8CW	HT10CW	HT120CW	HT12CW	HT14CW	HT16CW	HT22CW
FITS LID	—	CLNT8	—	CLNT12	—	—	CLAM8B5*	CLSM8B5*
MAX DIAMETER	6 cm	6,8 cm	7,1 cm	7,6 cm	8,6 cm	8,3 cm	8,4 cm	8,9 cm
MAX HEIGHT	9 cm	11,3 cm	12,2 cm	12,8 cm	9,5 cm	12,4 cm	14 cm	17 cm
FULL SIZE CAMRACK®	49S318	36S418	36S434	25S434	25S418	25S434	25S534	25S638
CAPACITY TO RIM	148 mL	237 mL	296 mL	355 mL	355 mL	414 mL	473 mL	652 mL
CASE PACK TUMBLER / LID	36 / —	36 / 1,000	36 / —	36 / 1,000	36 / —	36 / —	36 / 2,000	36 / 1,500

Newport Tumblers

- Fluted design features the upscale look of glass with the safety benefits and cost savings of plastic.
- Impact resistant SAN plastic resists chips and breaks.
- Stacking lugs prevent sticking.
- Sani-Rim lip provides a sanitary drinking surface.

Colors: Clear (152), Amber (153), Slate Blue (401).

Lid Color: Translucent (190).

Capacities calculated to rim.

Personalization available. See crestring section for information and ordering.

Withstands temperatures from -20° to 85°C.

*Excludes a cross-slot for straws.



STOCK PRODUCTS & COLORS AVAILABLE IN OUR EUROPEAN WAREHOUSE

NT5, NT8, NT9, NT10, NT12: (152)



CODE	NT5	NT8	NT9	NT10	NT12	NT14	NT16	NT20
FITS LID	CLNT5	CLNT8	CLNT9	CLNT10	CLNT12	—	—	CLSM8B5*
MAX DIAMETER	6,4 cm	6,8 cm	8,3 cm	7,1 cm	7,6 cm	7,9 cm	8,3 cm	8,7 cm
MAX HEIGHT	9,4 cm	10,2 cm	8,4 cm	11,6 cm	13 cm	12,7 cm	14,6 cm	16,5 cm
FULL SIZE CAMRACK	36S318	36S418	25S318	36S434	25S434	25S434	25S534	25S638
CAPACITY TO RIM	189 mL	228 mL	275 mL	300 mL	373 mL	414 mL	485 mL	650 mL
CASE PACK TUMBLER / LID	36 / 1,500	36 / 1,000	36 / 1,000	36 / 1,000	36 / 1,000	36 / —	36 / —	36 / 2,000

LAGUNA® – SAN & DEL MAR® TUMBLERS

Laguna Tumblers

- Hammered texture hides water spots and scratches.
- Made of impact resistant SAN.
- Lightweight and easy to carry.

Colors: Clear (152), Spanish Green (427).
Lid Color: Translucent (190).

Capacities calculated to rim.

Personalization available. See crestring section for information, ordering and pricing.

Withstands temperatures from -20° to 85°C.

*Excludes a cross-slot for straws.



STOCK PRODUCTS & COLORS AVAILABLE IN OUR EUROPEAN WAREHOUSE

LT8, LT10, LT12, LT22: (152)



CODE	LT6	LT8	LT10	LT12	LT14	LT16	LT22
FITS LID	CLL6	CLL8	CLL10	CLL12	—	CLAM8B5*	—
MAX DIAMETER	6,3 cm	6,9 cm	7,4 cm	7,9 cm	8,3 cm	8,4 cm	9,3 cm
MAX HEIGHT	10,7 cm	10,9 cm	12,1 cm	12,7 cm	13,1 cm	14 cm	15,4 cm
FULL SIZE CAMRACK®	36S418	36S418	30S434	25S434	25S434	25S534	16S534
CAPACITY TO RIM	177,4 mL	236,6 mL	295,7 mL	354,9 mL	414 mL	473,2 mL	650,6 mL
CASE PACK TUMBLER / LID	36 / 1,500	36 / 2,000	36 / 1,000	36 / 1,000	36 / —	36 / 2,000	36 / —

Del Mar Tumblers

- Cracked glass look features the lightweight handling of plastic.
- Thick sturdy base and rolled rim edge for added stability.
- Made of impact resistant SAN plastic.

Colors: Clear (152), Ruby Red (156), Sapphire Blue (608), Light Amber (609).
Lid Color: Translucent (190).

Capacities calculated to rim.

Personalization available. See crestring section for information, ordering and pricing.

Del Mar Tumblers are covered by the following U.S. Patent D 478,778 S.

Withstands temperatures from -20° to 85°C.



CODE	D8	D12	D14	D16	D24
FITS LID	—	—	CLST9	—	—
MAX DIAMETER	6,7 cm	7,5 cm	8,3 cm	7,8 cm	8,7 cm
MAX HEIGHT	10,6 cm	12 cm	8,3 cm	15,1 cm	16,8 cm
FULL SIZE CAMRACK	36S418	25S434	25S318	25S534	25S638
CAPACITY TO RIM	237 mL	355 mL	414 mL	473 mL	710 mL
CASE PACK TUMBLER / LID	36 / —	36 / —	36 / 1,000	36 / —	36 / —

COLORWARE – SAN TUMBLERS & COCA-COLA® TUMBLERS

- A classic value tumbler ideal for casual dining.
- Textured on the outside to resist scratching.
- Made of impact resistant SAN.
- Interior stacking lugs for easy storing.
- Sani-Rim lip provides a sanitary drinking surface.

Colors: Slate Blue (401), Clear (152), Amber (153), Ruby Red (156).
Lid Color: Translucent (190).

Capacities calculated to rim.

Personalization available. See crestring section for information and ordering.

Withstands temperatures from -20° to 85°C.



STOCK PRODUCTS & COLORS AVAILABLE IN OUR EUROPEAN WAREHOUSE

1200P: (152)



	500P	800P	900P	950P	1200P	1600P	2000P	—
CODE (72 PACK)	500P	800P	900P	950P	1200P	1600P	2000P	—
CODE (24 PACK)	500P2	800P2	900P2	950P2	1200P2	1600P2	2000P2	3200P2
FITS LID	CLJ6	CL800P	CL900P	CL950P	—	—	—	—
MAX DIAMETER	5,7 cm	6,7 cm	8,1 cm	7 cm	7,5 cm	8 cm	8,6 cm	10 cm
MAX HEIGHT	9,2 cm	10,2 cm	8,25 cm	11,1 cm	13,2 cm	14,6 cm	16,5 cm	18,4 cm
FULL SIZE CAMRACK®	49S318	36S418	25S318	36S418	25S434	25S534	25S638	16S738
CAPACITY TO RIM	154 mL	231 mL	287 mL	290 mL	373 mL	485 mL	650 mL	976 mL
P CODE-CASE PACK	72	72	72	72	72	72	72	—
P2 CODE-CASE PACK	24	24	24	24	24	24	24	24
LID CASE PACK	1,000	1,000	1,000	1,000	—	—	—	—

Coca-Cola® Tumblers

- Colorware Tumblers featuring the Coca-Cola trademark logo in White.
- Available only to Coca-Cola fountain customers for foodservice use.

Color: Clear (152).

Coca-Cola Logo is imprinted in white only.

These trademarked vessels may not be resold at retail and are available only for distribution to Coca-Cola Fountain customers for foodservice use.

Withstands temperatures from -20° to 85°C.



CODE	20CC	32CC
MAX DIAMETER	8,6 cm	10 cm
MAX HEIGHT	16,5 cm	18,4 cm
FULL SIZE CAMRACK	25S638	16S738
CAPACITY TO RIM	650 mL	976 mL
CASE PACK	72	24

CAMWEAR® DESSERT GLASS AND LIDO® – SAN TUMBLERS

Dessert Glass

- Large, heavy bases for stability.
- Bases designed for fast draining and complete drying.
- Chill or frost barware without concerns of thermal shock damage.

Color: Clear (135).

Personalization available. See crestring section for information, ordering and pricing.



CODE	DG3CW
MAX DIAMETER	5,8 cm
MAX HEIGHT	7,7 cm
FULL SIZE CAMRACK®	49S318
CAPACITY TO RIM	100 mL
CASE PACK	72

Available for ordering in cases only.
No broken cartons.

CAMLITER® BEVERAGE DECANTERS

Camliter Beverage Decanters

- Ideal for serving beverages at restaurants, buffets, and outdoor events.
- Spill-proof, snap tight flat lids included to protect content from cross contamination.
- Flip lid design to seal beverages and make it easy to pour.
- Pour spout lid available to protect content while allowing free pour.
- Light weight; dent, impact, and scratch resistant material.
- NSF Listed (bottles only; lids not listed).

Color: Clear (135).
Lid Color: White (148).
Flip Lid Color: White (190).

Personalize with a logo to promote your brand. For information please refer to the Table Service Personalization page.



Lids not NSF listed.



WW750T

WW1000T

WW250

WW1000

WW1500

WW500

WW750

STOCK PRODUCTS & COLORS AVAILABLE IN OUR EUROPEAN WAREHOUSE

WW1000, WW500, WW250: (135)
 WW1000L, WW1000LS: (148)



WW1000LT - Flip Lid®



WW1000L - Flat Lid



WW1000LS - Pour Spout

CODE	CAPACITY	HEIGHT
Camliters with Flat Lids		
WW1500	1,5 L	25,4 cm
WW1000	1	24,8
WW750 New!	0,75	22,17
WW500	0,5	20
WW250	0,25	15,9
Camliters with Flip Lids		
WW1000T New!	1	24,61
WW750T New!	0,75	22,17

Lids

WW1000LS (Pour spout lid for 1,5 L, 1L, 0,75 L and 0,5 L)

WW1000L (Replacement lid for 1,5 L, 1L, 0,75 L and 0,5 L)

WW1000LT (Flip lid for WW750T and WW1000T)

WW250L (Replacement lid for 0,25 L)

Case Pack: 12 **In Stock Color:** Clear (135) or White (190) for Flip Lid.

BEVERAGE DISPENSER, PAIL WITH BAIL & SWIRL BOWLS®

21 L Beverage Dispenser

- Perfect for mixing and serving concentrated beverages.
- Standard and metric graduations are printed on dispenser.
- Impact resistant polyethylene withstands temperatures from -40° to 70°C.

CODE	CAPACITY
DSPR6	21 L
Case Pack: 1	

Color: White (148).

Personalization available. See cresting section for information and ordering.



DSPR6
Capacity: 21 L

Pail with Bail – Poly

- A large, multi-purpose, 21 L pail, ideal for mixing, storing and transporting.
- Durable polyethylene withstands temperatures from -40° to 70°C, and is stain resistant.
- Snap-tight, thumb tab cover sold separately.

CODE	CASE PACK
PWB22	6
RFSC12 (cover)	6

Color: White (148).



All graduations are approximate.

Swirl Bowls

- Ideal for hot or cold side dishes, desserts, dips, or fruit.
- Fits on a plate or stacks in place on a buffet station.
- Available in durable Camwear® or break resistant SAN.

Colors:
SRB5CW and SRB13CW: Clear (135), Black (110), White (148).
SRB5 and SRB13: Clear (152), Black (110), White (148).

Made of (P.E.T.) material.



CLSRB5
Disposable
lid not NSF.



Disposable lid available



SRB13CW



SRB5CW

CODE	CAPACITY	CASE PACK
Camwear		
SRB5CW	148 mL	24
SRB13CW	384	24
SAN‡		
SRB5	148	24
SRB13	384	24
Disposable Lid		
CLSRB5	—	1,000

Disposable Lid Color: Clear (152).

CAMWEAR® WINE BUCKETS, PUNCH BOWLS & BUD VASE

Wine Buckets

- Chill and showcase wine or champagne.
- Tough Camwear won't crack or break and is easy to clean.

Color: Clear (135).

Personalization available. See cresting section for information and ordering.



CODE	DIMENSION DIA. x H
WC100CW	20,3 x 23,2 cm
WC100CWNH (w/o handles)	20,3 x 22,9

Case Pack: 1



WC100CW

Bud Vase

- Ideal for dining rooms, cafeteria tables and patient or room service trays.
- Made of durable Camwear.
- Fill with a fresh rose bud or a colorful faux flower.

Colors: Black (110), Clear (135), White (148).



CODE	DESCRIPTION	CASE PACK
BV6CW	15,24 cm bud vase	12



Black (110)

Clear (135)

White (148)

DELI CROCKS & PLATTER

- Prep, store and serve all in one with contemporary style at an economical price.
- Crock and platter are made of SAN, making them impact, stain and chip resistant.
- Ideal for supermarket delis, sandwich shops, buffets and catered events.
- Handled covers are made of crystal clear, virtually unbreakable Camwear®.

Crock and Platter Colors: Clear (152), Black (110), White (148), Red (404).

Crock Cover Color: Clear (135).

Deli Crock covers are covered by the following U.S. Patents D 504,283 S, D 503,871 S & D 494,419 S. Scalloped Food Service Cover is covered by the following U.S. Patent D 509,705 S.

DCC5, DCC10 are NSF Component.



STOCK PRODUCTS & COLORS AVAILABLE IN OUR EUROPEAN WAREHOUSE

DC5, DC10: (110), (148)

DCC5, DCC10: (135)



Prep, stack, store and serve all in one.



Interstacking saves storage space.



Avoid cross contamination and keep food fresh by using clear cover with handle.



Lid can be used as a riser to provide additional height on the buffet table or in a deli display case.



Cover doubles as a false bottom for presentation and to reduce waste.

Crocks & Platter



CODE	DC5	DC10	DP15
DESCRIPTION	Crock	Crock	Platter
DIMENSIONS L x D x H	26 x 17,5 x 8 cm	33,5 x 26,5 x 8 cm	40 x 30,5 x 5,5 cm
APPROXIMATE CAPACITY	2 L	4,6 L	3,2 L

Case Pack: 6

Covers



CODE	DCC5 fits DC5	DCC10 fits DC10
DIMENSIONS L x D x H	23,8 x 15 x 3,5 cm	31 x 24 x 3,5 cm
APPROXIMATE CAPACITY	0,85 L	1,9 L

Case Pack: 6

SHOWFEST® DISPLAY TRAYS

- Made from virtually unbreakable polycarbonate material
- Present hot and cold items side-by-side.

Color: Black (110).

Personalization not available.



SFG1012CW

Display Trays — Octagonal

DIMENSIONS L x D x H:
30,5 x 25,4 x 5 cm

APPROX. CAPACITY: 2,8 L

Case Pack: 6



SFG820CW

Display Trays — Octagonal

DIMENSIONS L x D x H:
50,8 x 20,3 x 5 cm

APPROX. CAPACITY: 3,7 L

Case Pack: 6



CAMWEAR® BOWLS

Round Pebbled Bowls

- Textured on the outside for an elegant look, smooth on the inside for easy cleaning.
- Made of virtually unbreakable Camwear for years of dependable service.
- Ideal for fruit, salads, snacks and desserts.

Color: Pebbled (176).

Capacities are calculated to rim.



Ribbed Bowls

- Stylish, contemporary appearance for a dramatic presentation.
- Made of virtually unbreakable Camwear that won't break like glass.
- Bowls are durable and lightweight. Will not chip and crack like acrylic.
- Resistant to stains, acids and odors.

Colors: Clear (135), Black (110), White (148).

Rectangular Ribbed Bowls are not available in White (148).

Capacities are calculated to rim.



Round Pebbled Bowls



CODE	PSB6	PSB8	PSB10	PSB12
INSIDE DIAMETER	15,2 cm	20,3 cm	25,4 cm	30,5 cm
APPROXIMATE CAPACITY	556 mL	1,5 L	3 L	5,5 L
CASE PACK	12	12	12	12

CAMWEAR® BOWLS

Round Pebbled Bowls



CODE	PSB15	PSB18	PSB23
INSIDE DIAMETER	38,1 cm	45,7 cm	58,4 cm
APPROXIMATE CAPACITY	10,6 L	19,1 L	37,8 L
CASE PACK	4	4	4

Color: Pebbled (176).

Rectangular Ribbed Bowls



CODE	RSB912CW	RSB1014CW	RSB1419CW
DIMENSIONS L x D x H	30,8 x 22,9 x 7,6 cm	37 x 27,3 x 9 cm	49,2 x 36,2 x 12 cm
APPROXIMATE CAPACITY	2,7 L	4,7 L	11,3 L
CASE PACK	12	4	4

Rectangular Ribbed Bowls are not available in White (148).

Round Ribbed Bowls



CODE	RSB6CW	RSB8CW	RSB10CW	RSB12CW
INSIDE DIAMETER	15,2 cm	20,3 cm	25,4 cm	30,5 cm
APPROXIMATE CAPACITY	564 mL	1,6 L	3 L	5,5 L
CASE PACK	12	12	12	12



CODE	RSB15CW	RSB18CW	RSB23CW
INSIDE DIAMETER	38,1 cm	45,7 cm	58,1 cm
APPROXIMATE CAPACITY	10,6 L	19,1 L	37,8 L
CASE PACK	4	4	4

BUDGET & FIBERGLASS BOWLS

Budget Salad Bowls

- An economical serving choice for fruit, salads, snacks and desserts.
- Impact resistant FDA approved material resists stains, acids and odors.

Colors: Birch (174), Black (110).

Personalization not available.

Capacities are calculated to rim.



CODE	SB55	SB60	SB80
INSIDE DIAMETER	14,5 cm	15,2 cm	20,3 cm
APPROX. CAPACITY	325 mL	375 mL	925 mL

Case Pack: 72

Fiberglass Bowls

- Combines the look of warm wood grains with the durability of fiberglass.
- Colors won't fade even after years of service and washing.

Color: Dark Basketweave (301).

Personalization not available.

For a swatch of this color and pattern, see Camtray® group section.

Capacities are calculated to rim.



CODE	6F	8F
INSIDE DIAMETER	15,6 cm	20,3 cm
APPROX. CAPACITY	425 mL	925 mL

Case Pack: 12

CAMWEAR® DISPLAY COVERS & TRAYS

- Display covers protect freshness of pastries, breads and desserts.
- Virtually unbreakable Camwear features the upscale look of glass.
- Openings on side or end provide quick and easy access to contents without removing cover.‡

Display Covers

Color: Clear (135).

Personalization available. See cresting section for information and ordering.

*Dimensions include handle(s).
Handle height is 2,06 cm.

Market Trays

Colors: Salmon (149), Yellow (145), Blue (142), Green (140), White (148), Black (110).

Colors NSF listed for food contact: White (148), Blue (142), Green (140).

Display Tray Colors: Clear (135), Black (110).

Personalization not available.

**Special order item not carried in stock – non-returnable.



Display Trays are stackable.
Refer to Market Tray for information.

STOCK PRODUCTS & COLORS AVAILABLE IN OUR EUROPEAN WAREHOUSE

DT1220CW: (110)
RD1200CW, DD1220ECW, DD1220BECW, DD1220SCW, RD1220CW: (135)



RD1220CW



RD1220CWH



RD1200CW



DD1220BECW‡



Dome with side cut – DD1220SCW‡



Display Tray – DT1220CW

CODE	APPROXIMATE DIMENSIONS W x L x H*	DESCRIPTION	CASE PACK
Display Covers			
RD1200CW	30,5 x 30,5 x 20,9 cm	Cake cover	1
DD1220CW	55,6 x 37,5 x 20,3	Dome cover	1
DD1220ECW	55,6 x 37,5 x 20,3	Dome w/end cut	1
DD1220BECW	55,6 x 37,5 x 20,3	Dome w/2 ends cut	1
DD1220SCW	55,6 x 37,5 x 20,3	Dome w/side cut	1
DD1826CW	67,9 x 47,9 x 22,5	Dome cover	1
RD926CW	67,2 x 25,4 x 15,9	Rectangular cover	1
RD1220CW	55,6 x 35,9 x 14,9	Rectangular cover	1
RD1220CWH	55,6 x 35,9 x 12,7	Rectangular w/hinge	1
RD1826CW	67,2 x 47,9 x 15,9	Rectangular cover	1
RD1826CWH	67,9 x 47,6 x 13	Rectangular w/hinge	1
Display Tray – Fits with all 1220 covers			
DT1220CW	32,5 x 53	Tray	1
Market Tray – Fits with all 1826 covers			
1826MT**	65,3 x 45,2 x 2,7	Tray	6

CROCKS & LADLES

Crocks

- Ideal for use with salad bars, on buffet tables or at food stations.
- Resists stains and odors caused by vinegar, salad oils, or mayonnaise.
- Made of high impact FDA accepted material.
- Smooth surface is easy-to-clean.
- Works in Salad Bar Holder SBH15 and Crock Holder CPH3.

Solid Color Crock Colors: Black (110), Beige (133), Reddish Brown (195).

Clear Crock Color: Clear (152).

Lid Color: White (148).

Personalization available. See personalization section for details.

*Lids for Solid Color and Clear Crocks are not interchangeable.



Camwear® Ladles

- Portion control bowls serve the perfect amount of dressing or food ingredient.
- Angled for easy handling.
- Designed with a side rest so ladles don't slip into crocks or serving bowls.
- Made of virtually unbreakable Camwear for years of dependable service.

Colors: Black (110), Beige (133), Clear (135), White (148).

*Cambro's assortment pack is available in black only. It offers 8 imprinted ladles and 4 with no imprinting. The 8 imprints include: 1 Thousand Island, 1 French, 1 House, 1 Italian, 1 Bleu Cheese, 1 Ranch, 1 Low Cal, 1 Caesar. This makes a perfect start-up set for a salad bar.

Custom Order Ladle Imprints – See crestring section for information and ordering. Maximum imprint area is 2,5 x 1,2 cm. Six dozen minimum.

No broken cartons on assortment pack or imprinted ladles. Special order item not carried in stock, non-returnable.



STOCK PRODUCTS & COLORS AVAILABLE IN OUR EUROPEAN WAREHOUSE

LD85, LD105: (135), (110)



CODE	HEIGHT	TOP DIAMETER	CUT OUT DIAMETER
Solid Color Crock with Lid			
CP12	13,2 cm	12,9 cm	12,1 cm
CP15	11	16,8	15,7
CP27	17,2	16,8	15,6
Clear Color Crock with Lid			
CCP12	13,7	13,3	12,4
CCP15	11,1	17,2	15,9
CCP27	17,5	17,2	15,7

CODE	CAPACITY	CASE PACK
Solid Color Crocks		
CP12	1,1 L w/Lid	12
CP15	1,4 L w/Lid	6
CP27	2,4 L w/Lid	6

Lids for Solid Color Crocks		
CPL12*	Fits Colored CP12 Crock	12
CPL27*	Fits Colored CP15 & CP27	12

Clear Crocks		
CCP12	1,1 L w/Lid	12
CCP15	1,4 L w/Lid	6
CCP27	2,4 L w/Lid	6

Lids for Clear Crocks		
CCPL12*	Fits Clear CCP12 Crock	12
CCPL27*	Fits Clear CCP15 & CCP27	12



Imprinted Ladles shown.

CODE	DESCRIPTION	LENGTH	CAPACITY
LD85	Plain	21,6 cm	25 mL
LD85A*	Assortment	21,6	25
LD105	Plain	26,8	30
LD105A*	Assortment	26,8	30
LD130	Plain	33	30

Case Pack: 12

CAMWEAR® SERVING SPOONS, TONGS & HIGH HEAT CAMTENSILS®

Serving Spoons

- Made of virtually unbreakable Camwear, spoons won't tarnish, bend or dent.
- A wide handle and molded in thumb rest ensure a solid, ergonomic grip.
- Spoons feature a notched back to rest on pans.
- Spoon capacities are approximate and are not intended for measuring.

Colors: Black (110), Beige (133), Clear (135), Red (404), White (148).

Personalization available. See crestring section for information, ordering and pricing.

*Cannot be personalized.



Perforated



SPOP10CW
DESCRIPTION: 25,5 cm Perforated buffet spoon
DIMENSIONS: 26 x 4,3 cm
Case Pack: 12



SPOP11CW*
DESCRIPTION: 28 cm Perforated deli spoon
DIMENSIONS: 28,3 x 7,3 cm
Case Pack: 12



SPOP13CW*
DESCRIPTION: 33 cm Perforated deli spoon
DIMENSIONS: 33,3 x 7,3 cm
Case Pack: 12

Solid



SPO8CW
DESCRIPTION: 20,5 cm Salad spoon
DIMENSIONS: 20,6 x 3,8 cm
Case Pack: 12



SPO10CW
DESCRIPTION: 25,5 cm Buffet spoon
DIMENSIONS: 26 x 4,3 cm
Case Pack: 12



SPO11CW*
DESCRIPTION: 28 cm Deli spoon
DIMENSIONS: 28,3 x 7,3 cm
Case Pack: 12



SPO13CW*
DESCRIPTION: 33 cm Deli spoon
DIMENSIONS: 33,3 x 7,3 cm
Case Pack: 12

High Heat Camtensils, Spoons and Turners

- Ideal for preparing and serving hot and cold foods.
- Made of a durable high heat material that withstands temperatures from -40° to 190°C.
- Handle includes a hole for hanging when not in use and notches to rest on pans.

Colors: Amber (150), Black (110).

Personalization not available.



SPO13
DESCRIPTION: 33 cm Solid spoon
DIMENSIONS: 33,3 x 7,3 cm
Case Pack: 12



SPA14
DESCRIPTION: 35,5 cm Solid turner
DIMENSIONS: 35,9 x 8,9 cm
Case Pack: 12



SPOP13 PERFORATED
DESCRIPTION: 33 cm Perforated spoon
DIMENSIONS: 33,3 x 7,3 cm
Case Pack: 12



SPASL14 SLOTTED
DESCRIPTION: 35,5 cm Slotted turner
DIMENSIONS: 35,9 x 8,9 cm
Case Pack: 12



STOCK PRODUCTS & COLORS AVAILABLE IN OUR EUROPEAN WAREHOUSE

SPO11CW, SPO13CW, SPOP13CW: (110), (135)
 SPO8CW, SPO10CW, SPOP11CW: (110)

STOCK PRODUCTS & COLORS AVAILABLE IN OUR EUROPEAN WAREHOUSE

SPO13, SPOP13, SPA14: (150)

LUGANO® TONGS

- Colored tongs are made from a durable heat resistant material that withstands temperatures up to 99°C.
- Clear tongs are made from virtually unbreakable Camwear, which is safe to 99°C.

FLAT GRIP



TG6
LENGTH: 15 cm
Case Pack: 12



TG9
LENGTH: 23 cm
Case Pack: 12

SCALLOP GRIP



6TGS
LENGTH: 15 cm
Case Pack: 12



9TGS
LENGTH: 23 cm
Case Pack: 12

Colors: Black (110), Beige (133), Clear (135), Red (404), White (148).



STOCK PRODUCTS & COLORS AVAILABLE IN OUR EUROPEAN WAREHOUSE

6TGS, 12TGS, T69: (135), (110)
9TGS: (135), (110), (148)
T66: (110)



12TGS
LENGTH: 30,5 cm
Case Pack: 12



Lugano Angled and Easy-Grasp Tongs

- Angled tongs feature an ergonomic design that makes it easy to serve a variety of foods.
- Easy-Grasp Tongs provide a secure grip for hard to hold items.

ANGLED TONG



TGA8
LENGTH: 21 cm
Case Pack: 12



TGA11
LENGTH: 27,5 cm
Case Pack: 12

Angled Tong Color: Black (110).
Easy-Grasp Colors: Black (110), Beige (133), Clear (135), White (148).

Angled and Easy-Grasp Lugano Tongs are covered under U.S. Patent D 530,994 S.



EASY-GRASP



TGG6
LENGTH: 17 cm
Case Pack: 12



TGG9
LENGTH: 24 cm
Case Pack: 12



CAMVIEW® SHAKERS/DREDGES & CAMWEAR® CONDIMENT JARS

CamView Shakers/Dredges

- A staple in the kitchen, at the condiment station or on the dining table.
- Clear shatter-resistant CamView and color coded lids make it easy to identify contents.
- Dishwasher safe and unaffected by food acids.

Shaker Color: Clear (135).

Personalization available. See cresting section for information, ordering and pricing.



96SKRLD
Salt & Pepper



96SKRLM
Med. Ground



96SKRLC
Cheese



96SKRLP
Parsley

CODE

Shakers complete with lids (approx. capacity 300 mL)

CODE	LID COLOR
96SKRP (w/parsley lid)	White (148)
96SKRD (w/salt & pepper lid)	Beige (406)
96SKRC (w/cheese lid)	Yellow (405)
96SKRM (w/medium ground lid)	Rose (408)

Shaker Replacement Lids (Shaker Lids are not interchangeable with Camliter® Lids)

96SKRLP parsley lid	White (148)
96SKRLD salt & pepper lid	Beige (406)
96SKRLC cheese lid	Yellow (405)
96SKRLM medium ground lid	Rose (408)

Case Pack: 12

Camwear Condiment Jar

- Use to hold condiments such as mustard, ketchup, dressings, jam or salsa.
- Made of clear, virtually unbreakable Camwear.
- Lids are slotted to hold serving spoons when not in use.

Color: Clear (135).

Personalization available. See cresting section for information, ordering and pricing.



CODE	APPROXIMATE CAPACITY	SIZE H x DIA.	CASE PACK
Condiment Jar Set			
CJ80CW	240 mL	10,2 x 8,3 cm	24

CHOOSE THE RIGHT TRAY FOR YOUR BUSINESS

Cambro is the global leader in manufacturing trays for the food service industry, offering the largest selection of materials, sizes, colors, shapes and personalization processes. Cambro's breadth of assortment provides the clear choice for the right tray for every need and budget.

Consider the following to select the right tray for your operation:

Step 1: What Will the Tray Be Used For?

In order to choose the correct tray, first identify the correct application.

Service Tray

Used by employees to carry items to serve to guests:

Non-Slip Tray

Patron Tray

Used by customers to carry menu items:

Smooth Surface Tray

Step 2: Who Will Be Using the Tray?

To determine the appropriate tray material, it is critical to identify who will be using the tray.

Children

Students

Military

Office Employees

Wait Staff

Step 3: How Will the Tray Be Used and Washed?

Consider how the tray will be used, and whether it will endure mild or excessive use and abuse. Determine how often the trays will be washed per day.

Extensive:

Wash as often and as frequently as needed

Normal:

Wash up to 3 times per day

Minimal:

Wash once per day

Step 4: Determine the Budget per Tray

Ensure that the correct tray has been selected for the right application. Selecting a low cost tray for a heavy application is not the most cost effective option. Tray pricing varies according to the following factors:

Manufacturing process

Material type and grade

Tray size

Personalization options

Warranty

Step 5: Personalization

Cambro offers high quality personalization on most of the trays that we manufacture. Look for the personalization logo throughout the brochure. 

Step 6: Additional Features to Consider

Evaluate the importance of the following features to determine the best tray for your operation.

Stacking lugs - Promote air circulation for fast drying and perfect stacking

Surface impact resistance

Edge breaking resistance

Scratch and stain resistance

Type of Warranty

Technical test descriptions

All Cambro trays are submitted to an array of tests described to the right. The results are indicated on each tray page under Technical Test Results.



Textured Wood Trays



Versa Trays Anitmicrobial



Versa Lite Trays



Laminated Capri Trays



Laminated Corfu Trays



Laminated Mykonos Trays



Fast Food Trays



Non-Slip Trays

TESTS DESCRIPTIONS

Thermal Shock Resistance Test:

Test consists of applying a radical temperature change during a short period of time to the tray, by taking out the tray from icy water (0°C) and placing it into boiling water (100°C) and measuring any deformation.

Break Resistance Test:

Test consists of dropping a metal ball from specific heights onto the tray and measuring any deformation.

Scratch Resistance Test:

Observe scratches and abrasions as a result of friction between porcelain dinnerware and the tray surface.

Test consists of moving a porcelain dish placed on tray from left to right under hand pressure and measuring any abrasion on tray surface.

DISHWASHER SAFE DESCRIPTIONS

Extensive: Wash as often and as frequently as needed.

Normal: Wash up to 3 times per day.

Minimal: Wash once per day.

PERSONALIZATION

Value Added Personalization

Promote business to customers and employees alike by placing your custom logo, trademark, slogan or design on our trays.

How to Order

- 1) Select a tray size, color, pattern, or design.
- 2) Provide complete, camera-ready artwork and indicate positioning on the tray.
- 3) According to the tray type, Cambro can produce 1, 2, 3 and 4 color artwork as well as 4 color process artwork.

We require the following:

- a. Electronic artwork file provided on CD-ROM for Mac or PC.

We accept the following file formats:

- Adobe Illustrator, Adobe Photoshop files in JPEG, TIFF or EPS formats.
 - File dimensions must equal 100% of reproduction size at 300dpi resolution.
- b. Illustration on paper: The quality of the art must be crisp and scannable. Please specify PANTONE number for each color or indicate if it is a four color process.
 - 4) An artist's fee of *** per hour will be charged to any order submitted

without complete, camera-ready artwork. Cambro will contact you if this fee will be charged and will give you an estimated cost.

5) Sample process:

- a. For any new project, a finished sample will be submitted for the customer's approval.
- b. The first sample with a firm purchase order is free. (Plus shipping cost.)
- c. Samples not accompanied by a firm purchase order or requests for more than one sample will be charged a flat rate of:

- Polyester, Fiberglass and Laminated Trays:
*** Net per sample.
(Plus shipping cost.)
- Polypropylene Fast Food Trays:
*** Net per sample.
(Plus shipping cost.)
- d. Upon receipt and shipment of a firm purchase order, a credit will be applied to your account for the cost of one sample.
- 6) Personalization charges apply to both original orders and returns.

POLYESTER TRAYS

Versa Trays VT/GP Versa Lite Trays VL/GL

- Only the following tray models are suitable for personalization:

Versa Trays:

VT1216, VT1418, VT2632, VT3253, VT3343, VT3343C, VT3646C, VT3753, VT3853, GP0540, GP1070, GP1080, GP3074, GP3980, GP4002, GP4210, GP4004, GP4701, GP4709, GP4853

Versa Lite Trays:

VL1014, VL1216, VL1418, VL2632, VL3253, VL3343, VL3343C, VL3646C, VL3753, GL0540, GL1070, GL1080, GL3074, GL3980, GL4002, GL4210, GL4701, GL4709

- **Minimum Quantity:** 120 trays per size.
- **Sample Production Time:** 10 business days + delivery and transit time from receipt of camera ready artwork.
- **Order Production Time:** Up to 4-6 weeks + delivery and transit time from the date artwork is approved and the order is confirmed.
- Request for additional samples without a firm purchase order will be charged *** Net per sample. (Plus shipping cost.)

Printing Process Applicable:

Digital Printing - Inside Trays Process: allows printing of one color or multiple color artwork as well as photo reproduction.

Tray Colors Recommended for Personalized Versa Trays VT/GP:

Speckled Mocha (A21), Sahara (A22), Light Grey (A27), Pearl White (A33), Terrazzo (A86).

For the following colors, please call Cambro Customer Service for artwork review: Magic Yellow (A25), Magic Mint (A26).

Tray Colors Recommended for Personalized Versa Lite Trays VL/GL:

Speckled Smoke (A20), Speckled Mocha (A21), Sahara (A22), Light Grey (A27), Pearl White (A33) and Terrazzo (A86).

Printable Area:

The artwork can cover the flat surface of tray up to 1 cm from the internal tray edge.

Personalization Charges Per Tray:

QUANTITY EACH	ADDITIONAL NET CHARGES
120-300	***
312-996	***
1,008 and up	***

***Contact your Cambro representative for pricing.

If you are using Thermo-Chemical Disinfection Equipment, please contact us. We will assist you finding the right tray for your application.



FIBERGLASS TRAYS

Camtray® Trays

- All Camtray sizes can be personalized. (Except compartment trays shown in main Cambro catalog).
- **Minimum Quantity:** 144 trays per size.
- **Sample Production Time:** 10 business days + delivery and transit time from receipt of camera ready artwork.
- **Order Production Time:** Up to 4-6 weeks + delivery and transit time from the date artwork is approved and the order is confirmed.
- Request for additional samples without a firm purchase order will be charged *** Net per sample. (Plus shipping cost.)

Printing Process Applicable:

a. Digital Printing - Edge to Edge: allows printing of one color or multiple color artwork as well as photo reproduction.

Printable area: Print area covers 100% of surface, edge to edge on top and bottom of the tray. Available for Decor Series Camtrays and select Camtrays.

b. Digital Printing - Inside Trays: allows printing of one color or multiple color artwork as well as photo reproduction. This process can only be used on light color trays. Darker tray color will make the artwork colors go darker.

Tray Colors Recommended for Four Color Printing Process:

Antique Parchment (101), Light Peach (106), Dark Peach (117), White (148), Sky Blue (177), Key Lime (429), Lemon Chiffon (536), Cameo Yellow (537), Cottage White (538).

Printable area: The artwork can cover the flat surface of tray up to 3,5 cm from the internal tray edge.

c. Silkscreen Printing Personalization: allows up to four colors. This process is best used with light color artwork on dark tray color.

Printable area: covers 100% of surface, edge to edge on top and bottom of the tray.

Personalization Charges Per Tray:

QUANTITY EACH	ADDITIONAL NET CHARGES
144-299	***
300 and up	Free

***Contact your Cambro representative for pricing.



PERSONALIZATION

LAMINATED TRAYS

Corfu, Capri, Mykonos, Madeira

- All Laminated tray sizes can be personalized or produced in any custom color. Custom color matching is treated as a personalization.
- Top and bottom parts of trays can be personalized with the exception of Corfu trays that can only be personalized on the backside of the tray. Personalization cost is per side of the tray.
- Minimum Quantity:** 120 trays per size.



- Sample Production Time:** 10 business days + delivery and transit time from receipt of camera ready artwork.
- Order Production Time:** Up to 4-6 weeks + delivery and transit time from the date artwork is approved and the order is confirmed.

- Request for additional samples without a firm purchase order will be charged *** Net per sample. (Plus shipping cost.)

Printing Process Applicable: Four color process and Custom Color Matching.

- a. Digital Printing - Inside Trays Process:** This process allows the printing of one color or multiple color artwork as well as photo reproduction.
- b. Custom Color Matching:** Custom color matching is treated as a personalization. To produce any color tray provide Cambro with PANTONE number.

Printable area: The artwork can cover the total surface of tray from one edge to the other. Artwork dimensions must be 4 cm bigger than tray sizes on each side due to trimming. (example: Tray size: 36 x 46 cm – Artwork size: 40 x 50 cm)

Personalization Charges Per Tray:

QUANTITY EACH	ADDITIONAL NET CHARGES
120 and up	***

***Contact your Cambro representative for pricing.

POLYPROPYLENE TRAYS

Fast Food Trays

- All Fast Food trays sizes manufactured in the United States can be personalized. All Fast Food tray sizes manufactured in Europe and China cannot be personalized.
- Minimum Quantity:** 288 trays per size.
- Sample Production Time:** 10 business days + delivery and transit time from receipt of camera ready artwork.



- Order Production Time:** Up to 4-6 weeks + delivery and transit time from the date artwork is approved and the order is confirmed.

- Request for additional samples without a firm purchase order will be charged *** Net per sample. (Plus shipping cost.)

Printing Process Applicable:

Hot stamp 1 color process. Due to the application process onto textured tray surface, white can be selected but is not recommended.

Printable area: Artwork cannot exceed a maximum size of 15 x 15 cm.

Personalization Cost:

One-time die charge: *** Net per order

Additional Net Charges Per Tray:

QUANTITY EACH	ADDITIONAL NET CHARGES
288-767	***
768-1,199	***
1,200-5,999	***
6,000-11,999	***
12,000 and up	***

***Contact your Cambro representative for pricing.

CAMTREAD TRAYS

Tray Back Personalization and Rubber Surface Embossing

- Camtread From USA:** Tray Back Personalization only on 1600CT. Rubber surface embossing all Camtread sizes.
- Camtread From Europe:** Sizes Available: 1100CT, 1400CT, 1600CT and 1800CT.
- Sample Production Time:** 10 business days + delivery and transit time from receipt of camera ready artwork.
- Order Production Time:** Up to 4-6 weeks + delivery and transit time from the date artwork is approved and the order is confirmed.

- Request for additional samples without a firm purchase order will be charged *** Net per sample. (Plus shipping cost.)

Tray Back Personalization Printing Process Applicable: **Four Color Printing Process** allows printing of one color or multiple color artwork as well as photo reproduction. Camtread From USA: White trays are recommended for tray back personalization.

Printable area: The artwork can cover the flat surface of tray up to 2,54 cm from the external tray edge.

Personalization Charges Per Tray:

QUANTITY EACH	ADDITIONAL NET CHARGES
Camtread From USA	
72-144	***
145-288	***
289-432	***
433 and up	Free
Camtread From Europe	
120 and up	***

Rubber Surface Embossing

- Electronic File Format:** Adobe Illustrator EPS formats.

Embossing Process Printable Area: The artwork can cover the surface of the tray up to 2,54 cm from the internal tray of edge.

Embossing Personalization Charge Per Tray:

QUANTITY EACH	ADDITIONAL NET CHARGES
Camtread From USA	
72 and up	***
Camtread From Europe	
156 and up	***

***Contact your Cambro representative for pricing.

TRAY PRODUCT GUIDE

POLYESTER TRAYS

						
RECOMMENDED USE						
TRAY DESCRIPTION	Century™ Textured Wood Trays Page 216	Century™ Fun Trays: Versa Trays VT/GP Versa Lite Trays VL/GL Page 217	Versa Trays Ecologic Series Page 215	Versa Tray Plus Page 215	Versa Trays VT/GP Pages 218-219	Versa Lite Trays VL/GL Pages 220-221
MATERIAL	SMC-High Performance Fiberglass	SMC-High or Standard Performance Fiberglass Reinforced Polyester	Natural Material + SMC-High Performance Fiberglass Reinforced Polyester	SMC-High Performance Fiberglass Reinforced Polyester	SMC-High Performance Fiberglass Reinforced Polyester	SMC-Standard Performance Fiberglass Reinforced Polyester
SURFACE	Textured / Textured Non-Slip	Smooth	Smooth	Smooth	Smooth	Smooth
PERFORMANCE	Excellent	Excellent	Excellent	Excellent	Excellent	Excellent
PERSONALIZATION	No	Yes Δ Heat resistance: 90°C	Yes Δ Heat resistance: 90°C	No	Yes Δ Heat resistance: 90°C	Yes Δ Heat resistance: 90°C
YEARS WARRANTIED**	5	3	5	5	5	3
STACKING LUGS*	Yes	Yes	Yes	Yes	Yes	Yes
DISHWASHER SAFE	Yes – Extensive	Yes – Normal	Yes – Extensive	Yes – Extensive	Yes – Extensive	Yes – Normal
CHEMICAL RESISTANCE	Excellent	Good	Excellent	Excellent	Excellent	Good
DRYING TEST	Excellent	Excellent	Excellent	Excellent	Excellent	Excellent
THERMAL SHOCK RESISTANCE	Excellent	Good	Excellent	Excellent	Excellent	Good
BREAK RESISTANCE	Excellent	Good	Excellent	Excellent	Excellent	Good
SCRATCH RESISTANCE	Excellent	Good	Excellent	Excellent	Excellent	Good
STAIN RESISTANCE	Excellent	Good	Excellent	Excellent	Excellent	Good
HEAT RESISTANCE	-40° to +90°C ‡	-40° to +90°C ‡	-40° to +140°C ‡	-40° to +140°C ‡	-40° to +140°C ‡	-40° to +130°C ‡
NUMBER OF SIZES	4	2	5	5	22	15
NUMBER OF SHAPES	1	1	4	4	9	7
NUMBER OF COLORS	7	4	2	1	12	7

*Stacking lugs allow free air circulation and perfect stacking.

**Prorated warranty against manufacturer's defects.

‡Not recommended for heated cart.

Δ Contact your Cambro representative for pricing.

If you are using Thermo-Chemical Disinfection Equipment, please contact us. We will assist you finding the right tray for your application.

POLYESTER TRAYS

- Versa Tray Ecologic Series
- Versa Tray Plus
- Versa Trays
- Century™ Textured Wood Trays
- Versa Century Fun

High performance polyester trays are made of rugged reinforced mat with long fibers and additional fiberglass to provide extremely high shock-resistance. Colored isophthalic polyester resin offers high chemical and UV-resistance.

- (1) Personalized Versa Trays and Versa Trays with Décor have a Melamine Resin Layer on top increasing protection against stains, abrasions and scratches.

VERSA LITE TRAYS

- VL/GL Century Fun
 - VL/GL Trays
 - VL/GL Trays with Non-Slip Surface
- Standard performance polyester trays are made of fiberglass and standard polyester resin.



Canteens / Cafeterias / Self-serve



Catering / Banquet Service



Educational



Hospitals



Hotel / Room service



Military



Restaurants / Cafes / Brasseries / Pubs / Bars / Clubs

TRAY PRODUCT GUIDE

POLYESTER TRAYS

FIBERGLASS TRAYS



RECOMMENDED USE



TRAY DESCRIPTION

Versa Lite Trays with Non-Slip Rubber Surface VL/GL
Page 222

Decór Series Camtrays
Pages 223

Camtray®
Pages 224-227

EpicTread™ Trays
Page 228

Dietary Trays
Page 229

Camlite® Trays
Page 229

MATERIAL

SMC-Standard Performance Fiberglass Reinforced Polyester + Non-Slip Rubber Surface

Fiberglass Layers + Polyester Resin

Fiberglass Layers + Polyester Resin

Fiberglass Layers + Non-Slip, Water Repellent Surface

Fiberglass Layers + Polyester Resin

Fiberglass Layers + Polyester Resin

SURFACE

Non-Slip Rubber

Smooth

Smooth

Non-Slip

Smooth

Smooth

PERFORMANCE

Excellent

Excellent

Excellent

Good

Excellent

Excellent

PERSONALIZATION

No

Yes Δ
Heat resistance:
100°C

Yes Δ
Heat resistance:
100°C

No

No

No

YEARS WARRANTIED**

3

5

5

2

1

3

STACKING LUGS*

Yes

Yes

Yes

Yes

Yes

Yes

DISHWASHER SAFE

Yes – Normal

Yes – Extensive

Yes – Extensive

Yes – Normal

Yes – Extensive

Yes – Extensive

CHEMICAL RESISTANCE

Good

Good

Good

Good

Good

Good

DRYING TEST

Excellent

Excellent

Excellent

Good

Excellent

Excellent

THERMAL SHOCK RESISTANCE

Good

Excellent

Excellent

Good

Excellent

Excellent

BREAK RESISTANCE

Good

Excellent

Excellent

Good

Good

Good

SCRATCH RESISTANCE

Good

Excellent

Excellent

Good

Good

Good

STAIN RESISTANCE

Good

Excellent

Excellent

Good

Excellent

Excellent

HEAT RESISTANCE

-40° to +100°C ‡

-10° to +100°C ‡

-10° to +100°C ‡

-10° to +90°C ‡

-10° to +100°C ‡

-10° to +100°C ‡

NUMBER OF SIZES

7

3

40

6

6

6

NUMBER OF SHAPES

3

1

7

2

1

2

NUMBER OF COLORS

2

4

52

6

52

9

*Stacking lugs promote air circulation and perfect stacking.

**Prorated warranty against manufacturer's defects.

Δ Contact your Cambro representative for pricing.

‡Not recommended for heated cart.

VERSA LITE TRAYS

- VL/GL Century Fun
- VL/GL Trays
- VL/GL Trays with Non-Slip Surface
- VL/GL Trays with Non-Slip Rubber Surface

Standard performance polyester trays are made of fiberglass and standard polyester resin.

FIBERGLASS TRAYS

- Camtray
- Decór Series Camtrays
- EpicTread Trays
- Dietary Trays
- Camlite Trays

Made of rugged fiberglass interior to provide a tough inner foundation and smooth surface, coupled with polyester resin to resist impact and stains.



Canteens / Cafeterias / Self-serve



Educational



Food courts / Snack shops / Quick serve



Hospitals



Catering / Banquet Service



Hotel / Room service



Military



Restaurants / Cafes / Brasseries / Pubs / Bars / Clubs

TRAY PRODUCT GUIDE

	CAMWEAR® TRAYS	FIBERGLASS TRAYS	POLYPROPYLENE
RECOMMENDED USE			
TRAY DESCRIPTION	Camwear Trays Page 230	Camwear Trays with Non-Slip Surface Page 230	Camtread® Trays Page 232
MATERIAL	Camwear	Camwear + Non-Slip Surface	Treadlite™ Trays Page 233
SURFACE	Textured	Non-Slip	Polytread® Trays Page 233
PERFORMANCE	Excellent	Excellent	Excellent
PERSONALIZATION	No	No	Yes Δ
YEARS WARRANTIED**	3	3	5
STACKING LUGS*	Yes	Yes	Yes
DISHWASHER SAFE	Yes – Extensive	Yes – Extensive	Yes – Extensive
CHEMICAL RESISTANCE	Good	Good	Good
DRYING TEST	Excellent	Excellent	Excellent
THERMAL SHOCK RESISTANCE	Excellent	Excellent	Excellent
BREAK RESISTANCE	Excellent	Excellent	Good
SCRATCH RESISTANCE	Very Good	Good	Excellent
STAIN RESISTANCE	Very Good	Good	Good
HEAT RESISTANCE	-40° to +99°C ‡	-40° to +82°C ‡	-10° to +80°C ‡
NUMBER OF SIZES	2	2	16
NUMBER OF SHAPES	3	2	5
NUMBER OF COLORS	5	3	3

*Stacking lugs promote air circulation and perfect stacking.

**Prorated warranty against manufacturer's defects.

ΔContact your Cambro representative for pricing.

‡Not recommended for heated cart.

CAMWEAR TRAYS

– Camwear Trays

Made of highly durable, virtually unbreakable Camwear.

– Camwear Trays with Non-Slip Surface

Made of highly durable, virtually unbreakable Camwear. The non-slip, clear textured, surface is scratch resistant.

FIBERGLASS TRAYS

– Camtread Trays

– Treadlite Trays

Made of rugged fiberglass interior to provide a tough inner foundation and smooth surface, coupled with polyester resin to resist impact and stains.

POLYPROPYLENE TRAYS

– Polytread Trays

Polytread trays have non-slip rubber surface bonded directly into the tray.



Canteens / Cafeterias / Self-serve



Educational



Food courts / Snack shops / Quick serve



Hospitals



Catering / Banquet Service



Hotel / Room service



Military



Restaurants / Cafes / Brasseries / Pubs / Bars / Clubs

TRAY PRODUCT GUIDE

WOOD TRAYS

LAMINATED TRAYS



RECOMMENDED USE



TRAY DESCRIPTION

Wood Trays with Smooth Surface
Page 234

Wood Trays with Non-Slip Surface
Page 235

Corfu Laminated Trays with Non-Slip Rubber Surface
Page 235

Capri Laminated Trays with Smooth Surface
Pages 236-237

Mykonos Laminated Trays with Non-Slip Surface
Page 238

Madeira Laminated Trays with Textured Wood Surface
Page 239

MATERIAL

Veneer Beechwood

Veneer Beechwood Mahogany + Non-Slip Surface

Laminate + Non-Slip Rubber Surface

Laminate

Laminate + Non-Slip Surface

Laminate

SURFACE

Smooth

Non-Slip

Non-Slip Rubber

Smooth

Non-Slip

Textured

PERFORMANCE

Good

Good

Excellent

Good

Good

Good

PERSONALIZATION

No

No

Yes†

Yes

Yes

No

YEARS WARRANTIED**

3

3

3

3

3

3

STACKING LUGS*

No

No

No

No

No

No

DISHWASHER SAFE

No

No

No

No

No

No

CHEMICAL RESISTANCE

Excellent

Good

Excellent

Excellent

Good

Excellent

DRYING TEST

Good

Good

Good

Good

Good

Good

THERMAL SHOCK RESISTANCE

Good

Good

Good

Good

Good

Good

BREAK RESISTANCE

Good

Good

Good

Good

Good

Good

SCRATCH RESISTANCE

Good

Good

Good

Good

Good

Good

STAIN RESISTANCE

Good

Good

Good

Excellent

Good***

Excellent

HEAT RESISTANCE

-10° to +100°C ‡

-10° to +100°C ‡

-10° to +100°C ‡

-10° to +100°C ‡

-10° to +100°C ‡

-10° to +100°C ‡

NUMBER OF SIZES

14

7

8

22

15

11

NUMBER OF SHAPES

4

3

2

5

3

4

NUMBER OF COLORS

1

1

1

13

6

5

*Stacking lugs allow free air circulation and perfect stacking.

**Prorated warranty against manufacturer's defects.

***Limited stain resistance for Birch (E75).

‡Not recommended for heated cart.

†Only back side of Corfu trays can be personalized.

LAMINATED TRAYS

- Smooth Surface
- Clear Non-Slip Surface

Made of several layers of genuine beechwood veneer / mahogany combined with synthetic resin

molded under high pressure and temperature. The surface is sealed with a double layer of high pressure melamine to allow regular washing.

LAMINATED TRAYS

- Corfu*
- Capri
- Mykonos
- Madeira

Made of compressed layers of melamine saturated paper combined with synthetic resin molded under high pressure and temperature.

The surface is sealed with a double layer of high pressure melamine to allow regular washing.

* Laminated trays have a non-slip rubber surface bonded directly into the tray.

Note: All laminated trays must be dried before stacking.



Canteens / Cafeterias / Self-serve



Catering / Banquet Service



Hotel / Room service





















Restaurants / Cafes / Brasseries / Pubs / Bars / Clubs

Cambro Beechwood Trays, Mahogany Wood Trays and Laminated Trays must be washed by hand with mild soap.

These trays cannot be washed at any time in a commercial dishwasher. They must be dried completely before stacking to avoid warping and void the warranty.

TRAY PRODUCT GUIDE

	POLYPROPYLENE	COMPARTMENT TRAYS			DISPLAY TRAYS	
						
RECOMMENDED USE		  	  		  	
TRAY DESCRIPTION	Fast Food Trays Page 240	Camwear® Trays Pages 241-244	ABS Page 241	Heat Resistant Trays Page 244	Co-Polymer Trays Pages 245	Market Trays Page 245
MATERIAL	Polypropylene	Camwear	ABS	Heat Resistant Plastic	Co-Polymer	Fiberglass Layers + Polyester Resin
SURFACE	Textured	Textured	Textured	Textured	Textured	Smooth
PERFORMANCE	Good	Excellent	Excellent	Excellent	Excellent	Excellent
PERSONALIZATION	Yes Δ Heat Resistance: 80°C	No	No	No	No	No
YEARS WARRANTIED**	3	3	2	2	2	3
STACKING LUGS*	Yes	Yes	Yes	Yes	Yes	Yes
DISHWASHER SAFE	Yes – Minimal	Yes – Extensive	Yes – Extensive	Yes – Extensive	Yes – Minimal	Yes – Extensive
CHEMICAL RESISTANCE	Excellent	Good	Excellent	Very Good	Excellent	Good
DRYING TEST	Good	Excellent	Excellent	Very Good	Excellent	Excellent
THERMAL SHOCK RESISTANCE	Good	Excellent	Good	Very Good	Good	Excellent
BREAK RESISTANCE	Good	Excellent	Good	Very Good	Good	Good
SCRATCH RESISTANCE	Good	Very Good	Very Good	Very Good	Very Good	Good
STAIN RESISTANCE	Good	Very Good	Very Good	Very Good	Very Good	Excellent
HEAT RESISTANCE	-10° to +80°C ‡	-40° to +99°C ‡	-10° to +82°C ‡	-40° to +149°C	-10° to +80°C ‡	-10° to +100°C ‡
NUMBER OF SIZES	4	8	1	1	4	19
NUMBER OF SHAPES	2	7	1	1	3	2
NUMBER OF COLORS	14	10***	6	1	7	5

*Stacking lugs promote air circulation and perfect stacking.

**Prorated warranty against manufacturer's defects.

***Not available for all tray styles.

Δ Contact your Cambro representative for pricing.

‡Not recommended for heated cart.

POLYPROPYLENE TRAYS

– Fast Food Trays

Fast food trays have a textured surface to hide scratches and provides an additional grip to prevent slipping.

COMPARTMENT TRAYS

– Camwear Trays

Made of highly durable, virtually unbreakable Camwear.

– ABS Trays

Made of high impact resistance and heat and chemical resistance ABS.

DISPLAY TRAYS

– Market Trays

Made of high-impact resistant fiberglass that resists odors.



Deli /
Buffet displays



Educational



Food courts /
Snack shops /
Quick serve



Home meal delivery



Military



Prisons /
Corrections

CENTURY™ TEXTURED WOOD TRAYS

SPECIFICATIONS

Material	SMC – high performance fiberglass
Surface Characteristic	Textured / Textured Non-Slip
Performance	Excellent
Stacking Lugs	Yes
Dishwasher Safe	Yes – Extensive
Chemical Resistance	Excellent
Drying Test	Excellent
Shock Resistance	Excellent
Break Resistance	Excellent
Scratch Resistance	Excellent
Stain Resistance	Excellent
Heat Resistance	-40° to +90°C‡



‡Not for use in heated carts.

If you are using Thermo-Chemical Disinfection Equipment, please contact us. We will assist you finding the right tray for your application.

RECOMMENDED USE

High Traffic / Frequent Use

- Hospitals
- Schools
- Universities
- Canteens / Cafeterias / Self-Serve
- Military
- Hotel Room Service

Light Oak (F86)

Brown Oak (F87)

Only available from Cambro European Logistics (CEL), Germany.

Minimum quantity order from CEL:

Non-stock item 288 pieces.
No broken carton.

Dark Oak (F88)

Light Olive (F89)

Brown Olive (F90)

Gray Oak (F91)

Black Mat (110)

CODE	SIZE	CASE PACK
Century Textured Smooth Surface		
VTC2632T	26,5 x 32,5 cm	12
VTC3343T	33 x 43	12
VTC3646T	35,5 x 45,7	12
VTC3253T	32,5 x 53	12
VTC3753T	37 x 53	12



Century Textured Clear Non-Slip Surface		
VTC2632TNS	26,5 x 32,5 cm	12
VTC3343TNS	33 x 43	12
VTC3646TNS	35,5 x 45,7	12
VTC3253TNS	32,5 x 53	12
VTC3753TNS	37 x 53	12



Century Tread Textured Non-Slip Surface		
VTCT2632T	26,5 x 32,5 cm	12
VTCT3343T	33 x 43	12
VTCT3646T	35,5 x 45,7	12
VTCT3253T	32,5 x 53	12
VTCT3753T	37 x 53	12



Color: Black Mat (110).

Century Plus Textured Surface		
VTC2632T	26,5 x 32,5 cm	12
VTC3343T	33 x 43	12
VTC3646T	35,5 x 45,7	12
VTC3253T	32,5 x 53	12
VTC3753T	37 x 53	12



Color: Solid Black (S60).

STOCK PRODUCTS & COLORS AVAILABLE IN OUR EUROPEAN WAREHOUSE

VTC2632T, VTC3343T, VTC3646T, VTC3253T, VTC3753T: (F86), (F87), (F88), (F89), (F90), (F91).
VTCT3343T, VTCT3646T: (110).

For non-stock items, minimum order per size: 288 pieces.

VTC2632T, VTC3343T, VTC3646T, VTC3253T: (S60).

For non-stock items, minimum order per size: 300 pieces.

CENTURY™ FUN TRAYS – CREATE A VIBRANT TABLE TOP WITH COLOURFUL TRAYS

SPECIFICATIONS

	Versa Tray	Versa Lite Tray
Material	SMC – high performance fiberglass	SMC – standard performance reinforced polyester fiberglass reinforced polyester
Surface Characteristic	Smooth	Smooth
Performance	Excellent	Excellent
Stacking Lugs	Yes	Yes
Dishwasher Safe	Yes – Extensive	Yes – Normal
Chemical Resistance	Excellent	Good
Drying Test	Excellent	Excellent
Shock Resistance	Excellent	Good
Break Resistance	Excellent	Good
Scratch Resistance	Excellent	Good
Stain Resistance	Excellent	Good
Heat Resistance*	-40° to +90°C‡	-40° to +90°C‡

‡Not for use in heated carts.

Personalization, see page 208.

*Personalization Heat Resistance: 90°C.



Reinforced polyester corners provide superior corner and edge protection against impact.

VT3646C

Century Fun Trays are made for intensive use. Scratch, stain, chemical and break-resistant, Century Fun trays are available on a pure white tray. Match the tray colour to your décor (dishes, furniture, walls, etc.).

Stacking lugs keep trays stacked securely in place and ensure proper air flow.

Innovative low profile and low corner design increases space utilization of tray surface and customer comfort while eating.

RECOMMENDED USE

High Traffic / Frequent Use

- Hospitals
- Schools
- Universities
- Canteens / Cafeterias / Self-Serve
- Military

Only available from Cambro European Logistics (CEL), Germany.

Minimum quantity order from CEL: Stock item one case, Non-stock item 120 pieces. No broken carton.

Personalization

Possibility to personalize to any PMS colors of your choice.

Minimum quantity: 120 pieces.

Please refer to personalization procedure and color availability in the Personalization section.

For assistance please contact your Cambro representative.

Raspberry on White Tray (F02)

Pearl Grey on White Tray (F04)

Light Oak (F86)

Brown Olive (F90)

CODE	DIMENSIONS	CASE PACK
Versa Trays		
VT1418	35,5 x 45,7 cm	12
VT3343C	33 x 43	12
VT3646C	35,5 x 45,7	12
Versa Lite Trays		
VL1418	35,5 x 45,7	12
VL3343C	33 x 43	12
VL3646C	35,5 x 45,7	12

STOCK PRODUCTS & COLORS AVAILABLE IN OUR EUROPEAN WAREHOUSE

VL3646C: (F02), (F04), (F86)

POLYESTER VERSA TRAYS—

ECOLOGIC SERIES SPECIFICATIONS

Material	Natural material + polyester
Surface Characteristic	Smooth
Performance	Excellent
Stacking Lugs	Yes
Dishwasher Safe	Yes – Extensive
Chemical Resistance	Excellent
Drying Test	Excellent
Shock Resistance	Excellent
Break Resistance	Excellent
Scratch Resistance	Excellent
Stain Resistance	Excellent
Heat Resistance	-40° to +140°C‡



‡Not for use in heated carts.

RECOMMENDED USE

High Traffic / Frequent Use

- Hospitals
- Schools
- Universities
- Canteens / Cafeterias / Self-Serve
- Military

Only available from Cambro
European Logistics (CEL), Germany.

Minimum quantity order from CEL:
Non-stock item 240 pieces.
No broken carton.

Environmentally Friendly



Tray Colors:



CODE	SIZE
Versa Trays – High Profile Shape	
VTE1418	35,5 x 45,7 cm
VTE3343	33 x 43
Versa Trays – Low Profile Shape	
VTE3253	32,5 x 53
VTE3753	37 x 53
Versa Century™ – Low Profile Design Shape	
VTE3646C	35,5 x 45,7
Versa Trays – Flat Edge Shape	
GPE0540	34,4 x 46
GPE3980	37 x 53
GPE4002*	32,5 x 53
GPE4004**	32,5 x 53

Case Pack: 12 *Designed with reinforced corners for automatic off-stacking onto conveyor belt dishwashers. **Textured top surface to reduce sliding of dishes.

POLYESTER VERSA TRAYS PLUS

SPECIFICATIONS

Material	SMC – high performance fiberglass reinforced polyester
Surface Characteristic	Smooth
Performance	Excellent
Stacking Lugs	Yes
Dishwasher Safe	Yes – Extensive
Chemical Resistance	Excellent
Drying Test	Excellent
Shock Resistance	Excellent
Break Resistance	Excellent
Scratch Resistance	Excellent
Stain Resistance	Excellent
Heat Resistance	-40° to +140°C‡



‡Not for use in heated carts.

RECOMMENDED USE

High Traffic / Frequent Use

- Hospitals
- Schools
- Universities
- Canteens / Cafeterias / Self-Serve
- Military

Only available from Cambro
European Logistics (CEL), Germany.

Minimum quantity order from CEL:
Stock item one case, Non-stock item
240 pieces. No broken carton.

STOCK PRODUCTS & COLORS AVAILABLE IN OUR EUROPEAN WAREHOUSE

VT3646C, GP1070, GP4002, GP4004, VT1418:
(S60)

Long Lasting



Tray Color:

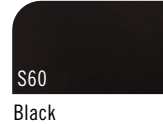

CODE	SIZE
Versa Trays – High Profile Shape	
VT1418	35,5 x 45,7 cm
VT3343	33 x 43
Versa Trays – Low Profile Shape	
VT2632	32,5 x 26,5
VT3253	32,5 x 53
VT3753	37 x 53
Versa Century™ – Low Profile Design Shape	
VT3646C	35,5 x 45,7
Versa Trays – Flat Edge Shape	
GP1070	32,5 x 26,5
GP3980	37 x 53
GP4002*	32,5 x 53
GP4004**	32,5 x 53

Case Pack: 12 *Designed with reinforced corners for automatic off-stacking onto conveyor belt dishwashers. **Textured top surface to reduce sliding of dishes.

POLYESTER VERSA TRAYS WITH SMOOTH SURFACE

SPECIFICATIONS

Material	SMC – High Performance Fiberglass Reinforced Polyester
Surface Characteristic	Smooth
Performance	Excellent
Stacking Lugs	Yes
Dishwasher Safe	Yes – Extensive
Chemical Resistance	Excellent
Drying Test	Excellent
Shock Resistance	Excellent
Break Resistance	Excellent
Scratch Resistance	Excellent
Stain Resistance	Excellent
Heat Resistance*	-40° to +140°C ‡



‡Not for use in heated carts.
Personalization, see page 208.
*Personalization Heat Resistance: 90°C.

RECOMMENDED USE

High Traffic / Frequent Use

- Hospitals
- Schools
- Universities
- Canteens / Cafeterias / Self-Serve
- Military

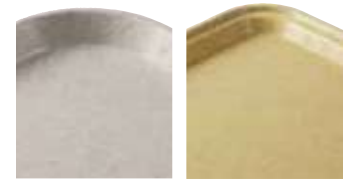

High Profile Shape Low Profile Shape



Low Profile Design Shape Flat Edge Shape

STOCK PRODUCTS & COLORS AVAILABLE IN OUR EUROPEAN WAREHOUSE

VT1418, VT2632: (A72), (A83)
VT3253: (A72), (A83), (A86)
VT3343, VT3646C: (A72)

Minimum quantity order from CEL:
Stock item one case, Non-stock item 120 pieces. No broken carton.

Only available from Cambro European Logistics (CEL), Germany.

CODE	SIZE	CASE PACK
Versa Trays – High Profile Shape		
VT1216	30,5 x 41,5 cm	12
VT1418	35,5 x 45,7	12
VT1418TR – Trapezoid	35,5 x 45,7	12
VT1520	38 x 51,5	12
VT1520TR – Trapezoid	38 x 51,5	12
VT3343	33 x 43	12

Versa Trays – High Profile Shape



CODE	SIZE	CASE PACK
Versa Trays – Low Profile Shape		
VT2632	32,5 x 26,5 cm	12
VT3253	32,5 x 53	12
VT3753	37 x 53	12
VT3853	37,5 x 53	12

Versa Trays – Low Profile Shape



CODE	SIZE	CASE PACK
Versa Century™ Trays – Low Profile Design Shape		
VT3646C	35,5 x 45,7 cm	12
VT3343C	33 x 43	12

Versa Century Trays – Low Profile Design Shape



VT3646C

Innovative low profile and low corner design increases space utilization of tray surface and customer comfort while eating.

POLYESTER VERSA TRAYS WITH SMOOTH SURFACE

CODE	SIZE	CASE PACK
Versa Trays – Flat Edge Shape		
GP0540*	46 x 34,4 cm	12
GP1070*	32,5 x 26,5	12
GP1080*	37 x 26,5	12
GP3074	45 x 32	12
GP3788	39 x 51	12
GP3980*	53 x 37	12
GP4002*	53 x 32,5	12
GP4004**	53 x 32,5	12
GP4701	42,5 x 32,5	12
GP4709	46 x 32,5	12
GP4856*	34,5 x 23	12

*Designed with reinforced corners for automatic off-stacking onto conveyor belt dishwashers.

**Textured top surface to reduce sliding of dishes. Not available in (A72).

Versa Trays – Flat Edge Shape



Tray Colors:



STOCK PRODUCTS & COLORS AVAILABLE IN OUR EUROPEAN WAREHOUSE

GP0540: (A22), (A83), GP1070, GP4709: (A27), GP3980, GP4210: (A86)

GP4002: (A27), (A72), (A83), GP4701: (A33)

Minimum quantity order from CEL:

Stock item one case, Non-stock item 120 pieces. No broken carton.

Versa Trays – Café Trays

CODE	SIZE	CASE PACK
Versa Trays – Café Trays		
GP55653	40 x 27 cm	12
GP55702	26 x 20	12
GP55703	29 x 21	12



Only available from Cambro European Logistics (CEL), Germany.

Versa Trays – Space Saver Trays

CODE	SIZE	CASE PACK
Versa Trays – Space Saver Trays		
GP4210 – Trapezoid	48 x 34 cm	12
GP4410 – Trapezoid	32,5 x 42,5	12
GP4853	42,4 x 32,5	12

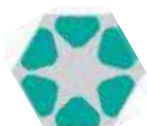

Hexagonal table
Lateral side:
70 cm GP4210



Square table
80 x 80 cm
GP4210



Round table
Diam. 135 cm
GP4853

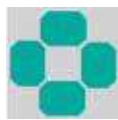

Square Table
95 x 95 cm
GP4853

Polyester Versa Trays VT/GP are not recommended for use in heated meal delivery carts. Please contact Cambro Customer Service or Presswerk Köngen GmbH, with any questions related to proper usage or any special application. Cambro will provide you with clear instructions on correct usage of our trays to ensure you get the maximum life out of our products.

*Colors Pebbled Grey A19 and Charcoal A72 will show scratches if not handled properly.

POLYESTER VERSA LITE TRAYS WITH SMOOTH SURFACE

SPECIFICATIONS

Material	SMC – standard performance fiberglass reinforced polyester
Surface Characteristic	Smooth
Performance	Excellent
Stacking Lugs	Yes
Dishwasher Safe	Yes – Normal
Chemical Resistance	Good
Drying Test	Excellent
Shock Resistance	Good
Break Resistance	Good
Scratch Resistance	Good
Stain Resistance	Good
Heat Resistance*	-40° to +130°C‡



‡Not for use in heated carts.
Personalization, see page 208.
*Personalization Heat Resistance: 90°C.

RECOMMENDED USE

Moderate Traffic / Economic Priority

- Schools
- Universities
- Canteens / Cafeterias / Self-Serve
- Military
- Hotel Room Service

Only available from Cambro European Logistics (CEL), Germany.

STOCK PRODUCTS & COLORS AVAILABLE IN OUR EUROPEAN WAREHOUSE

GL0540: (A22), GL1070: (A27), GL3980: (A20)
GL4002: (A20), (A83), (A86)

Minimum quantity order from CEL:
Stock item one case, Non-stock item 120 pieces. No broken carton.



High Profile Shape Low Profile Shape

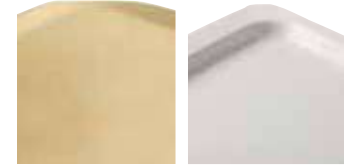

Low Profile Design Shape Flat Edge Shape



Low Profile Flat Edge Shape

CODE	SIZE
Versa Lite Trays – Flat Edge Shape	
GL0540†	46 x 34,4 cm
GL1070†	32,5 x 26,5
GL1080†	37 x 26,5
GL3074	45 x 32
GL3980†	53 x 37
GL4002†	53 x 32,5
GL4060	40 x 60
GL4701	42,5 x 32,5

Case Pack: 12

†Designed with reinforced corners for automatic off-stacking onto conveyor belt dishwashers.

Versa Lite Trays – Flat Edge Shape



GL4002

Versa Lite Trays – Space Saver Trays

CODE	SIZE
Versa Lite Trays – Space Saver Trays	
GL4210 – Trapezoid	48 x 34 cm

Case Pack: 12

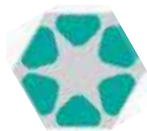

Hexagonal table
Lateral side:
70 cm GL4210



Square table
80 x 80 cm
GL4210



GL4210

POLYESTER VERSA LITE TRAYS WITH SMOOTH SURFACE

CODE	SIZE
Versa Lite Trays – High Profile Shape	
VL1014	27 x 35 cm
VL1216	30,5 x 41,5
VL3343	33 x 43
VL1418	35,5 x 45,7
VL1418TR – Trapezoid	35,5 x 46
VL1520	38 x 51,5
VL1520TR – Trapezoid	38 x 51,5

Case Pack: 12

Versa Lite Trays – High Profile Shape



VL1418

Only available from Cambro European Logistics (CEL), Germany.

STOCK PRODUCTS & COLORS AVAILABLE IN OUR EUROPEAN WAREHOUSE

VL1418: (A20), (A21), (A22), (A27), (A86)
 VL3253: (A20), (A86), VL3343: (A20), (A21)
 VL3343C: (A20), VL3646C: (A27)
 VL1014: (A20), (A27)

Minimum quantity order from CEL:
 Stock item one case, Non-stock item 120 pieces. No broken carton.

CODE	SIZE
Versa Lite Trays – Low Profile Flat Edge Shape	
GL220P	32,5 x 53 cm
GL210P	37 x 53

Case Pack: 12

Versa Lite Trays – Low Profile Flat Edge Shape



GL210P

GL220P

CODE	SIZE
Versa Lite Trays – Low Profile Shape	
VL2632	32,5 x 26,5 cm
VL3253	32,5 x 53
VL3753	37 x 53

Case Pack: 12

Versa Lite Trays – Low Profile Shape



VL3753

Tray Colors:



A20
Speckled Smoke



A21
Speckled Mocha



A22
Sahara

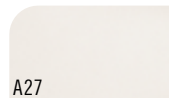

A27
Light Grey

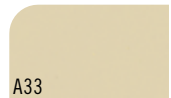

A33
Pearl White



A83
Granite

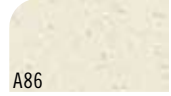

A86
Terrazzo

CODE	SIZE
Versa Lite Century™ Trays – Low Profile Design Shape	
VL3646C	35,5 x 45,7 cm
VL3343C	33 x 43

Case Pack: 12

Versa Lite Century Trays – Low Profile Design Shape



VL3646C



Innovative low profile and low corner design increases space utilization of tray surface and customer comfort while eating.

POLYESTER VERSA LITE TRAYS WITH NON-SLIP RUBBER SURFACE

SPECIFICATIONS

Material	SMC – standard performance fiberglass reinforced polyester + non-slip rubber
Surface Characteristic	Non-Slip Rubber
Performance	Excellent
Stacking Lugs	Yes
Dishwasher Safe	Yes – Normal
Chemical Resistance	Good
Drying Test	Excellent
Shock Resistance	Good
Break Resistance	Good
Scratch Resistance	Good
Stain Resistance	Good
Heat Resistance	-40° to +100°C‡



‡Not for use in heated carts.

RECOMMENDED USE

Moderate Traffic / Economic Priority

- Banquet Service
- Restaurant / Cafes
- Bars / Clubs / Pubs
- Catering
- Brasseries

Only available from Cambro European Logistics (CEL), Germany and Cambro Ūzay Bulgaria.

Minimum quantity order from CEL:
Stock item one case, Non-stock item 120 pieces. No broken carton.

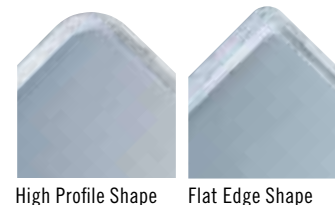

STOCK PRODUCTS & COLORS
AVAILABLE IN OUR EUROPEAN
WAREHOUSE

GL4002RNS: (A83)



CODE	DIA / SIZE	CASE PACK
Versa Lite Trays – High Profile Shape		
VL1418RNS	35,5 x 45,7 cm	12
Versa Lite Trays – Flat Edge Shape		
GL1070RNS*	32,5 x 26,5	12
GL4002RNS*	53 x 32,5	12
GL3980RNS*	53 x 37	12
Versa Lite Tray – Cafe Trays		
VL2129RNS	21 x 29	12
VL3200RNS	∅ 32	12
VL3600RNS	∅ 36	12

*Designed with reinforced corners for automatic off-stacking onto conveyor belt dishwashers.

Patterns and
Tray Base Colors:



DÉCOR SERIES CAMTRAYS®

- Woodgrain textured surface creates the look feel of real wood.
- Durability of the classic Camtray.
- Ideal for upscale employee feeding, restaurant, cafeteria, schools, food courts and hospitals.
- Personalize a portion or an entire tray surface with a full color logo or design.
- Commercial dish washer safe.

Colors: Charcoal Grey (815), Light Olive (820), Dark Oak (825), Light Oak (830).

Personalization with a minimum order of 144 trays.



CODE	DIMENSIONS	CASE PACK
1216DC	30,5 x 41,5 cm	12
1418DC	35,5 x 45,7	12
1520DC	38 x 51	12

Charcoal Grey (815)

Light Olive (820)

DÉCOR SERIES EPICREAD™ CAMTRAYS

- The Décor Series design and texture with our clear EpicTread non-slip surface.
- Perfect for busy cafeterias to reduce food and dish spills.
- An excellent solution for hospital foodservice to provide a beautiful patient tray presentation without a paper tray mat.
- Personalize a portion or an entire tray surface with a full color logo or design.
- Commercial dish washer safe.

Colors: Charcoal Grey (815), Light Olive (820), Dark Oak (825), Light Oak (830).

Personalization with a minimum order of 144 trays.



Dark Oak (825)

Light Oak (830)

CODE	DIMENSIONS	CASE PACK
1216DCET	30,5 x 41,5 cm	12
1418DCET	35,5 x 45,7	12
1520DCET	38 x 51	12

CAMTRAYS® FIBERGLASS TRAYS WITH SMOOTH SURFACE

SPECIFICATIONS

Material	Fiberglass layers + polyester resin
Surface Characteristic	Smooth
Performance	Excellent
Stacking Lugs	Yes
Dishwasher Safe	Yes – Extensive
Chemical Resistance	Good
Drying Test	Excellent
Shock Resistance	Excellent
Break Resistance	Excellent
Scratch Resistance	Excellent
Stain Resistance	Excellent
Heat Resistance	-10° to +100°C‡

†Available in Group I colors and patterns and Group III patterns.

‡Not for use in heated carts. Personalization, see page 208.

Available in Group I colors and patterns except Doily.

*Special order item not carried in stock – non-returnable.

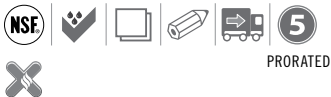

RECOMMENDED USE

High Traffic / Frequent Use

- Hospitals
- Schools
- Universities
- Canteens / Cafeterias / Self-Serve
- Military
- Hotel Room Service

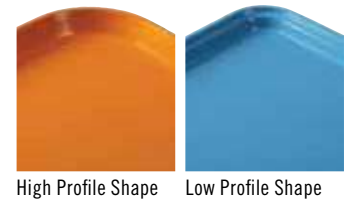

High Profile Shape

Low Profile Shape

STOCK PRODUCTS & COLORS AVAILABLE IN OUR EUROPEAN WAREHOUSE

1216: (204)



CODE	SIZE	CASE PACK
Rectangular – High Profile Shape		
810†	20,5 x 25 cm	12
915†	22 x 38	12
926*†	22,5 x 65 x 2,5	12
1014†	Made in USA/China 27 x 35	12
1015*	26 x 38	24
1116*	27,5 x 40,5	24
1216†	Made in USA/China 30,5 x 41,5	12
1313†	33 x 33	12
1318*†	32 x 45 x 3	12
1418†	Made in USA/China 35,5 x 45,7	12
1520†	Made in USA/China 38 x 51,5	12
1622†	40,5 x 56	12
16225*†	42 x 57	12
1826†	45,5 x 65,5	6
Rectangular – Low Profile Shape		
46†	11 x 15	12
57*†	12,5 x 18	12
2025*†	53 x 65	6
3253	Made in USA/China 32 x 53	12



CAMTRAYS® FIBERGLASS TRAYS WITH SMOOTH SURFACE

CODE	SIZE	CASE PACK
Metric Rectangular – High Profile Shape		
3242	31,9 x 41,9 cm	12
3853*	37,5 x 53	12
Metric Rectangular – Low Profile Shape		
2632*	26,5 x 32,5	12
3046*	30 x 46	12
3343	33 x 43	12
3753*	37 x 53	12
Camtray with Handles		
1418H*❖	35,5 x 45,7	12
1520H*❖	38 x 51,5	12

Metric Rectangular



*Special order item not carried in stock – non-returnable.

❖Available in Group I colors only.

1418H and 1520H available in Group I colors only and covered by 2 Year prorated warranty against manufacturer's defects.

NSF listed for non-direct food contact only.

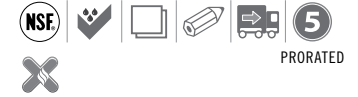

Camtray with Handles



Personalization, see page 208.

1418H and 1520H available in four color printing process only. Please refer to Fiberglass Tray Personalization section for details.

STOCK PRODUCTS & COLORS AVAILABLE IN OUR EUROPEAN WAREHOUSE

3242: (110)



Trapezoid



CODE	DIA / SIZE	CASE PACK
Trapezoid – High Profile Shape		
1418TR*†	35,5 x 45,7 cm	12
1422TR*†	35,5 x 56	12
Trapezoid – Low Profile Shape		
1520TR*†	37 x 49,5	12
Oval – Low Profile Shape		
2500*	49 x 61	6
2700*	56 x 68,5	6
Round – High Profile Shape		
900*	ø 23	12
1000*	ø 25,5	12
1100	ø 28	12
1200*	ø 30,5	12
1300*	ø 33	12
1400	ø 35,5	12
1600	ø 40,5	12
Round – Low Profile Shape		
1550*	ø 40,5	12
1950*	ø 49,5	12

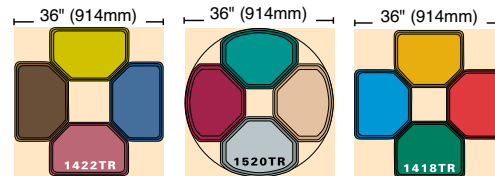

†Available in Group I colors and patterns and Group III patterns.

Available in Group I colors and patterns except Doily.

*Special order item not carried in stock – non-returnable.

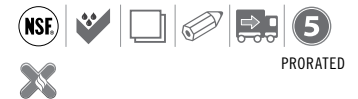

Oval and Round



CAMTRAY® GROUP I COLORS

Colors listed alphabetically. See numerical reference on following page.



Amazon Blue



Antique Parchment



Bay Leaf Brown



Black



Blush



Brazil Brown



Burgundy Wine



Cambro Red



Cameo Yellow



Cherry Red



Citrus Orange



Cottage White



Dark Peach



Desert Tan



Earthen Gold



Ever Red

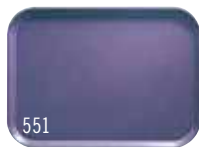

Grape



Horizon Blue



Key Lime



Lemon Chiffon



Light Peach



Lime-ade



Mustard



Olive Green



Orange Pizazz



Pearl Grey



Raspberry Cream



Real Rust



Robin Egg Blue



Sherwood Green



Signal Red



Sky Blue



Slate Blue



Suede Brown



Taupe



Teal



Tuscan Gold



White

Due to the catalog printing process, the colors & patterns shown may not be exact.
Contact Cambro or a Cambro representative for a color chip.

CAMTRAY® GROUP I PATTERNS

Galaxy

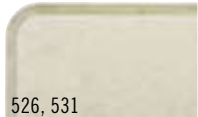

526, 531
Antique Parchment
(526 Gold), (531 Silver)

Swirl



270
Black & Gold 



277
Grey 

Doily





241
Antique Parchment 

Abstract

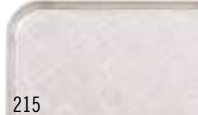

214
Tan 



215
Grey 

 Trays are non-returnable.



CAMTRAY GROUP III – WOOD

Wood



308
Burma Teak 



304
Country Oak 



301
Dark Basketweave 



309
Java Teak 

Linen



329
Toffee 



302
Light Basketweave 



303
Light Butcher Block 



307
Light Elm 



204
Rattan 

 Trays are non-returnable.

CAMTRAY GROUP I COLORS – NUMERICAL REFERENCE BY COLOR CODE

Antique Parchment (101),
Desert Tan (104), Horizon Blue (105),
Light Peach (106), Pearl Gray (107),
Black (110), Lime-ade (113),
Brazil Brown (116), Dark Peach (117),
Sherwood Green (119),
Amazon Blue (123), White (148),

Tuscan Gold (171), Sky Blue (177),
Taupe (199), Citrus Orange (220),
Ever Red (221) Orange Pizazz (222),
Slate Blue (401), Blush (409),
Raspberry Cream (410),
Teal (414), Olive Green (428),
Key Lime (429), Real Rust (501),

Mustard (504), Cherry Red (505),
Suede Brown (508), Signal Red (510),
Bayleaf Brown (513),
Earthen Gold (514),
Robin Egg Blue (518),
Cambro Red (521),
Burgundy Wine (522),

Lemon Chiffon (536),
Cameo Yellow (537),
Cottage White (538), Grape (551).

Due to the catalog printing process, the colors & patterns shown may not be exact.
Contact Cambro or a Cambro representative for a color chip.

EPICTREAD™ TRAYS

SPECIFICATIONS

Material	Fiberglass Layers + Non-Slip, Water Repellent Surface
Surface Characteristic	Non-Slip Surface
Performance	Good
Stacking Lugs	Yes
Dishwasher Safe	Yes – Normal
Chemical Resistance	Good
Drying Test	Good
Shock Resistance	Good
Break Resistance	Good
Scratch Resistance	Good
Stain Resistance	Good
Heat Resistance	-10° to +90°C‡



PRORATED

‡Not for use in heated carts.
Made in China

RECOMMENDED USE

Mild Use / Emphasis on style with limited washing

- Banquet Service
- Restaurants / Cafes
- Bars / Clubs / Pubs
- Catering
- Brasseries



1600ET



1520ET

Black (110)

Dark Brown (167)

Dark Green (206)

Dark Burgundy Wine (207)

Spanish Blue (503)

Cambro Red (521)

CODE	DIA / SIZE	CASE PACK
Rectangular		
1014ET	27 x 35 cm	12
1216ET	30,5 x 41,5	12
1418ET	35,5 x 45,5	12
1520ET	38 x 51,5	12
Round		
1400ET	ø 39	12
1600ET	ø 43,7	12



DIETARY TRAYS

SPECIFICATIONS

Material	Fiberglass layers + polyester resin
Surface Characteristic	Smooth
Performance	Excellent
Stacking Lugs	Yes
Dishwasher Safe	Yes – Extensive
Chemical Resistance	Good
Drying Test	Excellent
Shock Resistance	Excellent
Break Resistance	Good
Scratch Resistance	Good
Stain Resistance	Excellent
Heat Resistance	-10° to +100°C‡

‡Not for use in heated carts.

CAMLITE® TRAYS

SPECIFICATIONS

Material	Fiberglass layers + polyester resin
Surface Characteristic	Smooth
Performance	Excellent
Stacking Lugs	Yes
Dishwasher Safe	Yes – Extensive
Chemical Resistance	Good
Drying Test	Excellent
Shock Resistance	Excellent
Break Resistance	Good
Scratch Resistance	Good
Stain Resistance	Excellent
Heat Resistance	-10° to +100°C‡

‡Not for use in heated carts.

RECOMMENDED USE

High Traffic / Frequent Use
– Hospitals
– Schools
– Universities
– Canteens / Cafeterias / Self-Serve
– Military
– Hotel Room Service

Available in Group I colors and patterns and Group III Patterns.

*Special order item not carried in stock – non-returnable.



RECOMMENDED USE

High Traffic / Frequent Use
– Hospitals
– Schools
– Universities
– Canteens / Cafeterias / Self-Serve
– Military
– Hotel Room Service

Colors: Rose Red (163), Yellow (145), Green (162), Blue (142), Tan (161), Steel White (676), Steel Red (675), Steel Blue (674), Black (110).

12 dozen minimum order required for any special color orders.



CODE	SIZE	CASE PACK
Dietary Trays – Low Profile Shape		
1216D*	30,5 x 41,5 cm	12
1219D*	30,5 x 48,3	12
1220D*	30,5 x 51	12
1222D*	30,5 x 56	12
1418D*	35,5 x 45,7	12
1520D*	38 x 51,3	12

CODE	SIZE	CASE PACK
Rectangular Camlite Trays – High Profile Shape		
1014CL	27 x 35 cm	12
1216CL	30,5 x 41,5	12
1418CL	35,5 x 45,7	12
1520CL	38 x 51,5	12
1826CL	45,5 x 65,5	12
Rectangular Camlite Trays – Low Profile Shape		
3253CL	32,5 x 53	12

CAMWEAR® TRAYS

SPECIFICATIONS

Material	Camwear
Surface Characteristic	Textured
Performance	Excellent
Stacking Lugs	Yes
Dishwasher Safe	Yes – Extensive
Chemical Resistance	Good
Drying Test	Excellent
Shock Resistance	Excellent
Break Resistance	Excellent
Scratch Resistance	Very Good
Stain Resistance	Very Good
Heat Resistance	-40° to +99°C‡



‡Not for use in heated carts.

CAMWEAR TRAYS WITH NON-SLIP SURFACE

SPECIFICATIONS

Material	Camwear
Surface Characteristic	Non-Slip
Performance	Excellent
Stacking Lugs	Yes
Dishwasher Safe	Yes – Extensive
Chemical Resistance	Good
Drying Test	Excellent
Shock Resistance	Excellent
Break Resistance	Excellent
Scratch Resistance	Good
Stain Resistance	Good
Heat Resistance	-40° to +82°C‡



‡Not for use in heated carts.

RECOMMENDED USE

Moderate Traffic / Economic Priority

- Schools
- Universities
- Canteens / Cafeterias / Self-Serve
- Military
- Quick Serve Restaurants
- Food Courts / Snack Shops

1418CW, 1520CW, 1418TRCW Colors: Blue (168), Beige (133).

1520CWH Colors: Black (110), Smoked Metal (485), Dark Cranberry (488).

NSF listed for non-direct food contact only.

RECOMMENDED USE

Moderate Traffic / Economic Priority

- Schools / Universities
- Canteens / Cafeterias / Self-Serve
- Military
- Quick Serve Restaurants
- Food Courts / Snack Shops
- Restaurants / Cafes
- Brasseries
- Hotels / Room Service
- Hospitals

Colors: Black (110), Smoked Metal (485), Dark Cranberry (488).

NSF listed for non-direct food contact only.



Black (110)

Dark Cranberry (488)

Smoked Metal (485)

CODE	SIZE	CASE PACK
Rectangular – High Profile Shape		
1418CW	35,5 x 45,7 cm	12
1520CW	38 x 51	12
Rectangular With Handles – High Profile Shape		
1520CWH	38 x 51	12
Trapezoid – High Profile Shape		
1418TRCW	35,5 x 45,7	12

CODE	SIZE	CASE PACK
Rectangular – High Profile Shape		
1418CWNS	35,5 x 45,7 cm	12
1520CWNS	38 x 51	12
Rectangular With Handles – High Profile Shape		
1418CWNSH	35,5 x 45,7	12
1520CWNSH	38 x 51	12



CAMTREAD® FIBERGLASS TRAYS WITH NON-SLIP RUBBER SURFACE

SPECIFICATIONS

Material	Fiberglass layers + polyester resin + non-slip rubber surface molded from edge-to-edge
Surface Characteristic	Non-Slip Rubber
Performance	Excellent
Stacking Lugs	Yes
Dishwasher Safe	Yes – Extensive
Chemical Resistance	Good
Drying Test	Excellent
Shock Resistance	Excellent
Break Resistance	Good
Scratch Resistance	Excellent
Stain Resistance	Good
Heat Resistance	-10° to +80°C‡

Orders for non-standard Camtread Tray colors will be handled by special quotation only.

*Special order item not carried in stock – non-returnable.

Not for use in heated carts.

Personalization see page 209 for size and detail.



RECOMMENDED USE

High Traffic / Frequent Use

- Banquet Service
- Restaurants / Cafes
- Bars / Clubs / Pubs
- Catering
- Brasseries

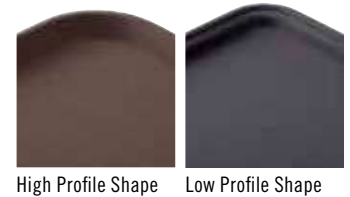

STOCK PRODUCTS & COLORS AVAILABLE IN OUR EUROPEAN WAREHOUSE

1014CT, 1100CT, 1216CT, 1800CT, 1826CT, 2500CT, 2900CT, 3253CT: (110)
1400CT, 1418CT, 1600CT, 2700CT: (110), (138)

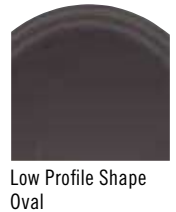

Tray Colors:



CODE	DIA / SIZE	CASE PACK
Round – High Profile Shape		
900CT*	ø 23 cm	12
1100CT	ø 28	12
1400CT	ø 35,5	12
1600CT	ø 40,5	12
1800CT	ø 45	6
Round – Low Profile Shape		
1550CT*	ø 40,5	12
1950CT*	ø 49,5	12
Oval – Low Profile Shape		
2500CT	49 x 59	6
2700CT	56 x 68,5	6
2900CT	73,5 x 60	6
Rectangular – High Profile Shape		
1014CT*	27 x 35	12
1216CT	30,5 x 41,5	12
1418CT	35,5 x 45,7	12
1520CT*	38 x 51,5	12
1622CT*	40,5 x 56	12
1826CT	45 x 65	6
Rectangular – Low Profile Shape		
3253CT	32,5 x 53	12



TREADLITE™ TRAYS

SPECIFICATIONS

Material	Fiberglass layers + polyester resin + Non-slip rubber surface
Surface Characteristic	Non-Slip rubber surface
Performance	Good
Stacking Lugs	Yes
Dishwasher Safe	Yes – Extensive
Chemical Resistance	Good
Drying Test	Good
Shock Resistance	Good
Break Resistance	Good
Scratch Resistance	Good
Stain Resistance	Good
Heat Resistance	-10° to +80°C‡



‡Not for use in heated carts.

RECOMMENDED USE

Moderate Traffic / Economic Priority

- Brasseries
- Restaurants / Cafes
- Bars / Clubs / Pubs

POLYTREAD® TRAYS

SPECIFICATIONS

Material	Polypropylene + Non-Slip rubber surface
Surface Characteristic	Non-Slip rubber surface
Performance	Good
Stacking Lugs	Yes
Dishwasher Safe	Yes – Minimal
Chemical Resistance	Good
Drying Test	Good
Shock Resistance	Good
Break Resistance	Good
Scratch Resistance	Good
Stain Resistance	Good
Heat Resistance	-10° to +80°C‡



‡Not for use in heated carts.

RECOMMENDED USE

Moderate Traffic / Economic Priority

- Brasseries
- Restaurants / Cafes
- Bars / Clubs / Pubs



High Profile Shape

Tray Colors:

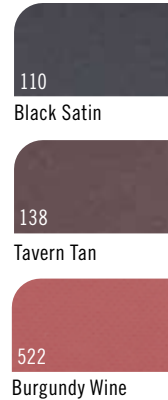

CODE	DIA	CASE PACK
Round – High Profile Shape		
1400TL	ø 35,5 cm	12
1600TL	ø 40,5	12



Tray Colors:

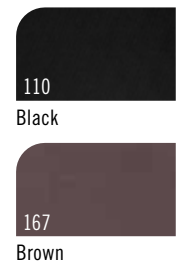

CODE	DIA / SIZE	CASE PACK
Round – High Profile Shape		
PT1100	ø 28 cm	12
PT1400	ø 35,5	12
PT1600	ø 40,5	12
Rectangular – High Profile Shape		
PT1014	27 x 34,5	24
PT1216	30 x 41,5	24
PT1418	36 x 46	12

BEECHWOOD TRAYS WITH SMOOTH SURFACE SPECIFICATIONS

Material	Veneer Beechwood
Surface Characteristic	Smooth
Performance	Good
Stacking Lugs	No
Dishwasher Safe	No*
Chemical Resistance	Good
Drying Test	Good
Shock Resistance	Good
Break Resistance	Good
Scratch Resistance	Good
Stain Resistance	Good
Heat Resistance	-10° to +100°C‡



‡Not for use in heated carts
*Washing Instruction

RECOMMENDED USE

Mild Use / Emphasis on style with limited washing

- Banquet Service
- Restaurants / Cafes
- Catering

Only available from Cambro European Logistics (CEL), Germany.



Tray Color:



BEECHWOOD TRAYS WITH NON-SLIP SURFACE SPECIFICATIONS

Material	Veneer Beechwood
Surface Characteristic	Non-Slip Surface
Performance	Good
Stacking Lugs	No
Dishwasher Safe	No*
Chemical Resistance	Good
Drying Test	Good
Shock Resistance	Good
Break Resistance	Good
Scratch Resistance	Good
Stain Resistance	Good
Heat Resistance	-10° to +100°C‡



‡Not for use in heated carts
*Washing Instruction

RECOMMENDED USE

Mild Use / Emphasis on style with limited washing

- Banquet Service
- Restaurants / Cafes
- Bars / Clubs / Pubs
- Catering
- Brasseries

Only available from Cambro European Logistics (CEL), Germany.

**STOCK PRODUCTS & COLORS
AVAILABLE IN OUR EUROPEAN
WAREHOUSE**

PH556056: (000)

Minimum quantity order from CEL:
Stock item one case, Non-stock item
120 pieces. No broken carton.



Tray Color:



CODE	DIA / SIZE	CASE PACK
Rectangular – 60 Series		
PH556010	45 x 32 cm	12
PH556020	58 x 38	12
PH556030	63 x 40	12
PH556040	70 x 45	12
PH556050	75 x 48	12
Rectangular – 65 Series		
PH556510	27 x 20	12
PH556520	33 x 23	12
Oval		
PH557010	23 x 16	24
PH557020	26 x 20	24
PH557030	29 x 21	24
PH557040	33 x 24	24
Round Beer Tray		
PH558510	ø 32	12
PH558520	ø 36	12
PH558530	ø 42	12

CODE	DIA / SIZE	CASE PACK
Rectangular – 60 Series		
PH556016	45 x 32 cm	12
PH556026	58 x 38	12
PH556036	63 x 40	12
PH556046	70 x 45	12
PH556056	75 x 48	12
Rectangular – 65 Series		
PH556516	27 x 20	12
PH556526	33 x 23	12
Oval		
PH557016	23 x 16	24
PH557026	26 x 20	24
PH557036	29 x 21	24
PH557046	33 x 24	24
Round Beer Tray		
PH558516	ø 32	12
PH558526	ø 36	12
PH558536	ø 42	12

MAHOGANY WOOD TRAYS WITH NON-SLIP SURFACE SPECIFICATIONS

Material	Mahogany Veneer
Surface Characteristic	Non-Slip Surface
Performance	Good
Stacking Lugs	No
Dishwasher Safe	No*
Chemical Resistance	Good
Drying Test	Good
Shock Resistance	Good
Break Resistance	Good
Scratch Resistance	Good
Stain Resistance	Good
Heat Resistance	-10° to +100°C‡



‡Not for use in heated carts.

*Washing Instruction

RECOMMENDED USE

Mild Use / Emphasis on style with limited washing

- Banquet Service
- Restaurants / Cafes
- Bars / Clubs / Pubs
- Catering
- Brasseries

Only available from Cambro European Logistics (CEL), Germany and Cambro Özay Bulgaria.



Mahogany (W02)

CODE	DIA / SIZE	CASE PACK
Rectangular		
MW3245	32 x 45 cm	12
MW3858	37,5 x 57,5	12
MW3646	36 x 46	12
Oval		
MW2129	21 x 29	12
Round Beer Tray		
MW3200	ø 32	12
MW3600	ø 36	12
MW4200	ø 42	12

CORFU – LAMINATED TRAYS WITH NON-SLIP RUBBER SURFACE SPECIFICATIONS

Material	Laminate + non-slip rubber surface
Surface Characteristic	Non-Slip rubber surface
Performance	Excellent
Stacking Lugs	No
Dishwasher Safe	No*
Chemical Resistance	Excellent
Drying Test	Good
Shock Resistance	Good
Break Resistance	Good
Scratch Resistance	Good
Stain Resistance	Good
Heat Resistance	-10° to +100°C‡



PRORATED

‡Not for use in heated carts.

Note: All laminated trays must be dried before stacking.

Personalization, see page 209.

RECOMMENDED USE

Normal Use / Emphasis on style with limited washing

- Canteens / Cafeterias / Self-Serve
- Banquet Service
- Restaurants / Cafes
- Bars / Clubs / Pubs
- Catering

Only available from Cambro European Logistics (CEL), Germany and Cambro Özay Bulgaria.



Tray Color:



Black on Grey

Minimum quantity order from CEL: Stock item one case, Non-stock item 120 pieces. No broken carton.

STOCK PRODUCTS & COLORS AVAILABLE IN OUR EUROPEAN WAREHOUSE

C03800, C04300, C03646: (D01)

*Washing Instruction

CODE	DIA / SIZE	CASE PACK
Rectangular		
C02632	26,5 x 32,5 cm	12
C03253	32,5 x 53	12
C03343	33 x 43	12
C03646	36 x 46	12
C03753	37 x 53	12
Round		
C03200	ø 32	12
C03800	ø 38	12
C04300	ø 43	12

CAPRI – LAMINATED TRAYS WITH SMOOTH SURFACE

SPECIFICATIONS

Material	Laminate
Surface Characteristic	Smooth
Performance	Good
Stacking Lugs	No
Dishwasher Safe	No*
Chemical Resistance	Excellent
Drying Test	Good
Shock Resistance	Good
Break Resistance	Good
Scratch Resistance	Good
Stain Resistance	Excellent
Heat Resistance	-10° to +100°C‡



‡Not for use in heated carts.

Note: All laminated trays must be dried before stacking.

Personalization, see page 209.

*Washing Instruction



Capri – Rectangular



Capri – Round



Tray Pattern:
Thank You (E01)
available in
CA1300 only.

RECOMMENDED USE

Moderate Traffic / Economic Priority

- Canteens / Cafeterias / Self-Serve
- Hotel Room Service
- Restaurants / Cafes
- Bars / Clubs / Pubs
- Catering
- Brasseries

Only available from Cambro European Logistics (CEL), Germany and Cambro Özyay Bulgaria.

STOCK PRODUCTS & COLORS AVAILABLE IN OUR EUROPEAN WAREHOUSE

CA3646: (E73), (E76), (E78), (E82)
CA3343: (E73), (E75), (E76), (E82)
CA3253: (E76), (E82)
CA3753: (E76)

Minimum quantity order from CEL:

Stock item one case, Non-stock item 120 pieces. No broken carton.

CODE	DIMENSIONS	CASE PACK
Rectangular		
CA2028	20 x 28 cm	24
CA2632	26,5 x 32,5	24
CA2738	27 x 38	24
CA2836	28 x 36	24
CA3244	32 x 44	24
CA3253	32,5 x 53	24
CA3343	33 x 43	24
CA3446	34 x 46	24
CA3646	36 x 46	24
CA3748	37 x 48	24
CA3753	37 x 53	24
CA3952	39 x 52	24
CA4361	43 x 61	12
Round		
CA1300	ø 13	24
CA3200	ø 32	24
CA3800	ø 38	24
CA4300	ø 43	24
Trapezoid		
CA3247TR	32 x 47	24
Oval		
CA1623	16 x 23	24
CA2026	20 x 26,5	24
CA2129	21 x 29	24
Rectangular with Handles		
CA4064H*	40 x 64	12

*Only available in Walnut (E76), Venge (E84) and Brushed Steel (E85).

CAPRI – LAMINATED TRAYS WITH SMOOTH SURFACE



Walnut
(E76)

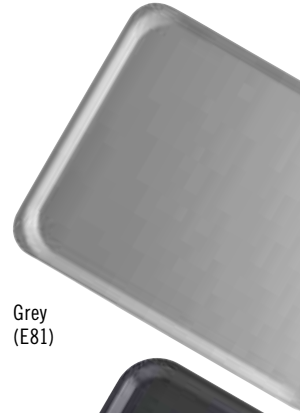

Grey
(E81)



Charcoal
Granite (E82)



Venge
(E84)



Brushed
Steel (E85)

Light
Oak (E86)



Brown
Oak (E87)



Dark
Oak (E88)

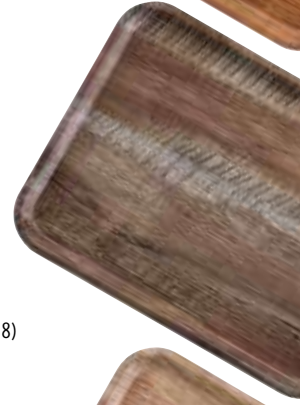

Light
Olive (E89)



Brown
Olive (E90)



Mahogany
(E73)



Teak
(E77)



White
(E78)



Birch
(E75)



Black
(E79)





MYKONOS – LAMINATED TRAYS WITH NON-SLIP SURFACE

SPECIFICATIONS

Material	Laminate + Non-Slip Surface
Surface Characteristics	Non-Slip Surface
Performance	Good
Stacking Lugs	No
Dishwasher Safe	No**
Chemical Resistance	Good
Drying Test	Good
Shock Resistance	Good
Break Resistance	Good
Scratch Resistance	Good
Stain Resistance	Good*
Heat Resistance	-10° to +100°C‡



Personalization,
see page 209.

PRORATED

‡Not for use in heated carts.

Note: All laminated trays must be dried before stacking.

*Limited stain resistance for Birch (E75).

**Washing Instruction

RECOMMENDED USE

Moderate Use / Emphasis on Style with Limited Washing

- Banquet Services
- Restaurants / Cafes
- Bars / Clubs / Pubs
- Catering

Only available from Cambro European Logistics (CEL), Germany and Cambro Ūzay Bulgaria.

Minimum quantity order from CEL: Stock item one case, Non-stock item 120 pieces. No broken carton.

STOCK PRODUCTS & COLORS AVAILABLE IN OUR EUROPEAN WAREHOUSE

MY3253, MY4361: (E76)
MY3343: (E75), (E76), (E82)
MY3646: (E73), (E76)



Tray Colors:

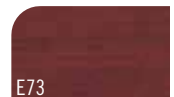

E73 Mahogany

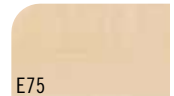

E75 *Birch



E76 Walnut



E77 Teak

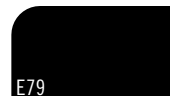

E79 Black



E82 Charcoal Granite

CODE	DIA / SIZE	CASE PACK
Rectangular		
MY2632	26,5 x 32,5 cm	24
MY2738	27 x 38	24
MY3244	32 x 44	24
MY3253	32,5 x 53	24
MY3343	33 x 43	24
MY3446	34 x 46	24
MY3646	36 x 46	24
MY3753	37 x 53	24
MY3952	39 x 52	24
MY4361	43 x 61	12
Oval		
MY2026	20 x 26,5	24
MY2129	21 x 29	24
Round		
MY3200	ø 32	24
MY3800	ø 38	24
MY4300	ø 43	24

MADEIRA – LAMINATED TRAYS WITH TEXTURED WOOD SURFACE

SPECIFICATIONS

Material	Laminate
Surface Characteristics	Textured – Top and Bottom
Performance	Good
Stacking Lugs	No
Dishwasher Safe	No*
Chemical Resistance	Excellent
Drying Test	Good
Shock Resistance	Good
Break Resistance	Good
Scratch Resistance	Good
Stain Resistance	Excellent
Heat Resistance	-10° to +100°C‡



Personalization,
see page 209.

PRORATED

‡Not for use in heated carts.

Note: All laminated trays must be dried before stacking.

*Washing Instruction

RECOMMENDED USE

Moderate Traffic / Economic Priority

- Canteens / Cafeterias / Self-Serve
- Hotel Room Service
- Restaurants / Cafes
- Bars / Clubs / Pubs

Only available from Cambro European Logistics (CEL), Germany and Cambro Ōzay Bulgaria.

Minimum quantity order from CEL: Stock item one case, Non-stock item 120 pieces. No broken carton.

STOCK PRODUCTS & PATTERNS AVAILABLE IN OUR EUROPEAN WAREHOUSE

MA2028, MA2435, MA3343, MA3646, MA3753: (E86), (E87), (E88), (E89), (E90)

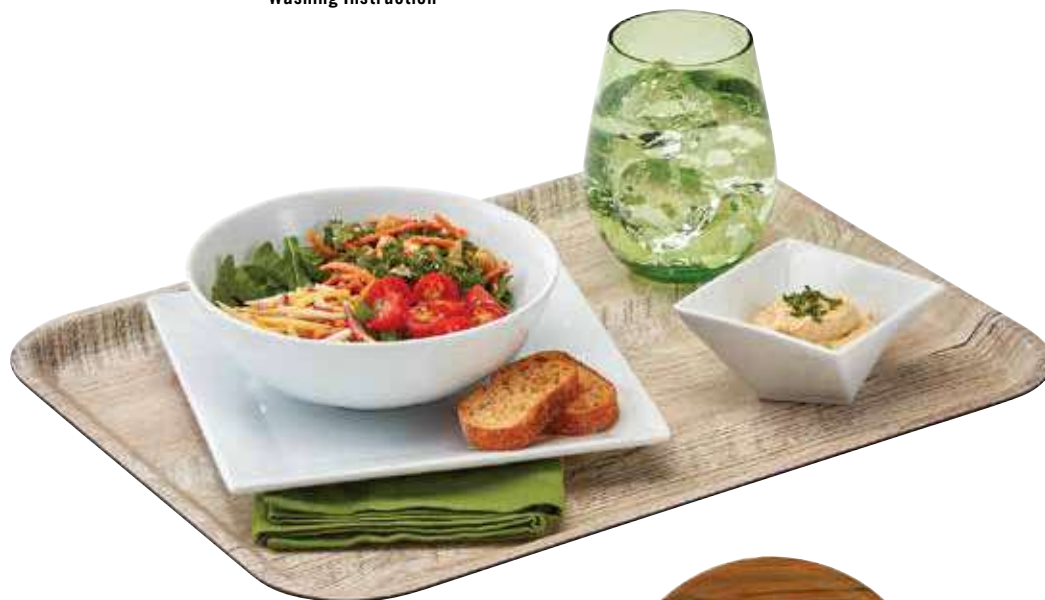

CODE	DIA / SIZE	CASE PACK
Rectangular		
MA2028	20 x 28 cm	24
MA2435	24 x 35	24
MA3343	33 x 43	24
MA3646	36 x 46	24
MA3753	37 x 53	24
MA4361	43 x 61	12
Rectangular with handle		
MA3142H	31 x 42	24
Trapezoid		
MA3652TR	36 x 52	24
Round		
MA3200	ø 32	24
MA3800	ø 38	24
MA4300	ø 43	24



Tray Colors:



E86
Light Oak



E87
Brown Oak



E88
Dark Oak



E89
Light Olive



E90
Brown Olive

FAST FOOD TRAYS

SPECIFICATIONS

Material	Polypropylene
Surface Characteristic	Textured
Performance	Good
Stacking Lugs	Yes
Dishwasher Safe	Yes-Minimal**
Chemical Resistance	Excellent
Drying Test	Good
Shock Resistance	Good
Break Resistance	Good
Scratch Resistance	Good
Stain Resistance	Good
Heat Resistance	-10° to +80°C‡



‡Not for use in heated carts.
 **Wash once per day for 60 seconds at a maximum temperature of 80°C.

RECOMMENDED USE

Moderate Traffic / Economic Priority

- Quick Serve Restaurants
- Food Courts / Snack Shops



STOCK PRODUCTS & COLORS AVAILABLE IN OUR EUROPEAN WAREHOUSES

- 1216FF: (110), (119), (163), (167), (168), (186)
 1418FF: (107), (110), (119), (163), (167), (168), (186)
 1217FFH: (110), (166), (167), (416)
 1014FF: (107), (110), (163), (167), (416)



1217FFH



1418FF



Available Colors:



CODE	SIZE	CASE PACK
Rectangular – High Profile Shape		
1014FF	26,5 x 34,5 cm	24
1216FF	30 x 41	24
1418FF	35,5 x 45,7	12
Rectangular – High Profile Shape with Handles		
1217FFH*	30 x 43	24

*Available in the following colors: Black (110), Sherwood Green (119), Orange (166), Brown (167), Cranberry (416). All Fast Food trays sizes manufactured in the United States can be personalized. All Fast Food trays sizes manufactured in Europe and China cannot be personalized.



COMPARTMENT TRAYS

SPECIFICATIONS

Code	10146CW	BCT1014	PS1014
Material	Camwear®	ABS	Co-Polymer
Surface Characteristic	Textured	Textured	Textured
Performance	Excellent	Excellent	Excellent
Stacking Lugs	Yes	Yes	Yes
Dishwasher Safe	Yes – Extensive	Yes – Extensive	Yes – Minimal
Chemical Resistance	Good	Excellent	Excellent
Drying Test	Excellent	Excellent	Excellent
Shock Resistance	Excellent	Good	Good
Break Resistance	Excellent	Good	Excellent
Scratch Resistance	Very Good	Very Good	Very Good
Stain Resistance	Very Good	Very Good	Very Good
Heat Resistance	-40° to +99°C‡	-10° to +82°C‡	-10° to +80°C‡

‡Not for use in heated carts.

RECOMMENDED USE

Moderate Traffic / Economic Priority

- School
- Universities
- Military

ABS and Co-Polymer trays are not NSF listed.



Camwear

NSF 3 PRORATED



ABS

2 PRORATED



Co-Polymer

2 PRORATED



150CW, 100CW, 50CW, 45CW, 35CW, 10CW and SRB5CW reusable bowls fit in this tray and can be used to serve cereal, soup & salads.



PS1014 on OETR314 Open End Tray Rack.



BCT1014, PS1014 & 10146CW

CODE	SIZE	CASE PACK
Camwear		
10146CW	25,4 x 36,5 cm	24
ABS - BPA FREE		
BCT1014	25,4 x 36,5	24
Co-Polymer - BPA FREE		
PS1014	25,4 x 36,5	24

COMPARTMENT TRAYS

SPECIFICATIONS

Material	Camwear®	Co-Polymer
Surface Characteristic	Textured	Textured
Performance	Excellent	Excellent
Stacking Lugs	Yes	Yes
Dishwasher Safe	Yes – Extensive	Yes – Minimal
Chemical Resistance	Good	Excellent
Drying Test	Excellent	Excellent
Shock Resistance	Excellent	Good
Break Resistance	Excellent	Excellent
Scratch Resistance	Very Good	Very Good
Stain Resistance	Very Good	Very Good
Heat Resistance	-40° to +99°C‡	-10° to +80°C‡

‡Not for use in heated carts.

RECOMMENDED USE

Moderate Traffic / Economic Priority

- School
- Universities
- Military

100CW, SRB13CW and 50CW bowls fit in round compartment. 10CW and 150CW bowls fit in square compartment. See Dinnerware and Swirl Bowl sections.

ABS and Co-Polymer trays are not NSF listed.



915CP



1596CW

Camwear

NSF 3 PRORATED

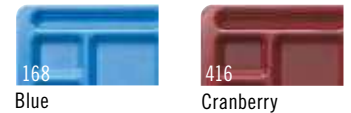
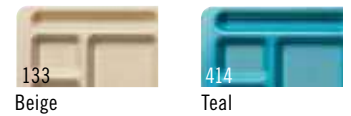

Co-Polymer

2 PRORATED

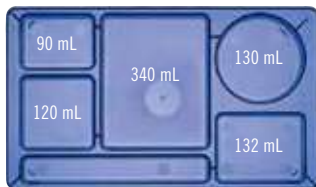
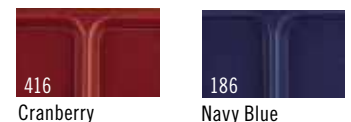

915CW & 915CP

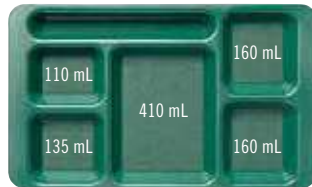

1596CW & 1596CP

CODE	SIZE	CASE PACK
Camwear		
1596CW	22,9 x 38 cm	24
915CW	22,2 x 38	24
Co-Polymer - BPA FREE		
1596CP	22,9 x 38	24
915CP	22,2 x 38	24



915CW and 1596CW inside two PR314 Camracks.

MEAL DELIVERY TRAYS



- Three deep-dish food compartments for large portions.
- Snap-on cover fits securely.
- Textured surface minimizes scratching.

Camwear Colors:
Beige (133), Teal (414).
Lid Color: Clear (135).

.....

Co-Polymer Colors:
Teal (414), Brown (167), Tan (161).
Lid Color: White (148).

.....

Co-Polymer is not NSF Listed.

.....

Not for use in heated carts.

.....



Camwear®



133

Beige



414

Teal

Co-Polymer



161

Tan

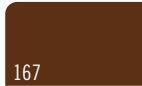

167

Brown



414

Teal



9113CW/9113CP

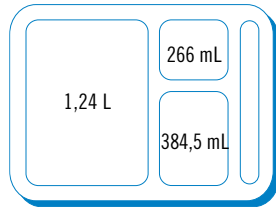

9114CW/9114CP

CODE	DESCRIPTION	DIMENSIONS W x L x D
Camwear		
9113CW	3 Compartments	22,8 x 27,9 x 6,8 cm
9114CW	4 Compartments	22,8 x 27,8 x 6,7
911CWC	Lid fits both trays	22,9 x 28 x 1,4
Co-Polymer - BPA FREE		
9113CP	3 Compartments	22,5 x 27,2 x 6,6
9114CP	4 Compartments	22,6 x 27,2 x 6,6
911CPC	Lid fits both trays	22,6 x 27,4 x 1,4

Case Pack: 24

SEPARATOR® COMPARTMENT TRAYS

- Six compartment tray designed specifically for in-cell feeding programs.
- Serve both hot and cold food from the same tray.
- Tray with cover separates each compartment to retain food temperature and reduce spills.
- Locking ridges on top of cover and bottom of tray ensure more secure stacking.

Camwear Color: Beige (133).
Lid Color: Clear (135).

.....

Co-Polymer Colors:
Teal (414), Brown (167), Tan (161).
Lid Color: Translucent (190).

.....

Co-Polymer is not NSF Listed.

.....

Not recommended for heated cart.

.....



Camwear



133

Beige

Co-Polymer

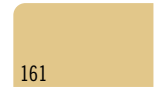

161

Tan

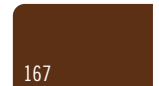

167

Brown

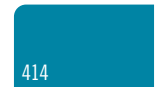

414

Teal

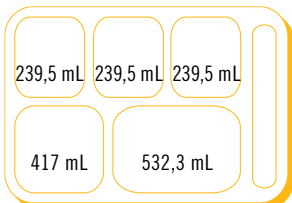

10146DCW/10146DCP

CODE	DESCRIPTION	DIMENSIONS W x L x D
Camwear		
10146DCW	6 Compartments	25,4 x 36,1 x 3,3 cm
10146DCWC	Lid fits 10146DCW	26 x 36,2 x 3,5
Co-Polymer - BPA FREE		
10146DCP	6 Compartments	25,4 x 36 x 2,9
10146DCPC	Lid fits 10146DCP	25,6 x 35,6 x 3,6

Case Pack: 24

TRAY ON TRAY MEAL DELIVERY SYSTEM

Base Tray

- Combine hot and cold food portions into a reusable, single service unit.
- Works as a tray or for in-cell feeding with the insert tray.
- Base tray has 5 compartments with 1 compartment for resting the insert tray.

Camwear Color: Beige (133).

Co-Polymer Colors: Brown (167), Tan (161).

Co-Polymer is not NSF Listed.

Not for use in heated carts.



1411CW



1411CW base tray with 853FH insert tray

Camwear®



133
Beige

Co-Polymer

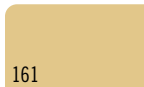

161
Tan



167
Brown

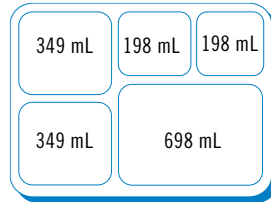

1411CW/1411CP

CODE	DESCRIPTION	DIMENSIONS W x L x D
Camwear		
1411CW	Compartments	26,8 x 36,5 x 3,3 cm
Co-Polymer - BPA FREE		
1411CP	Compartments	26,8 x 36,5 x 3,3

Case Pack: 24

Insert Tray

- Eight trays efficiently fit on a standard sheet pan or in an 45,5 x 65,5 cm wire rack.

Camwear Color: Beige (133).

Lid Color: Clear (135).

Co-Polymer Colors: Brown (167), Tan (161).

Lid Color: Translucent (190).

Heat Resistant Plastic Tray and Lid Color: Amber (150).

Co-Polymer is not NSF Listed.

Not for use in heated carts.



Camwear



133
Beige

Co-Polymer

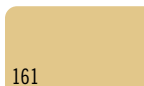

161
Tan



167
Brown

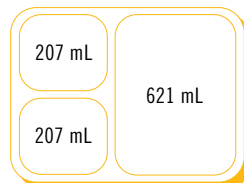

853FCW/853FCP/853FH

Heat Resistant Plastic

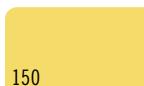

150
Amber

CODE	DESCRIPTION	DIMENSIONS W x L x D
Camwear		
853FCW	Compartments	16 x 22,1 x 4,8 cm
853FCWC	Lid for 853FCW	17,1 x 22,4 x 0,6
Co-Polymer		
853FCP	Compartments	16 x 22,1 x 4,8
853FCPC	Lid for 853FCP	17,1 x 22,4 x 0,6
Heat Resistant Plastic		
853FH	Compartments	16 x 22,1 x 4,8
853FHC	Lid for 853FH	17,1 x 22,4 x 0,6

Case Pack: 24

COMPARTMENT SERVING TRAYS

- For cafeteria-style feeding in high security environments.
- Compartment configurations designed to meet all menu requirements.
- Trapezoid Compartment Trays space saving for self serve correctional facility feeding.

Camwear 6-Compartment Colors:
Navy (186), Cranberry (416), Yellow (145),
Sherwood Green (119), Beige (133),
Black (110).

5-Compartment Color: Beige (133).
Co-Polymer Color: Tan (161).

14105CP is not NSF Listed.

Trapezoid Compartment Trays are covered
by the following U.S. Patent D 508,634.



Camwear®



Co-Polymer



NT9CP Co-Polymer Cup:
For details contact your
Cambro representative.



10146CW



10145CW

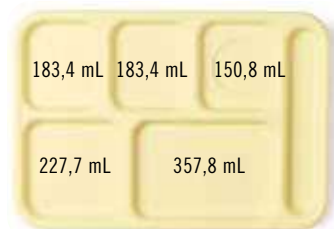

10146CW



14105CW / 14105CP

CODE	DESCRIPTION	DIMENSIONS W x L x D	CASE PACK
Camwear			
10146CW	6 compartments	25,4 x 36,8 x 2,4	24
14105CW	5 compartments	27,2 x 35,2 x 2,9	24
10145CW	5 compartments	25,4 x 36,8 x 2,4	24
Co-Polymer - BPA FREE			
14105CP	5 compartments	27,2 x 35,2 x 2,9	24

MARKET TRAYS AND PANS

SPECIFICATIONS

Material	Fiberglass layers + polyester resin
Surface Characteristic	Smooth
Performance	Excellent
Stacking Lugs	Yes
Dishwasher Safe	Yes – Extensive
Chemical Resistance	Good
Drying Test	Excellent
Shock Resistance	Excellent
Break Resistance	Good
Scratch Resistance	Good
Stain Resistance	Excellent
Heat Resistance	-10° to +100°C‡

‡Not for use in heated carts.

RECOMMENDED USE

Moderate Traffic /
Economic Priority

– Deli / Buffet Displays

Colors: Yellow (145)**, Blue (142),
Green (140), White (148), Black (110).

*Special order item not carried in stock
– non-returnable.

**NSF listed for non-direct food
contact only.

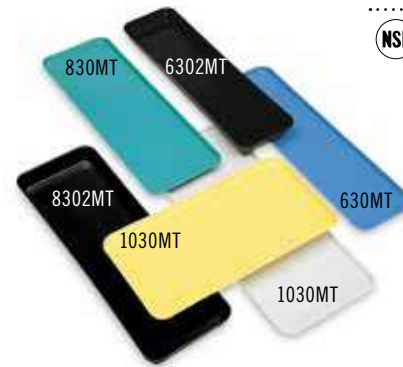

CODE	DIMENSIONS W x L x D	CASE PACK
Market Trays		
630MT*	16,4 x 76,2 x 1,9 cm	12
826MT*	21,6 x 64,1 x 1,9	12
830MT*	21,4 x 76,2 x 1,9	12
913MT*	22 x 31,6 x 2,1	12
918MT*	22 x 45,7 x 2,1	12
926MT*	22,5 x 64,9 x 2,5	12
1015MT*	25,7 x 38,1 x 1,9	24
1030MT*	26,5 x 76,2 x 1,9	12
1218MT*	29,2 x 45,1 x 2,5	12
1224MT*	31,6 x 61 x 1,9	12
1230MT*	31,6 x 76,2 x 1,9	12
1318MT*	32,1 x 45,1 x 2,7	12
1826MT*	45,2 x 65,2 x 2,7	6
2025MT*	52,7 x 64,9 x 2,1	6
Market Pans		
6302MT*	16,7 x 76,2 x 5,1	12
8262MT*	21,5 x 64,1 x 5,1	12
8302MT*	21,4 x 76,2 x 5,1	12
92615MT*	22,5 x 64,8 x 3,8	12
10302MT*	26,5 x 76,2 x 5,1	12

CAMDUCTION® COMPLETE HEAT SYSTEM – HOT MEAL DELIVERY SYSTEM

Camduction innovative hot meal delivery system is fast and efficient. Camduction is perfect for any facility with a hot tray line system. One charger can accommodate up to 300 meals per service.

Camduction Charger covered by U.S. Patent 8,263,906 B2.
Camduction Base covered by U.S. Patent D630,897 S.
.....
Camduction Charger comes with 1 year warranty.
.....

STOCK PRODUCTS & COLORS AVAILABLE IN OUR EUROPEAN WAREHOUSES

MDSCDC9X5EU24V: (000)
MDSCDB9EU24V: (487), (497)



Quickly and efficiently heats up to 20 Camduction bases at one time. Initial start-up takes approximately 4 - 6 minutes.

Supports up to 5 trays per minute, improving operational efficiency.

Holds hot foods safe at 60°C or higher for up to 60 minutes. Based on voltage supply.



Energy efficient unit turns off after 45 minutes of inactivity.

Camduction charger is made of high-grade, durable stainless steel that remains cool to the touch.

Easy to operate: amber slot LED indicates bases are heating. Green light indicates ready.

Independent functionality of each compartment reduces the risk of service interruption.

Specify cord and plug for country of usage.

Camduction Charger and Base



The Camduction Base provides reliable hot temperature retention.

CODE	MDSCDC9X5EU24V
DESCRIPTION	Camduction base charger, three phase
CAPACITY	20 Bases
OVERALL DIMENSIONS W x D x H	76,2 x 47,9 x 87,9 cm
VOLTAGE / PHASE	PE AC 380-480V, three phase
AMPS / HERTZ	16, 50/60
PLUG TYPE	Available in multiple plug types
ELECTRICAL CORD	2 m
INITIAL HEAT UP TIME	4 - 6 minutes
ALL INDICATOR LIGHTS	LED
UNIT WEIGHT	52,6 kg
CASE PACK	1

Color: Stainless Steel (000).

CODE	MDSCDB9EU24V (NSE)
DESCRIPTION	Camduction base holds 22,86 cm plate
OUTSIDE DIAMETER	24,31 cm
OUTSIDE HEIGHT	2,26 cm
FULL-SIZE CAMRACK®	PR59314
CASE PACK	12

CAMDUCTION® COMPLETE HEAT SYSTEM – HOT MEAL DELIVERY SYSTEM

- Cool rims are safe to touch.
- Bases are durable and dishwasher safe.
- Resistant to chips, cracks, and breaks.
- Bases and Domes are available in navy blue and cranberry.
- Energy Efficient Unit goes in to heat retention mode. Keeps bases hot and saves energy.

The Results of the Camduction Complete Heat System

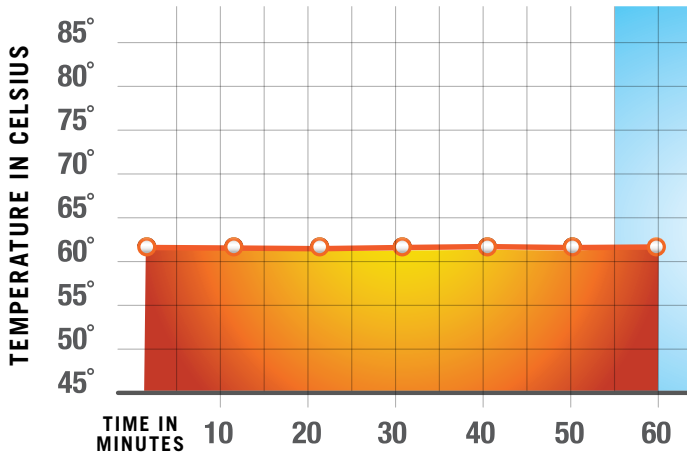

Results based on heated plate between 90°-100°C and hot food at approximately 85°C.

NOTE: Operator results may vary based on menu items and starting temperatures.

The Camduction Base System

A heated Camduction Base, combined with a properly heated 22,8 cm Cambro Ceramic Plate, covered with a Cambro Shoreline Insulated Dome will hold hot food at safe temperatures 65°C or higher for up to 60 minutes.



2 2 year pro-rated warranty on Bases.



487
Cranberry



497
Navy Blue



Safe to the touch even when fully charged.

TEMPERATURE RETENTION SYSTEMS

Cambro offers an array of products that support a variety of temperature retention systems. As each facility has its own separate needs and challenges, different serving solutions are needed.

MDSADB9, HK39B, MDSAD9 and MDSL9
Colors: Meadow (447), Wheat (457), Speckled Gray (480), Cranberry (487), Navy Blue (497), Black (110), Smoked Metal (485)*.

MDSAD9 Color: Black (110).

MDSAD9 Color: Dark Gray (477).

MDSAD9 Color: (000).

*Only available for Harbor Dome and Camduction Base.

MDSAD9 not NSF listed.

MDSADB9 is covered by U.S. Patent D 630, 8975 S and 8,263,906 B2.



STOCK PRODUCTS & COLORS AVAILABLE IN OUR EUROPEAN WAREHOUSES

MDSADB9EU24V: (487), (497)

Camduction®



- A. Insulated Dome
- B. 22,86 cm Ceramic Plate
- C. Camduction Base

Insulated Base



- A. Insulated Dome
- B. 22,86 cm Ceramic Plate
- C. Heat Keeper Insulated Base

Thermal Pellet



- A. Insulated Dome
- B. 22,86 cm Ceramic Plate
- C. Hot Thermal Pellet
- D. Underliner

Cold Pellet

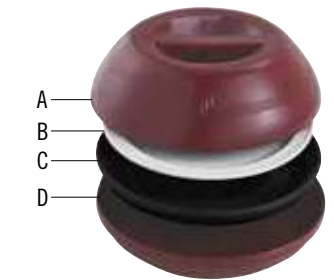

- A. Insulated Dome
- B. 22,86 cm Ceramic Plate
- C. Cold Pellet
- D. Underliner

Camduction Complete Heat System

The most efficient heat retention solution, holds hot food at safe temperatures 65°C or higher for up to 60 minutes.

- Camduction Bases are durable and dishwasher safe.
- Resistant to chips, cracks and breaks.
- Revolutionary technology eliminates errors or issues with spikes in voltage.



MDSADB9EU24V

Camduction base holds 22,86 cm plate

OUTSIDE DIAMETER: 24,31 cm

OUTSIDE HEIGHT: 2,26 cm

FULL-SIZE CAMRACK®: PR59314

Case Pack: 12

Heat Keeper Insulating Base System

The cost-effective solution for heat retention, holds temperature for 20 minutes or more.

- Resists stains, odors and scratches.



HK39B

Insulating base holds 22,86 cm plate

OUTSIDE DIAMETER: 24,48 cm

OUTSIDE HEIGHT: 4,07 cm

FULL-SIZE CAMRACK: PR59314

Case Pack: 12

MEAL DELIVERY WARE SYSTEM – THE HARBOR COLLECTION

- Attractive design provides a pleasant dining experience.
- Supports temperature maintenance.
- Available in six popular colors to complement any decor.
- Mugs and bowls fit existing line of Cambro disposable CamLids® for Shoreline Collection.
- Made of polypropylene, won't chip or break.
- High temperature dishwasher safe.
- Dome fits 22,86 cm plate.
- Works with all Cambro Temperature Retention Systems, Camduction® Complete Heat System, Camtherm® Thermal Pellet System, Heat Keeper Insulating Base System and Camchiller® Pellet System.

Cambro insulated ware is not recommended for use in a microwave oven as this will increase the likelihood of staining and cracking, neither of which is covered under the manufacturers warranty.

Insulated Harbor bowl is covered by U.S. Patent D795,017 S.



CODE	MDSHD9	MDSHB5	MDSHB9	MDSHM8
DESCRIPTION	Insulated dome covers 22,86 cm plate	Insulated small bowl	Insulated large bowl	Insulated mug
LID CODE	—	CLSM8B5, CLRSM8B5	CLSB9, CLRSB9	CLSSM8B5, CLSM8B5, CLRSM8B5
APPROX. CAPACITY	—	150 mL	270 mL	240 mL
OUTSIDE DIAMETER	25,94 cm	8,89 cm	11,11 cm	11,43 cm
HEIGHT	8,17 cm	6,1 cm	6,1 cm	10,16 cm
FULL-SIZE CAMRACK®	PR59314	16C414	9S318	16C414
CASE PACK	12	48	48	48

Harbor Meal Delivery Ware Colors:



TEMPERATURE RETENTION SYSTEMS

Camtherm® Thermal Pellet System

The perfect choice for maximum heat retention, holds temperature for 60 minutes or more.

- Holds heat at its core to keep hot foods at safe temperatures.
- Stays 11°C cooler on the edge than metal pellets to protect staff and patients from burns.
- Is a high-density plastic material that won't dent like metal pellets.



MDSPL
Thermal pellet holds 22,86 cm plate
OUTSIDE DIAMETER: 24 cm
OUTSIDE HEIGHT: 4,45 cm
FULL-SIZE CAMRACK®: PR59314
Case Pack: 12



MDSL9
Pellet underliner holds 24,13 cm pellet
OUTSIDE DIAMETER: 24,29 cm
OUTSIDE HEIGHT: 4,6 cm
FULL-SIZE CAMRACK®: PR59314
Case Pack: 12



MDSPL
Camtherm thermal pellet lifter
OUTSIDE DIAMETER: 8 cm
OUTSIDE HEIGHT: 7,6 cm
Case Pack: 1

Camchiller® Pellet System

Keeps cold food below or at 4°C for up to 45 minutes when used with a chilled plate and insulated dome.

- Shatter-resistant at freezing temperature.
- Stackable for easy transport and storage.
- Can be used with or without an underliner.
- High-temperature dishwasher safe.



MDSPC9
Camchiller pellet holds 22,86 cm plate
OUTSIDE DIAMETER: 24,31 cm
OUTSIDE HEIGHT: 3,42 cm
FULL-SIZE CAMRACK®: PR59314
Case Pack: 12



MDSL9
Pellet underliner holds 24,13 cm pellet
OUTSIDE DIAMETER: 24,29 cm
OUTSIDE HEIGHT: 4,6 cm
FULL-SIZE CAMRACK®: PR59314
Case Pack: 12

STOCK PRODUCTS & COLORS AVAILABLE IN OUR EUROPEAN WAREHOUSE

MDSPL9: (477)
MDSL9: (487), (497)

Domes, Plate Cover and Plate for all Cambro Temperature Retention Systems

STOCK PRODUCTS & COLORS AVAILABLE IN OUR EUROPEAN WAREHOUSE

MDS9, MDSL9: (487), (497)
MDSPL9: (148)



CODE	MDS9	MDSL9	MDSHD9	909CW	MDSPLT9
DESCRIPTION	Insulated dome covers 22,86 cm plate	Low profile insulated dome covers 22,86 cm plate	Insulated dome cover for 22,86 cm plate	Camwear Camcover	Ceramic plate
OUTSIDE DIAMETER	25,94 cm	25,94 cm	25,94 cm	26,2 cm	22,86 cm
OUTSIDE HEIGHT	8,17 cm	6,99 cm	8,17 cm	6,99 cm	2,54 cm
FULL-SIZE CAMRACK	PR59314	PR59314	PR59314	PR59314	PR314
CASE PACK	12	12	12	12	24

MDS9, MDSL9 and MDSHD9 Colors: Meadow (447), Wheat (457), Speckled Gray (480), Cranberry (487), Navy Blue (497), Black (110), Smoked Metal (485)*.
909CW Colors: Clear (152), Amber (153), Beige (133), Silver (486). **MDSPLT9 Color:** White (148). *Smoked Meal (485) only available for Harbor Dome.
 MDSPLT9 Sold in full cases only.



REUSABLE CAMLIDS® FOR MEAL DELIVERY SYSTEMS

- Save up to 75% in lid costs each year.
- Reduce your waste-stream significantly each year when you switch from disposables to reusables.
- Dishwasher safe.
- Made of durable polypropylene.
- Fits both Shoreline and Harbor Collection mugs and bowls.
- Contact your Cambro Sales Representative for a Customized Savings Calculator!

Reusable CamLid Color: White (148).

Camrack Wash and Store Rack Color: Kelly Green (452).

Camrack Base Full Size Color: Soft Grey (151).

Full Rack Cover Color: Grey (180).

CLRWSR36 is covered under U.S. patent D 617,069.

Full Rack Cover not NSF certified.



STOCK PRODUCTS & COLORS AVAILABLE IN OUR EUROPEAN WAREHOUSE

CLRSB9: (490)
 CLRWSR36: (452)
 BR578: (110), (163), (167), (168), (184), (186), (414), (416), (119), (151)
 DRC2020: (180)
 E3: (151)
 CRPHDG2878: (000)

Visit www.cambro.com/savemoney for a Customized Savings Calculator!



Camrack® Wash and Store Rack

- Designed for safe and secure washing and storing of Reusable CamLids, CLRSB9 and CLRSM8B5 only.
- Each Camrack Wash and Store Rack holds 36 Reusable CamLids.
- 2 Wash and store Racks fit in a Full Size Base Rack.



CODE	DESCRIPTION	DIMENSIONS	CASE PACK
Reusable CamLids		H x Dia.	
CLRSM8B5	Fits 240 mL mug and 150 mL bowl	0,71 x 9,05 cm	240
CLRSB9	Fits 270 mL bowl	0,71 x 11,32	240
CLRSB16	Fits 500 mL bowl	0,71 x 13,97	240
Accessories for CLRSM8B5 and CLRSB9		L x W x H	
CLRWSR36	Camrack wash and store rack to wash 36 reusable lids	20,96 x 45,4 x 13,97	4
BR578	Camrack full size base rack with 2 extenders	50 x 50 x 18,4	4
DRC2020	Full rack cover	50 x 50 x 2,4	1
Accessories for CLRSB16		L x W x H	
PR500	9 x 9 peg rack with 1 extender	50,17 x 50,17 x 14,29	5
E3	Full size open extender	50,17 x 50,17 x 2	12
CRPHDG2878	Full size square hold down grid	46,67 x 46,67	6

Reusable CamLids sold in cases only. No broken cartons.

CAMSHELVING® HYGIENIC DRYING RACKS



- Keep tray line and warewashing areas organized and prevent wet stacking by storing newly washed products upright for faster drying before storing.
- Non-corrosive, break resistant and easy to assemble.
- Mobile racks allow for easy floor clean up and maneuverability.
- Drying cradles are removable and are high temperature dishwasher safe.
- Combine individual drying cradles to build custom drying racks on 600 mm deep Camshelving units.
- Lifetime warranty against rust and corrosion on posts and traverses.
- Drying Cradles are made of high impact ABS material.

*Camshelving Premium Series Color: Speckled White (490).

**Drying Cradle Color: Soft Gray (151).

Casters:

4 Premium Casters: (2 swivel with total locking brake, 2 swivel with no brake).



Vertical Drying and Storage Rack

- Securely holds various sizes of trays, cutting boards, baking sheet pans, lids and plates 20,5 to 34,3 cm.
- Drying Cradles are installed directly onto shelf traverses.
- Fits 600 mm shelves.

7-Slot Drying Cradle is covered by U.S. Patent D 663,912 S.



STOCK PRODUCTS & COLORS AVAILABLE IN OUR EUROPEAN WAREHOUSE

CSDR7, CSDR73: (151)
MPMU61117DRPKG, MPMU61317DRPKG: (490)



CSDR7
7-Slot Drying Cradle
Width Per Slot: 3,3 cm

CODE	DESCRIPTION	DIMENSIONS D x L x H	HOLDING CAPACITY	CASE PACK
Camshelving Premium*				
MPMU61117DRPKG	Vertical drying rack	600 x 1180 x 1790 mm	84 Trays	1
MPMU61317DRPKG	Vertical drying rack	600 x 1380 x 1790	105	1
Drying Cradles**				
CSDR7	7-Slot drying cradle	597 x 260 x 95	—	1
CSDR73	7-Slot drying cradle	597 x 260 x 95	—	3

Drying Cradles fit on Camshelving Premium Series, mobile or stationary 600 mm deep shelves.

Package Includes: Pre-assembled mobile post kits, 6 traverses for each model, 12 or 15 drying cradles and premium swivel casters with total locking brake. Assembly required.



MPMU61117DRPKG
Camshelving Premium

CAMSHELVING® HYGIENIC DRYING RACKS



Angled Drying and Storage Rack

- Securely holds up to 128 meal delivery Pellets/Bases or a variety of food pan sizes, pots and kitchen wares.
- Drying Cradles are installed directly onto shelf traverses.
- Fits 600 mm shelves.

*Camshelving Premium Series Color: Speckled White (490).
 **Drying Cradle Color: Soft Gray (151).

8-Slot Drying Cradle is covered by U.S. Patent D739,989 S.



STOCK PRODUCTS & COLORS AVAILABLE IN OUR EUROPEAN WAREHOUSE

CSDR8, CSDR84: (151)
 MPMU61217PDPKG: (490)

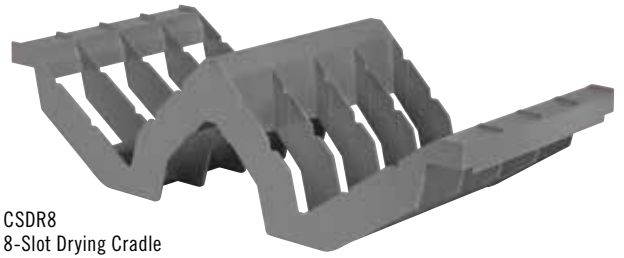

CSDR8
 8-Slot Drying Cradle
 Width Per Slot: 6 cm

CODE	DESCRIPTION	DIMENSIONS D x L x H	HOLDING CAPACITY	CASE PACK
Camshelving Premium*				
MPMU61217PDPKG	Angled drying rack	600 x 1280 x 1790 mm	128 pellets and bases or 16 GN 1/1 food pans	1
Drying Cradles**				
CSDR8	8-Slot drying cradle	592 x 263 x 160	—	1
CSDR84	8-Slot drying cradle	592 x 263 x 160	—	4

Individual Drying Cradles fit on Camshelving Premium Series 600 mm deep shelves only, mobile or stationary.
Package Includes: Units ship complete with 2 mobile post kits, 8 traverses, 16 angled drying cradles and premium swivel casters with total locking brake. Assembly required.



MPMU61217PDPKG
 Camshelving Premium

Dome Drying and Storage Rack

- Securely holds 100 meal delivery domes.
- Drying Cradles are installed directly onto shelf traverses.
- Fits 600 mm shelves.

*Camshelving Premium Series Color: Speckled White (490).
 **Drying Cradle Color: Soft Gray (151).

10-Slot Drying Cradle is covered by U.S. Patent D 736,488 S.



STOCK PRODUCTS & COLORS AVAILABLE IN OUR EUROPEAN WAREHOUSE

CSDDC24, CSDDC245: (151)
 MPMU6917DDPKG: (490)



CSDDC24
 10-Slot Drying Cradle
 Width Per Slot: 7,8 cm

CODE	DESCRIPTION	DIMENSIONS D x L x H	HOLDING CAPACITY	CASE PACK
Camshelving Premium*				
MPMU6917DDPKG	Dome drying rack	600 x 980 x 1790 mm	100 Domes	1
Drying Cradles**				
CSDDC24	10-Slot drying cradle	597 x 415 x 86	—	1
CSDDC245	10-Slot drying cradle	597 x 415 x 86	—	5

Individual Drying Cradles fit on Camshelving Premium Series 600 mm deep shelves only, mobile or stationary.
Package Includes: Pre-assembled mobile post kits, 10 traverses, 10 drying cradles and premium swivel casters with total locking brake. Assembly required.



MPMU6917DDPKG
 Camshelving Premium

TABLOTERM CAM GOBOX® MEAL DELIVERY SYSTEM

The Tablotherm Cam GoBox is the cost-effective solution for delivering single-served meals. This lightweight insulated tray separates hot and cold foods, keeping meals at safe temperatures for up to 60 minutes. Extra compartments can be used for beverages and snacks for a convenient and complete meal delivery.

Lids 122701118, 122700021 and 122700023 are BPA Free.



Excellent insulation and temperature retention.

Made of expanded polypropylene.

Maintains hot and cold foods safe in one unit for up to 60 minutes.

Stackable, lightweight individual meal delivery system for easy transportation and storage.

TABLOTHERM CAM GOBOX® MEAL DELIVERY SYSTEM



ITENEPP
EPP Tablotherm without dishes
EXTERIOR DIM. L x W x H:
37 x 53 x 11,8 cm
UNIT WEIGHT: 0,55 kg
Case Pack: 1 **Color:** Grey (107).



ITENEPP118
EPP Tablotherm with dishes -
2 rectangular dishes 11 x 18 cm,
2 bowls 14 cm, reusable covers
EXTERIOR DIM. L x W x H:
37 x 53 x 11,8 cm
UNIT WEIGHT: 2,53 kg
Case Pack: 1 **Color:** Grey (107).



ITENEPP21
EPP Tablotherm with dishes -
1 plate 21 cm, 2 bowls 14 cm,
reusable covers
EXTERIOR DIM. L x W x H:
37 x 53 x 11,8 cm
UNIT WEIGHT: 2,27 kg
Case Pack: 1 **Color:** Grey (107).



ITENEPP23
EPP Tablotherm with dishes -
1 two-compartment plate 23 cm,
2 bowls 14 cm, reusable covers
EXTERIOR DIM. L x W x H:
37 x 53 x 11,8 cm
UNIT WEIGHT: 2,32 kg
Case Pack: 1 **Color:** Grey (107).



ITENEPP118H
EPP Tablotherm with dishes - 2
rectangular dishes 11 x 18 cm, 2
Shoreline bowls MDSB16 (13,6 cm)
(500 mL), 2 reusable covers CLRSB16
EXTERIOR DIM. L x W x H:
37 x 53 x 11,8 cm
UNIT WEIGHT: 1,82 kg
Case Pack: 1 **Color:** Grey (107).



ITENEPP21H
EPP Tablotherm with dishes - 1 plate
21 cm, 2 Shoreline bowls MDSB16
(13,6 cm) (500 mL), 2 reusable
covers CLRSB16
EXTERIOR DIM. L x W x H:
37 x 53 x 11,8 cm
UNIT WEIGHT: 1,57 kg
Case Pack: 1 **Color:** Grey (107).



ITENEPP23H
EPP Tablotherm with dishes - 1
two-compartment plate 23 cm, 2
Shoreline bowls MDSB16 (13,6 cm)
(500 mL), 2 reusable covers CLRSB16
EXTERIOR DIM. L x W x H:
37 x 53 x 11,8 cm
UNIT WEIGHT: 1,62 kg
Case Pack: 1 **Color:** Grey (107).

STOCK PRODUCTS & COLORS AVAILABLE IN OUR EUROPEAN WAREHOUSE

All TABLOTHERM CAM GOBOXES: (107)
122401118, 122601118, 122400021,
122600021, 122400023, 122600023,
122500014, 122700014: (000)
MDSB16: (480)

Ceramicware



CODE	122401118	122701118	122400021	122700021	122400023	122700023	122500014	122700014	MDSB16
DESCRIPTION	Porcelain rectangular dish	Rectangular dish cover for 122400018	Porcelain plate	Plate cover for 122400021	2-compartment porcelain plate	Plate cover for 122400023	Porcelain bowl 14 cm	Bowl cover	Insulated Shoreline bowl - 500 mL
EXTERIOR DIM. (CM)	11 x 18	11 x 18	Ø 21	Ø 21,5	Ø 23	Ø 23,5	Ø 14 x 0,7	Ø 14,5	Ø 13,6 x 6
UNIT WEIGHT (KG)	0,45	0,06	0,58	0,18	0,6	0,2	0,44	0,04	0,13
Case Pack:	1 Color: (000).								

TABLOTERM MEAL DELIVERY SYSTEM

The ideal single-serve meal delivery system for in-home service

- Transport and serve hot and cold food in one complete unit.
- Maintain safe food temperatures for over 1 hour.*
- Lightweight design makes transportation easy and convenient.
- Two sizes accommodate a variety of meal options.
- Dishwasher safe.



Tablotherms stack for easy transportation and storage.

Molded-in dimples secure the sealed lids on dishware to prevent spills and enhances temperature retention.



Break-resistant china dishware.

Compact design makes transport easy.

Safely hold hot and cold meals in one unit.



Meal set-up is convenient with Tablotherm trays and dishes.

ITPD3253 model with Heated Pellet

85°C 80°C 77°C 74°C 71°C

ITPD3253 model without Heated Pellet

85°C 72°C 68°C 64°C —

ITPD3753T model with Heated Pellet

89°C 75°C 70°C 65°C 62°C

ITPD3753T model without Heated Pellet

87°C 67°C 60°C —



*With heated pellet. Not for use in heated carts.

TABLOTERM INSULATED TRAYS

Minimum Food & Plate
Temperature before Plating: 85° - 90°C



Only available from Cambro
European Logistics (CEL), Germany.

STOCK PRODUCTS & COLORS AVAILABLE IN OUR EUROPEAN WAREHOUSE

IT3253, IT3753T, ITPD3253, ITPD3753T,
ITPD3753TH, 112 430 000, 122 400 050,
122 450 050, 122 500 050, 122 600 050,
122 650 050, 122 700 050, 122 201 050,
122 200 050, 122 260 050: (000)
MDSB16, MDSB9: (480)
CLRSB9T, CLRSB16T: (490)
165PW: (A42)



ITPD3753T - Euronorm size



Light gray polypropylene lid with integrated rubber seal. Lids cannot be used in microwave oven.

CODE	DESCRIPTION	DIMENSIONS W x L x H
Tablotherm – Insulated Tray with Porcelain Dishes, seal covers and pellet		
ITPD3753T	Euronorm insulated tray including: 1 ea. two-compartment plate (122 400 050), 1 ea. reusable cover (122 600 050), 1 ea. Pellet (165PW), 3 ea. multi-purpose bowls: 2 ea. 400 mL (122 500 050), 1 ea. 500 mL (122 450 050) and 3 ea. reusable covers: 2 ea. (122 700 050) and 1 ea. (122 650 050)	37 x 53 x 10,5 cm
Tablotherm – Insulated Tray without porcelain dishes, seal covers and pellet		
IT3753T	Euronorm insulated tray – empty	37 x 53 x 10,5
Porcelain dishes		
122 400 050	Two compartment plate. Outside ø 254 mm capacity 750 mL (white)	—
122 450 050	Multi-purpose bowl. Outside ø 142,2 mm capacity 500 mL (white)	—
122 500 050	Multi-purpose bowl. Outside ø 120 mm capacity 400 mL (white)	—
Reusable polypropylene covers, light gray with integrated rubber seal		
122 600 050	For two compartment plate	—
122 650 050	For multi-purpose bowl – 500 mL	—
122 700 050	For multi-purpose bowl – 400 mL	—
Pellet System		
165PW	SMC pellet ø 16,5 cm	—
Menu card		
112 430 000	Yellow menu cards 100 x 70 mm	—
Latches		
122 201 050	Latches with menu card holder (IT3753T, ITPD3753T)	—
122 200 050	Latches without menu card holder (IT3753T, ITPD3753T)	—
122 260 050	Latches and screw kit: 1 ea. latch, 4 ea. screws (IT3753T, ITPD3753T)	—
Tablotherm with Insulated Dishware		
ITPD3753TH	1 ea. two-compartment plate (122 400 050), 1 ea. reusable cover (122 600 050), 1 ea. Pellet (165PW), 3 ea. multi-purpose bowls: 2 ea. 270 mL (MDSB9), 1 ea. 500 mL (MDSB16) and 3 ea. reusable covers: 2 ea. (CLRSB9T) and 1 ea. (CLRSB16T)	37 x 53 x 10,5
Insulated Dishware for ITPD3753TH		
MDSB9	Insulated large bowl. Outside ø 111,1 mm – 270 mL	—
MDSB16	Insulated entree bowl. Outside ø 136,5 mm – 500 mL	—
CLRSB9T	Reusable CamLid® – 270 mL	—
CLRSB16T	Reusable CamLid – 500 mL	—

ITPD3753T, IT3753T, ITPD3753TH Color: Gray and Blue. ITPD3253, IT3253 Color: Two Tone Gray. 165PW Color: (A42).
MDSB16, MDSB9 Color: Speckled Gray (480). CLRSB16T, CLRSB9T Color: Speckled White (490). 165PW Case Pack: 1 Each.
For a complete guide to maximizing heat retention, contact your Cambro representative.

ANTIMICROBIAL CAMGUARD® VERSA TRAYS

- High performance polyester tray for ultra-intensive use.
- Built-in antibacterial protection eliminates bacteria between tray washings and will not wash off or wear away for the life of the tray.
- Reinforced polyester corners provide superior corner and edge protection against impact.
- Stacking lugs allow air circulation for fast drying and perfect stacking.
- Temperature range resistance from -40° to 140°C. ‡
- Dishwasher safe – Wash as often and as frequently as needed.

‡ Not for use in heated carts.



Minimum quantity order from CEL:
Non-stock item 240 pieces.
No broken carton.

**Only available from Cambro
European Logistics (CEL), Germany.**

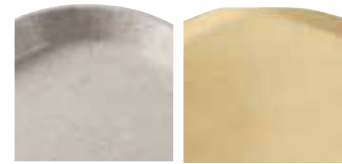

High Profile Shape Low Profile Design Shape



Flat Edge Shape



camguard

ANTIMICROBIAL TRAYS

Trays have built-in antimicrobial properties to protect against mildew growth and bacterial odors. This protection will not wash or wear off.

Unprotected Surface versus Camguard Protected Surface 24 Hour Test.



Unprotected

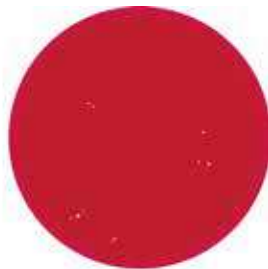

Protected with Camguard

CODE

DIMENSIONS

Versa Trays – High Profile Shape

VT1418AB	35,5 x 45,7 cm
VT3343AB	33 x 43

Versa Century™ Trays – Low Profile Design Shape

VT3646CAB	35,5 x 45,7
VT3343CAB	32,9 x 42,9

Versa Trays – Flat Edge Shape

GP1070AB*	26,5 x 32,5
GP1080AB*	26,5 x 37
GP3980AB*	37 x 53
GP4002AB*	32,5 x 53

Case Pack: 12

*Designed with reinforced corners for automatic off-stacking onto conveyor belt dishwashers.



Innovative low profile and low corner design increases space utilization of tray surface and customer comfort while eating.



Reinforced polyester corners provide superior corner and edge protection against impact.



Stacking lugs keep trays stacked securely in place and ensure proper air flow.

Tray Color:



A83

Granite

POLYESTER DECORATED VERSA TRAYS WITH SMOOTH OR NON-SLIP SURFACE

- Reduce waste, save money and provide a stable tray surface for meal delivery.
- Switching from paper tray mats will generate annual savings of over 50%.
- Your Green Initiatives will get rapid results with the elimination of up to 10 tons of trash each year.
- High performance polyester tray for ultra-intensive use.
- Reinforced polyester corners provide superior corner and edge protection against impact.
- Stacking lugs allow air circulation for fast drying and perfect stacking.
- Dishwasher safe – Wash as often and as frequently as needed.

‡ Not for use in heated carts.

*Designed with reinforced corners for automatic off-stacking onto conveyor belt dishwashers.

If you are using Thermo-Chemical Disinfection Equipment, please contact us. We will assist you finding the right tray for your application

Personalization: Contact your Cambro representative for pricing.



Flat Edge Shape

Only available from Cambro European Logistics (CEL), Germany.

Minimum quantity order from CEL:
Stock item one case, Non-stock item 120 pieces. No broken carton.



Non-Slip Trays grip firmly providing safer meal delivery service.



CODE	SIZE	CASE PACK
Smooth surface – Flat Edge Shape		
GP0540*	46 x 34,4 cm	12
GP3980*	53 x 37	12
GP4002*	53 x 32,5	12
GP4004	53 x 32,5	12

Temperature range resistance from -40° to 90°C.‡



PRORATED

CODE	SIZE	CASE PACK
Non-slip surface – Flat Edge Shape		
GP3980NS*	53 x 37 cm	12
GP4002NS*	53 x 32,5	12
GP0540NS*	46 x 34,4	12
GP1080NS*	37 x 26,5	12

Only available in colors: B22, B93, B99, B100.
Temperature range resistance from -40° to 80°C.‡



PRORATED

Patterns and Tray Base Colors:



B101
Brushed Steel on
Light Grey Tray

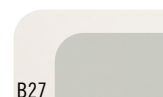

B27
Light Grey on
Light Grey Tray

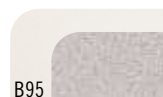

B95
Pebbled White on
Light Grey Tray



B93
Titan on
Granite Tray



B100
Pebbled Black on
Terrazzo Tray



B22
Sahara on
Sahara Tray



B99
Pebbled Black on
Light Grey Tray



B96
Pebbled White on
Terrazzo Tray

POLYESTER NON-SLIP VERSA LITE TRAYS

- Non-Slip surface provides a better grip for safer meal delivery.
- Reduce your environmental waste-stream each year when you switch from paper tray mats to Non-Slip Versa Lite Trays.
- Standard performance polyester tray for intensive use.
- Reinforced polyester corners provide superior corner and edge protection against impact.
- Stacking lugs allow air circulation for fast drying and perfect stacking.
- Temperature range resistance from -40° to 80°C. ‡
- Dishwasher safe – Wash up to 3 times per day.

Colors: Sahara on Sahara Tray (B22), Titan on Speckled Smoke Tray (B14), Sahara on Pearl White Tray (B11), Pebbled Black on Light Grey Tray (B99).

Personalization: Contact your Cambro representative for pricing.

‡ Not for use in heated carts.



STOCK PRODUCTS & COLORS AVAILABLE IN OUR EUROPEAN WAREHOUSE

GL4002NS: (B22)

Minimum quantity order from CEL: Stock item one case, Non-stock item 120 pieces. No broken carton.

Only available from Cambro European Logistics (CEL), Germany.



High Profile Shape



Low Profile Design Shape



Flat Edge Shape



Versa Lite Century Trays have low edges and ergonomic corners that enhance comfort.



Stacking lugs keep trays stacked securely in place and ensure proper air flow.



Reinforced polyester corners provide superior corner and edge protection against impact.

CODE	DIMENSIONS
Versa Lite Trays – High Profile Shape	
VL1418NS	35,5 x 45,7 cm
VL3343NS	33 x 43
Versa Lite Century™ Trays – Low Profile Design Shape	
VL3646CNS	35,5 x 45,7
VL3343CNS	33 x 43
Versa Lite Trays – Flat Edge Shape	
GL3980NS*	37 x 53
GL4002NS*	32,5 x 53

Case Pack: 12

*Designed with reinforced corners for automatic off-stacking onto conveyor belt dishwashers.

Tray Colors:

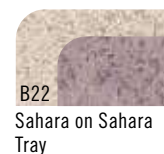

B22 Sahara on Sahara Tray



B99 Pebbled Black on Light Grey Tray



Non-Slip Trays grip firmly providing safer meal delivery service.

NON-SLIP VERSA CAMTRAYS®

- Non-Slip Trays reduce waste, save money and provide a stable tray surface for meal delivery.
- Switching from paper tray mats will generate annual savings of over 50%.
- Green Initiatives will get rapid results with the elimination of tons of trash each year.
- Non-Slip Camtrays provide a better grip for safer meal delivery.
- Dishwasher safe in low and high temperatures.
- Stacking lugs keep trays in place and ensure proper airflow between trays.
- Temperature range resistance from -40° to 80°C.‡

Camtray and Dietary Tray Colors:
Black with Pebbled Black (382),
Pearl Gray with Titan (381),
Ivory with Sahara (380).

Personalization: Contact your Cambro representative for pricing.

‡ Not recommended for heated carts.

NSF Listed for non-direct food contact only.



Non-Slip trays grip table top items firmly.

CODE	DESCRIPTION	DIMENSIONS
1418VC	Non-Slip Versa Camtray	35,5 x 45,7 cm
1520VC	Non-Slip Versa Camtray	38 x 51

Case Pack: 12

NON-SLIP VERSA CAMTRAYS FOR ROOM SERVICE

- Ergonomic handles allow for safe and elegant meal delivery.
- Trays fit within existing meal delivery carts that accommodate 35,5 x 45,7 or 38 x 51 cm trays.
- Non-Slip surface eliminates the need for tray mats saving time and money.
- Dishwasher safe at high and low temperatures.
- Stacking lugs allow for quick drying.
- Temperature range resistance from -40° to 80°C.‡
- 38 x 51 cm tray is ideal for room service.

Room Service Tray Colors:
Black with Pebbled Black (382),
Pearl Gray with Titan (381),
Ivory with Sahara (380).

Personalization: Contact your Cambro representative for pricing.

‡ Not recommended for heated carts.

Non-Slip Versa Camtrays for Room Service is covered by U.S. Patent D 683,191 S.

NSF Listed for non-direct food contact only.



High Profile Shape Flat Edge Shape



Black with Pebbled Black (382)

Pearl Gray with Titan (381)

Ivory with Sahara (380)

CODE	DESCRIPTION	DIMENSIONS
1418VCH	Non-Slip Versa Camtray with handles	35,5 x 45,7 cm
1520VCRST	Non-Slip Versa Camtray with handles	38 x 51

Case Pack: 12



CAMWEAR® NON-SLIP TRAY

- Ideal for healthcare patient meal delivery and in high-traffic cafeterias.
- Scratch-resistant, made of durable Camwear.
- Non-Slip eliminates the need for tray mats, saving time and money.
- Enhances stability, providing safer transport and service.
- Stacking lugs keep trays in place and ensure proper airflow between trays.
- Commercial dishwasher safe at high and low temperatures.
- Trays with handles are also available without non-slip surface.

Colors: Black (110), Dark Cranberry (488), Smoked Metal (485).

*Not recommended for use in heated carts.

NSF Listed for non-direct food contact only.



1520CWNS

Black (110)

Dark Cranberry (488)

Smoked Metal (485)



CODE	DESCRIPTION	DIMENSIONS
Non-Slip Surface		
1418CWNS	Camwear non-slip tray	35,5 x 45,7 cm
1520CWNS	Camwear non-slip tray	38 x 51
1418CWNSH*	Camwear non-slip tray with handles	35,5 x 45,7
1520CWNSH*	Camwear non-slip tray with handles	38 x 51
Smooth Surface		
1520CWH	Camwear tray with Handles	38 x 51

Case Pack: 12



1520CWNSH

CAMTRAYS® WITH HANDLES

- Enhance your tray presentation with these easy-to-grip, ergonomic, contoured handles.
- Stain, Scratch and odor resistant.
- Made of durable lightweight and high-impact fiberglass.
- Stacking lugs keep trays in place and ensure proper airflow between trays.
- Dishwasher safe at high and low temperatures.

Available in Group I colors.

Special order item not carried in stock, non-returnable. One case order minimum.

NSF listed for non-direct food contact only.

Personalization through digital printing process only. Please refer to Camtray Personalization section for details.



1520H

CODE	DESCRIPTION	DIMENSIONS
1418H	Camtray with handles	35,5 x 45,7 cm
1520H	Camtray with handles	38 x 51

Case Pack: 12

MEAL DELIVERY CARTS FOR TRAY SERVICE



Transport meal trays from the kitchen to acute care patients, long-term acute care patients, nursing home residents, or correctional facility inmates during in-room service.

Enhance patient satisfaction with high-quality room service-style meals served quietly and efficiently.



- Ergonomic molded-in handle design provides comfort maneuvering.
- Molded-in rails ensure quiet meal delivery while bottom bumper protects the cart, walls, and furniture during transport.
- Features secure doors with a magnetic latch to hold door in place during service. Doors swing to 270 degrees. MDC1520T20 doors swing to 190 degrees when the end table is utilized.



- Thick insulation protects hot or cold meals, while venting increases air circulation to maintain food quality.
- Tough, one-piece double-wall polyethylene carts are durable and easy to clean, resisting rust, dents, chipping, or breakage.

- Features non-marking, quiet casters for easy maneuverability and to optimize patient rest. MDC1411T60 comes standard with plated casters.

- Lightweight doors allow for fast and quiet access to trays during service.

10-TRAY DUAL ACCESS AND SINGLE DOOR ROOM SERVICE CART – LOW PROFILE



Single door 10-Tray Meal Delivery Cart is covered by U.S. Patent D 723,237 S.



CODE	MDC1520S10D	MDC1520S10	MDC1520S10HD
TRAY SIZE	38 x 51 / 37 x 53 cm	38 x 51,5 cm / 37 x 53 cm	38 x 51,5 cm / 37 x 53 cm
TRAYS PER RAIL / RAIL SPACING	2 / 13,3 cm	2 / 13,3 cm	2 / 13,3 cm
TRAYS PER COMPARTMENT	10	10	10
EXTERNAL DIMENSIONS W x D x H	77,5 x 97,5 x 109 cm	77,5 x 97,5 x 109 cm	77,5 x 97,5 x 110,5 cm
INTERNAL DIMENSIONS W x D x H	53,6 x 78,7 x 66,6 cm	53,7 x 78,7 x 66,7 cm	53,7 x 78,7 x 66,7 cm
CASTER TYPE	Nylon, 12,7 cm 2 rigid, 2 swivel with brake	Nylon, standard casters 12,7 x 3,2 cm	15,2 Heavy Duty casters, 2 front rigid, 2 rear swivel with brake
UNIT WEIGHT	42 kg	35,4 kg	46,3 kg

Case Pack: 1 Colors: Granite Gray (191) and Granite Sand (194).

Airpot and Condiment Station

- Holds three airpots for safe transport and service.
- Compartments are designed for stir sticks, napkins and a variety of condiments.
- Stain and odor resistant.
- Made of durable ABS material.
- Fits Cambro's 10-tray room service carts.

BSACS patent applied for.



CODE	DIMENSIONS W x D x H	CASE PACK
BSACS	59 x 39 x 15,2 cm	1

Color: Black (110). Airpots not included.



20-TRAY MEAL DELIVERY CART – LOW PROFILE



Marine rail is designed for use during service, not transport.



CODE	MDC1520S20	MDC1418S20
TRAY SIZE	38 x 51,5 cm	36 x 46 cm
TRAYS PER CART / PER COMPARTMENT	20 / 10	20 / 10
RAILS PER COMPARTMENT	5	5
TRAYS PER RAIL / RAIL SPACING	2 / 14 cm	2 / 14 cm
NUMBER OF COMPARTMENTS AND VENTS	2	2
NUMBER OF MENU CLIPS	2	2
MENU CLIPS - LOCATION	1 per door	1 per door
HANDLES - TYPE AND LOCATION	Molded in, each end	Molded in, each end
CASTER TYPE	15,24 cm nylon, 2 swivel with brake / 2 Rigid	Nylon, 12,7 cm, 2 swivel w/brake, 2 rigid, offset
LATCHES	Lockable paddle latches, 1 per door, 2 total	2 internal nylon friction
EXTERNAL DIMENSIONS W x L x H	92,1 x 122,6 x 144,3 cm	82,6 x 123,2 x 111,8 cm
INTERNAL DIMENSIONS W x D x H	52,4 x 78,1 x 69,9 cm	46,7 x 71,1 x 73,7 cm
REQUIRED DOOR WIDTH	72,39 cm	83,82 cm
UNIT WEIGHT	58,06 kg	64,18 kg
CASE PACK	1	1
COLORS (All carts with cream color doors)	Granite Gray (191), Granite Sand (194)	Slate Blue (401), Granite Gray (191), Granite Green (192), Granite Sand (194)

TALL 20-TRAY MEAL DELIVERY CART WITH OPTIONAL END TABLE



Optimize space while allowing for a large capacity to serve meals with in-room service. Operators can conveniently use the end table to set up the tray and meal for the next patient as they manage the delivery process. The end table simply folds down and fits the side of the cart, allowing for easy accessibility.

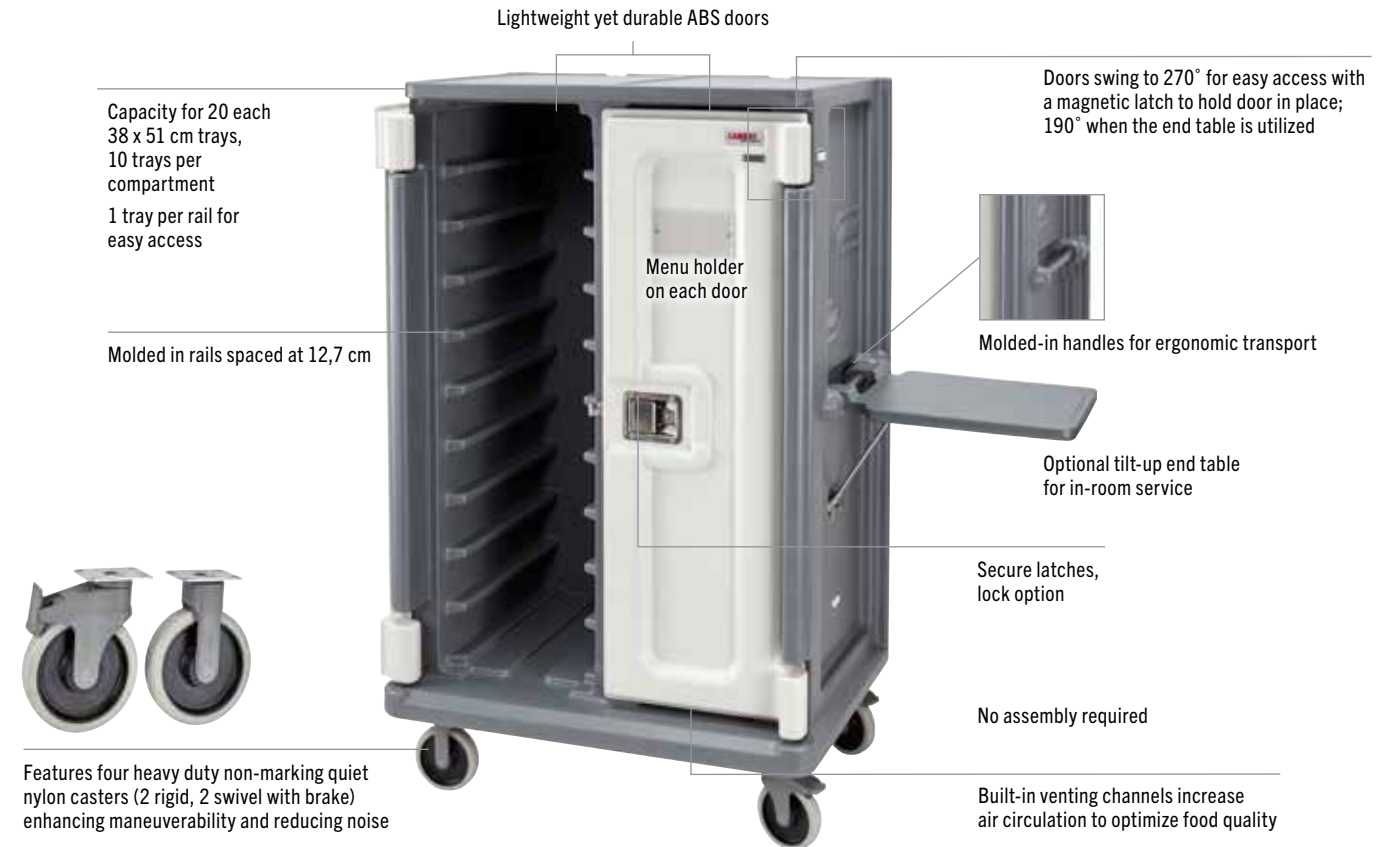

CODE	MDC1520T20
TRAY SIZE	38 x 51 cm
TRAYS PER CART / PER COMPARTMENT	20 / 10
RAILS PER COMPARTMENT	10
TRAYS PER RAIL / RAIL SPACING	12,7 cm
HANDLES – TYPE AND LOCATION	Molded in, each end
CASTER TYPES	15,24 cm nylon, 2 swivel with brake / 2 Rigid
LATCHES	Lockable paddle latches, 1 per door, 2 total
EXTERNAL DIMENSIONS L x W x H	102,36 x 72,39 x 163,2 cm
INTERNAL DIMENSIONS L x W x H	38,86 x 53,6 x 128,91 cm
REQUIRED DOOR WIDTH	72,39 cm
UNIT WEIGHT KGS	64,86 kg
CASE KG (M³)	82,27 kg (1,41) not including pallet
Case Pack: 1	Colors: Granite Gray (191), Granite Sand (194). All carts with cream color doors.

Optional Accessory



MDCET

Optional End Table

Overall Exterior Dimensions L x W x H:
57,79 x 41,91 x 6,6 cm

Color: Granite Gray (191)

16 AND 30 TRAY MEAL DELIVERY CARTS – TALL PROFILE



Marine rail is designed for use during service, not transport.



Tall Profile

SPECIFICATIONS	MDC1520T30	MDC1520T16**	MDC1418T30	MDC1418T16**
TRAY SIZE	38 x 51,5 cm	38 x 51,5 cm	36 x 46 cm	36 x 46 cm
TRAYS PER CART	30	16	30	16
TRAYS PER COMPARTMENT	10	16	10	16
RAILS PER COMPARTMENT	10	8	10	8
TRAYS PER RAIL	1	2	1	2
RAIL SPACING	12,7 cm	13,3 cm	12,7 cm	13,3 cm
NUMBER OF DOORS	3	1	3	1
NUMBER OF COMPARTMENTS	3	1	3	1
NUMBER OF MENU CLIPS	5	1	5	1
MENU CLIPS - LOCATION	Each door, each end	Door	Each door, each end	Door
HANDLES - TYPE AND LOCATION	Heavy-duty nylon, mounted 1 per end	Molded-in, 1 per end MDCET16 optional accessory	Heavy-duty nylon, mounted 1 per end.	Molded-in, 1 per end MDCET16 optional accessory
CASTER TYPE	Nylon, 15,2 cm, 2 rigid, 4 swivel w/brake, offset	Nylon, 15,2 cm, 2 rigid, 2 swivel w/brake	Nylon, 15,2 cm, 2 rigid, 4 swivel w/brake, offset	Nylon, 15,2 cm, 2 rigid, 2 swivel w/brake
LATCHES	Friction catch, transit latch*	Lockable paddle latch	Friction catch, transit latch*	Large paddle latch
EXTERNAL DIMENSIONS W x L x H	74,3 x 152,4 x 161,6 cm	69,1 x 95,5 x 147,3 cm	74,3 x 152,4 x 161,6 cm	63,91 x 90,48 x 147,32 cm
INTERNAL DIMENSIONS W x D x H	39 x 53,34 x 127 cm	52,4 x 78,1 x 110,8 cm	37 x 55 x 127 cm	47,30 x 72,39 x 113,34 cm
REQUIRED DOOR WIDTH	77 cm	78 cm	77 cm	79 cm
UNIT WEIGHT	95,25 kg	48,53 kg	97,07 kg	45,13 kg

Case Pack: 1 **Colors:** Slate Blue (401), Granite Grey (191), Granite Green (192), Granite Sand (194). (All carts with cream door.)

*Stainless steel transit latch at top of each door. MDC1418T16 are covered by U.S. Patent D 398,727.

For lighter-duty applications, 30-tray carts may be ordered without the steel transit latches by using product code MDC1520T30NL or MDC1418T30NL.

**MDC1520T16, MDC1418T16 comes in Granite Gray (191) and Granite Sand (194) only.

60-TRAY MEAL DELIVERY CART FOR CORRECTIONAL TRAY SERVICE



- For use in correctional facilities.
- Holds 60 each 1411CW or 1411CP Cambro Base Trays with 853 Insert Trays or 60 each 10146DCW or 10146DCP Separator Compartment Trays.
- Security features include security screws on handles, stop locks on door knuckles, security bolts for transit latches and caster carriage bolts with lock nuts.



1411CP base tray with 853FH insert tray

CODE	MDC1411T60
TRAY SIZE	35,6 x 27,9 cm base tray 1411CW and 1411CP
TRAYS PER CART / PER COMPARTMENT	60 / 20
RAILS PER COMPARTMENT	10
TRAYS PER RAIL / RAIL SPACING	2 / 12,7 cm
NUMBER OF COMPARTMENTS	3
HANDLES - TYPE AND LOCATION	Heavy-duty aluminum with security screws, black finish, 1 per end
CASTER TYPE	15,2 cm heavy-duty casters, 5,1 cm wide tread, 2 swivel with brake, 2 rigid
LATCHES	Internal friction catch, 2 per door, transit latch*
EXTERNAL DIMENSIONS W x L x H	74,3 x 152,4 x 161,6 cm
INTERNAL DIMENSIONS W x D x H	36,8 x 54,6 x 127 cm
REQUIRED DOOR WIDTH	76,2 cm
UNIT WEIGHT	97,98 kg

Case Pack: 1 Colors: Granite Gray (191), Granite Sand (194), Slate Blue (401).
*Stainless steel transit latch at top of each door.

MEAL DELIVERY CARTS FEATURES AND CASTER CONFIGURATIONS

Standard Caster Configurations:

These caster configurations are designed to provide stability and maneuverability over uneven surfaces.

For optional caster configurations, contact your Cambro representative.

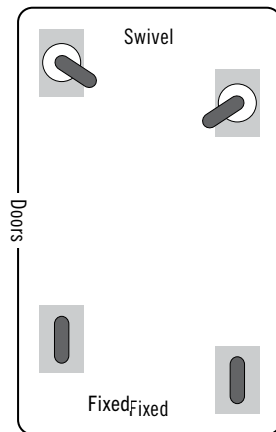

MDC1520S20, MDC1418S20, MDC1520T20, MDC1411T60

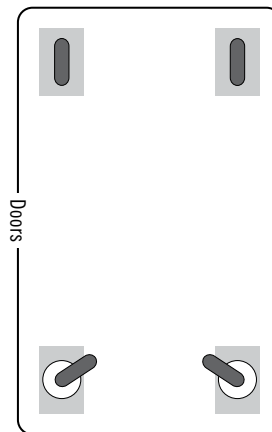

MDC1520S10, MDC1520S10D, MDC1520T16, MDC1418T16, MDC1520T20

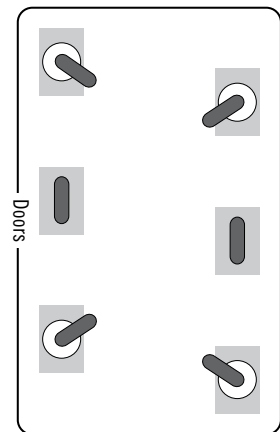

MDC1520T30, MDC1418T30

Handles

MDC1520S20, MDC1418S20



Molded in handles on each end for smooth transporting.

MDC1520T16, MDC1418T16



Molded in handles for easy transporting.

MDC1520T20, MDC1520T30, MDC1418T30, MDC1411T60**



Heavy duty nylon handles are securely mounted and nested into each end. **MDC1411T60 has tamper resistant heavy duty aluminum tubing handles.

Lead in Casters



Castors are offset to ease movement over uneven surfaces. This is standard on MDC1520S10, MDC1520S10D, MDC1520S20, MDC1418S20, MDC1520T20, MDC1520T30, MDC1418T30 and MDC1411T60.

CAMBRO® EQUIPMENT COLOR CHART



Gray (180)



Coffee Beige (157)



Hot Red (158)

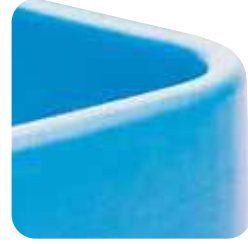

Cold Blue (159)



Speckled Gray (480)



Dark Taupe (417)



Brick Red (402)



Navy Blue (186)



Granite Gray (191)



Granite Sand (194)

Cambro provides a wide selection of colors to help you coordinate with your decor and color code items to simplify use.

Color selections vary by product. Please see individual products for specific colors offered.

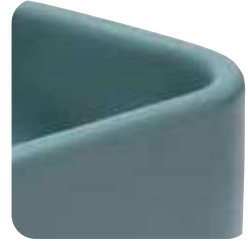

Slate Blue (401)



Charcoal Gray (615)



Dark Brown (131)



Granite Green (192)



Black (110)



Kentucky Green (519)

CAMBRO® APP



Download the Cambro App!

Access helpful Cambro tools and resources on the go with the Cambro App.

Customize a tray, find the right lid for your containers, play the trivia challenge to win free products and more!

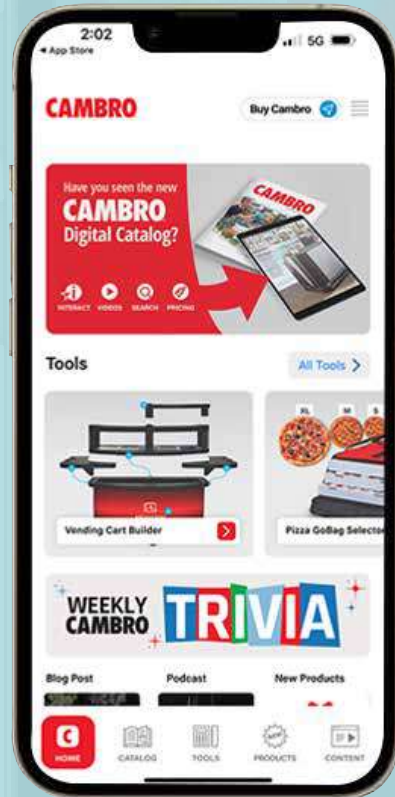

Cambro® Warranty

Cambro offers a 5-year pro-rated warranty against damage or manufacturer's defects found in excess to normal wear and tear on our Camtrays®, Camtread® trays and Dinnerware. Commercial Electrical Equipment models hold a 1-year warranty. Non-Skid Versa Camtrays, Tongs, Camwear® Food Storage Pans, all high heat material products, Squares, Rounds and Lids have a 2-year pro-rated warranty. All Camshelving® Series have a 1-year warranty on workmanship and a lifetime limited warranty against rust and corrosion, excluding mobile posts. For all other Cambro products, Cambro warrants to the original buyer a 3-year pro-rated warranty unless otherwise noted. If product proves defective during this time, Cambro grants a pro-rated credit of the original price toward replacement product. The warranty applies on all Cambro products only when used under normal foodservice industry conditions.

Note: Temperature ranges noted throughout this catalog are based on specific test criteria and provide a general guideline. Individual use may vary due to differences in loading temperatures or ambient temperature.

Product Accessories: Contents and accessories shown in photos are not included, except where noted.

Photo credits:

Cambro products help foodservice operators throughout the world. To represent our global presence, images of Cambro products in use have been taken on locations throughout southern California, USA; in Cancun, Mexico; on the island of Rugen, Germany; and in the city of Huizhou, China. In particular, special thanks to the staffs of the Ambience Hotel, Rugen; Jin Hua Palace Hotel, Huizhou; Southern California Gas Company, Downey; Orange Coast College, Santa Ana and California Hospital, Los Angeles for their assistance in our photo shoots.



CAMBRO U.S.A.
TEL: 1(714) 848-1555
FAX: 1(714) 843-2630
international@cambro.com

CAMBRO EUROPE
TEL: (49) 7022 90 100 0
FAX: (49) 7022 90100 19
cambroeuropa@cambro.com

CAMBRO UK
TEL: 0800 587 0057 Toll Free
FAX: 0845 280 3411
cambrouk@cambro.com

CAMBRO IRELAND
TEL: 1800 509 046 Toll Free
FAX: 01 633 55 76
cambroireland@cambro.com

