



DEGRENNE

Since 1948



2025



Plus de 75 ans après sa création, la Maison DEGRENNE, Fabricant Français d'arts de la table premium, est toujours une entreprise familiale gérée par la famille SPRUCH.

Les 4 frères de la famille : Antoine, Marc-Alain, Benjamin et Thomas, s'engagent tous les jours pour développer et réinventer cette Maison Française.

La Maison DEGRENNE perpétue, transmet et revisite les savoir-faire de ses artisans dans ses trois Manufactures : à Vire en Normandie pour les couverts et la platerie, en acier inoxydable et en métal argenté, à Limoges pour la porcelaine fine extra blanche et en Hongrie pour la porcelaine de couleur.

Dans ses Manufactures, DEGRENNE associe le meilleur des deux mondes : l'artisanat et l'industrie, en réinventant des gestes artisanaux et en les adaptant à un process industriel de moyennes séries.

Les savoir-faire des artisans orfèvres et porcelainiers des Manufactures DEGRENNE sont reconnus et sélectionnés par les plus exigeants : les plus beaux hôtels et restaurants, de Paris à New-York City en passant par Séoul, les Maisons de Luxe les plus prestigieuses, les grandes compagnies aériennes.

La famille SPRUCH et toutes les équipes de la Maison DEGRENNE sont fières de vous accompagner et de vous proposer dans ce catalogue ses collections de couverts, platerie, vaisselle et verrerie, qui marient qualité, intemporalité, design et usage. Ces collections DEGRENNE, toutes au service des Chefs, sont pensées et réalisées pour vous inspirer et pour mettre en valeur vos plus belles créations.

More than 75 years after its creation, the DEGRENNE House, a French manufacturer of premium tableware, remains a family-run business managed by the SPRUCH family.

The four brothers of the family : Antoine, Marc-Alain, Benjamin and Thomas commit themselves every day to developing and reinventing this French Maison.

DEGRENNE perpetuates, transmits, and revisits the expertise of its craftsmen in its three Manufactures: in Vire, Normandy, for cutlery and silverware in stainless steel and silver-plated metal in Limoges for extra-white fine porcelain and in Hungary for colored porcelain.

In its Manufactures, DEGRENNE combines the best of both worlds : craftsmanship and industry, reinventing artisanal gestures and adapting them to a medium-scale industrial process.

The know-how of the goldsmiths and porcelain makers in the DEGRENNE Manufactures is recognized and selected by the most demanding clientele : the finest hotels and restaurants from Paris to New York City to Seoul, as well as the most prestigious Luxury Houses and major airlines.

The SPRUCH family and all the teams at DEGRENNE are proud to accompany and present in this catalog their collections of cutlery, silverware, tableware, and glassware, which blend quality, timelessness, design, and functionality. DEGRENNE collections, all at the service of chefs, are designed and created to inspire you and showcase your most beautiful creations.

PARTENAIRES D'EXCELLENCE

Partners of excellence



ILS NOUS FONT CONFIANCE

They trust us

ACCOR HOTELS

FAIRMONT
PULLMAN
RAFFLES
SOFITEL /BARRIÈRE

AMAN RESORTS

AUBERGE RESORTS

ELEVEN MADISON PARK

LE BERNARDIN

FOUR SEASONS

HILTON WORLDWIDE

INTERCONTINENTAL

LOUVRE HOTELS

GOLDEN TULIP

LUTETIA

MANDARIN ORIENTAL

MARRIOTT

RITZ CARLTON
ST REGIS HOTELS & RESORTS
W HOTELS

MJM RESORTS

BELLAGIO
MJM GRAND
ARIA

ONE AND ONLY RESORTS

PENINSULA

SOCIETE DES BAINS DE MER

WALDORF ASTORIA

LE COUVERT FLATWARE

CLASSIQUE CLASSICAL

ABSOLU	10-11
BLOIS	12-15
CONFIDENCE	16-17
CONTOUR	18-19
COUTEAUX STEAK	86-88
FLORENCIA	20-21
LE PHIL	86
LE PHIL VINTAGE NEW	86
LUTÈCE	22-23
MARQUISE	24-25
MIKADO MIROIR	26-27
MIKADO VINTAGE	28-29
MILADY	30-31
MIRAGE STEAK	86
MIRAGE LES ESSENCES	86
NEUILLY	32-33
NORMANDY	34-35
PETIT GOURMET	88
SWELL NEW	36-37
VERLAINE	38-39
VIEUX PARIS SATINÉ	40-41

DESIGN

AQUATIC MIROIR	44-45
ASTRÉE CISELÉ	46-47
COUTURE	48-49
FUSE MIROIR	50-51
FUSE MARTELÉ	52-53
GUEST CUIVRE	56-57
GUEST MIROIR	54-55
GUEST STAR	58-59
GUEST VINTAGE	60-61
L'EMPREINTE	62-63
L'E STARCK®	64-65
NORWAY	66-67
ONDE MIROIR	68-69
ONDE GOLD	70-71
OVATION	72-73
RIVAGE NEW	74-75
SOLSTICE	76-77
SUPERNATURE	78-79
XY MIROIR	80-81
XY BLACK MIROIR	82-83

PIÈCES COMPLÉMENTAIRES ADDITIONAL PIECES

ABSOLU	10-11
BLOIS	12-15
CONFIDENCE	16-17
CONTOUR	18-19
COUTEAUX STEAK	86-88
FLORENCIA	20-21
LE PHIL	86
LE PHIL VINTAGE NEW	86
LUTÈCE	22-23
MARQUISE	24-25
MIKADO MIROIR	26-27
MIKADO VINTAGE	28-29
MILADY	30-31
MIRAGE STEAK	86
MIRAGE LES ESSENCES	86
NEUILLY	32-33
NORMANDY	34-35
PETIT GOURMET	88
SWELL NEW	36-37
VERLAINE	38-39
VIEUX PARIS SATINÉ	40-41

LA VAISSELLE DINNERWARE

PORCELAINE DE LIMOGES LIMOGES PORCELAIN

ÉCLIPSE	106-107
GALON OR	108-109
GALON PLATINE	110-111
L	96-99
L COUTURE	100-101
L FRAGMENT	102-103
L PERLES DE ROSÉE	104-105
REMINISCENCE	112-113
SD ONE	114-115
SD ONE OR	114-115
SUPERNATURE	116-117
SUPERNATURE OR	116-117

CÉRAMIQUE CERAMIC

BAHIA	120-125
BLUE SHADES	126-127
BORÉAL	128-129
BORÉAL ONDE NEW	130-131
BORÉAL SATIN BLANC	132-133
BORÉAL SATIN GOLD	132-133
BRUME	134-135
COCOTTES	136-139
COURONNE DORÉE NEW	140-141
COURONNE ARGENTÉE NEW	142-143
ECLATS NEW	140-141
GRAPHIQUE CLASSIQUE	144-145
GRAPHIQUE CLASSIQUE DORÉ	144-145
LA VAISSELLE DE LECONOME	146-147
MODULO	148-151
MODULO NATURE	152-157
RIVAGE	158-159

CAFÉTERIE TEATIME

EMPILEO	168-169
BOREAL	176-177
BOREAL SATIN	176-177
COURONNE ARGENTÉ	178-179
COURONNE DORÉ	178-179
GALON OR	174-175
GALON PLATINE	174-175
GRAPHIQUE CLASSIQUE	180-181
GRAPHIQUE CLASSIQUE DORÉ	180-181
L	172
L COUTURE	172
L FRAGMENT	172
L PERLES DE ROSÉE	172
MODULO NEW	170
MODULO NATURE	184-185
NEWPORT	182-183
SALAM	162-165
SALAM MONOCHROME	166-167
SALAM THÉ	170-171
SD ONE	172

LE VERRE GLASSWARE

À PIED STEMMED GLASS

ALLURE	190-191
ANYTIME	192-193
DOMAINE	194-195
HYPNOTIC JAUGÉ	198
GALATÉE	196-197
MONTMARTRE	198-199
MONTMARTRE JAUGÉ	198
MUSE	200-201
NEWPORT TWIST	202-203
ORIGINE	192

GOBELET ET CARAFE TUMBLER & CARAFE

ALLEGRO	206-207
ALLURE	190
COSMOPOLITAIN	208-209
CARAFES - DÉCANTEURS	214-215
DOLCE	208-209
EMPILEO	210-211
GALATEE	196
INSTANT	212
LOOP	212
MAMBO	213
MUSE	200
ROC	213

LA PLATERIE HOLLOWARE

NEWPORT ACCESSOIRES	228-229
NEWPORT BAR	226-227
NEWPORT CAFÉTERIE	224-225
NEWPORT PLATEAUX CUBIQUE	220-221
NEWPORT PLATEAUX MIROIR	218-219
NEWPORT SERVICE À TABLE	222-223
NORMANDY	218

LE BUFFET EVENTO

ACCESSOIRES	248-249
CHAFING DISHES	232-235
DISTRIBUTEURS À CÉRÉALES	241
MODULES FROIDS	236-239
PIÈCES DÉTACHÉES	252-253
PLAN	250-251
PLANCHES LES ESSENCES	246-247
SUPPORTS À FIL RECTANGULAIRES	243-245
SUPPORTS À FIL RONDS	243-245
URNES À JUS DE FRUITS	240

LES BASIQUES BASIC'S

AMAZONE	256-257
BAR	256
CASSIOPEE	258-259
ESSENTIELLE	260-261
GLORIA	262-263
UNISSET	264-265
VITAL	266-267
UNI	268-271

LES COLLECTIONS

RANGES



LE COUVERT

Flatware

Les ateliers DEGRENNE donnent forme aux majestueuses bobines d'acier inoxydable et transforment la matière brute en couverts. Les couverts DEGRENNE bénéficient d'un savoir-faire unique et se caractérisent par une ergonomie et une résistance exceptionnelle.

Faciles d'entretien, ils répondent aux critères les plus exigeants de qualité, de fonctionnalité et d'esthétique. La qualité du design et le soin apporté aux finitions font de chacun de nos couverts de véritables pièces d'orfèvre de style classique ou contemporain. Créé en collaboration avec des chefs ou en laissant libre cours à l'imagination de nos designers, aux lignes sobres ou plus élaborées, chaque modèle DEGRENNE trouve sa place à table.

DEGRENNE'S workshops shape the impressive reels of stainless steel and transform the raw material into cutlery. We use our unique expertise to create our cutlery, which is characterized by being extraordinarily easy to use and sturdy. DEGRENNE cutlery is easy to look after and meets the most stringent quality, functionality and appearance criteria. The design quality and painstaking finishes make each of our items of cutlery true pieces of classic or contemporary silverware. DEGRENNE cutlery is designed in partnership with chefs or by giving our designers free rein. Some items have simple lines, while others are more elaborate, but every DEGRENNE design takes pride of place on a table.

Découvrez les coulisses de notre Manufacture à Vire
Discover our factory in Vire





LE COUVERT CLASSIQUE

Classical Flatware



126556
FOURCHETTE DE TABLE
TABLE FORK
20,2 CM - 7 IN^{15/16}



126578
FOURCHETTE À POISSON
FISH FORK
18 CM - 7 IN^{1/16}



126565
COUTEAU DE TABLE
MANCHE ORFÈVRE LAME UNIE
TABLE KNIFE HOLLOW HANDLE
23 CM - 9 IN^{1/16}



126581
COUTEAU À POISSON
FISH KNIFE
20,1 CM - 7 IN^{15/16}



130332
COUTEAU DE TABLE
MANCHE ORFÈVRE LAME SCIE
TABLE KNIFE HOLLOW HANDLE SERRATED
23 CM - 9 IN^{1/16}



126559
CUILLÈRE À CAFÉ
COFFEE/TEA SPOON
13,9 CM - 5 IN^{1/2}



126553
CUILLÈRE DE TABLE
TABLE/PASTA SPOON
20,5 CM - 8 IN^{1/16}



155452
CUILLÈRE À MOKA
DEMI TASSE SPOON
11,1 CM - 4 IN^{3/8}



155528
CUILLÈRE À SOUPE ANGLAISE
BOUILLON SPOON, ROUND
17,5 CM - 6 IN^{7/8}



126591
FOURCHETTE DE SERVICE
SERVING FORK
24,8 CM - 9 IN^{3/4}



126569
CUILLÈRE À DESSERT
DESSERT/SOUP SPOON, OVAL
18 CM - 7 IN^{1/16}



126589
CUILLÈRE DE SERVICE
SERVING SPOON
25 CM - 9 IN^{13/16}



126572
FOURCHETTE À DESSERT
DESSERT/SALAD FORK
18 CM - 7 IN^{1/16}



126587
PELLE À TARTE
MANCHE ORFÈVRE
PASTRY SERVER HOLLOW HANDLE
24 CM - 9 IN^{7/16}



126575
COUTEAU À DESSERT
MANCHE ORFÈVRE LAME UNIE
DESSERT KNIFE HOLLOW HANDLE
20,5 CM - 8 IN^{1/16}



154828
COUTEAU À BEURRE
MANCHE ORFÈVRE LAME UNIE
BUTTER KNIFE HOLLOW HANDLE
18,8 CM - 7 IN^{3/8}

EGALEMENT DISPONIBLE EN MÉTAL ARGENTÉ
ALSO AVAILABLE IN SILVERPLATED FINISH



Possibilité de personnalisation
Bespoke options available



ABSOLU

Finedining





104485
FOURCHETTE DE TABLE
TABLE FORK
20,8 CM - 8 IN^{3/16}



182466
COUTEAU DE TABLE
MONOBLOC LOURD LAME SCIE
TABLE KNIFE HEAVY SOLID HANDLE
SERRATED
24,6 CM - 9 IN^{11/16}



161390
COUTEAU DE TABLE
MANCHE ORFÈVRE LAME UNIE
TABLE KNIFE HOLLOW HANDLE
24,6 CM - 9 IN^{11/16}



161391
COUTEAU DE TABLE
MANCHE ORFÈVRE LAME SCIE
TABLE KNIFE HOLLOW HANDLE SERRATED
24,6 CM - 9 IN^{11/16}



122759
COUTEAU À STEAK
MANCHE ORFÈVRE LAME SCIE
STEAK KNIFE HOLLOW HANDLE SERRATED
23,9 CM - 9 IN^{7/16}



104526
CUILLÈRE DE TABLE
TABLE/PASTA SPOON
20,8 CM - 8 IN^{3/16}



104448
CUILLÈRE À SOUPE ANGLAISE
BOUILLON SPOON, ROUND
17,2 CM - 6 IN^{3/4}



104484
CUILLÈRE À DESSERT
DESSERT/SOUP SPOON, OVAL
18 CM - 7 IN^{1/16}



104543
FOURCHETTE À DESSERT
DESSERT/SALAD FORK
17,8 CM - 7 IN



182467
COUTEAU À DESSERT
MONOBLOC LOURD LAME UNIE
DESSERT KNIFE HEAVY SOLID HANDLE
20,5 CM - 8 IN^{1/16}



161394
COUTEAU À DESSERT
MANCHE ORFÈVRE LAME UNIE
DESSERT KNIFE HOLLOW HANDLE
20,5 CM - 8 IN^{1/16}



190419
COUTEAU À BEURRE
MONOBLOC LOURD LAME UNIE
BUTTER KNIFE HEAVY SOLID HANDLE
18,7 CM - 7 IN^{3/8}



122760
COUTEAU À BEURRE
MANCHE ORFÈVRE LAME UNIE
BUTTER KNIFE HOLLOW HANDLE
18,7 CM - 7 IN^{3/8}

EGALEMENT DISPONIBLE EN MÉTAL ARGENTÉ
ALSO AVAILABLE IN SILVERPLATED FINISH



Possibilité de personnalisation
Bespoke options available

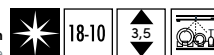

BLOIS

Finedining



MADE IN FRANCE





104507
FOURCHETTE POISSON
FISH FORK
17,7 CM - 6 IN^{15/16}



104508
COUPEAU POISSON
FISH KNIFE
19,9 CM - 7 IN^{13/16}



145451
CUILLÈRE À SAUCE GOURMET
GOURMET/SAUCE SPOON
17,9 CM - 7 IN^{1/16}



104561
CUILLÈRE À CAFÉ
COFFEE/TEA SPOON
14 CM - 5 IN^{1/2}



109465
CUILLÈRE À MOKA MIKADO
DEMI TASSE SPOON
11 CM - 4 IN^{5/16}



124259
CUILLÈRE À SODA
ICED TEA SPOON
18,2 CM - 7 IN^{3/16}



104480
FOURCHETTE À GÂTEAUX/ COCKTAIL
PASTRY/COCKTAIL FORK
13,8 CM - 5 IN^{7/16}



104463
FOURCHETTE À HUITRES
OYSTER FORK
13 CM - 5 IN^{3/8}



189208
COUPEAU À FROMAGE MANCHE ORFÈVRE LAME UNIE
CHEESE KNIFE HOLLOW HANDLE
19,3 CM - 7 IN^{5/8}



195757
FOURCHETTE DE SERVICE
SERVING FORK
24,8 CM - 9 IN^{3/4}



195755
CUILLÈRE DE SERVICE
SERVING SPOON
25 CM - 9 IN^{13/16}



195757
FOURCHETTE À DÉCOUPER
CARVING FORK
24,8 CM - 9 IN^{3/4}



189511
COUPEAU À DÉCOUPER MANCHE ORFÈVRE LAME UNIE
CARVING KNIFE HOLLOW HANDLE
28,7 CM - 11 IN^{5/16}



195750
SERVICE À SALADE
SALADE SERVING SET
25,7 CM - 10 IN^{1/8}



195753
PELLE À TARTE MONOBLOC
PASTRY SERVER SOLID HANDLE
24,9 CM - 9 IN^{13/16}



195762
LOUCHE
SOUP LADLE
29,8 CM - 11 IN^{3/4}



195759
LOUCHE À SAUCE
SAUCE LADLE
15,7 CM - 6 IN^{3/16}

EGALEMENT DISPONIBLE EN MÉTAL ARGENTÉ
ALSO AVAILABLE IN SILVERPLATED FINISH



Possibilité de personnalisation
Bespoke options available



BLOIS

Finedining

MADE IN FRANCE





141094
FOURCHETTE DE TABLE
TABLE FORK
20,3 CM - 8 IN



103857
COUTEAU DE TABLE
MONOBLOC LAME SCIE
TABLE KNIFE SOLID HANDLE
SERRATED
23,7 CM - 9 IN^{5/16}



160433
COUTEAU À STEAK
MONOBLOC LAME SCIE
STEAK KNIFE SOLID HANDLE SERRATED
23,6 CM - 9 IN^{5/16}



141092
CUILLÈRE DE TABLE
TABLE/PASTA SPOON
20,4 CM - 8 IN^{1/16}



105908
CUILLÈRE À SOUPE ANGLAISE
VERLAINE
BOUILLON SPOON, ROUND
17,2 CM - 6 IN^{3/4}



108232
CUILLÈRE À DESSERT
DESSERT/SOUP SPOON, OVAL
17,9 CM - 7 IN^{7/16}



108234
FOURCHETTE À DESSERT
DESSERT/SALAD FORK
17,8 CM - 7 IN



210628
COUTEAU À DESSERT
MONOBLOC LAME SCIE
DESSERT KNIFE SOLID HANDLE
20,6 CM - 8 IN^{1/8}



103564
CUILLÈRE À CAFÉ
COFFEE/TEA SPOON
13,5 CM - 5 IN^{5/16}



109471
CUILLÈRE À MOKA
DEMI TASSE SPOON
11 CM - 4 IN^{5/16}



105800
CUILLÈRE À SODA
VERLAINE
ICED TEA SPOON
18,2 CM - 7 IN^{3/16}



132782
FOURCHETTE À ESCARGOTS
SNAIL FORK
13,5 CM - 5 IN^{5/16}

SUGGESTION PIÈCES DE SERVICE
SUGGESTED SERVING PIECES
VERLAINE



002185
FOURCHETTE DE SERVICE
SERVING FORK
24,8 CM - 9 IN^{3/4}



002186
CUILLÈRE DE SERVICE
SERVING SPOON
25 CM - 9 IN^{13/16}



040646
SERVICE À SALADE
SALAD SERVING SET
25,8 CM - 10 IN^{3/16}



083340
PELLE À TARTE MONOBLOC
PASTRY SERVER SOLID HANDLE
24,9 CM - 9 IN^{3/16}



097717
LOUCHE
SOUP LADLE
29,8 CM - 11 IN^{3/4}



002179
LOUCHE À SAUCE
SAUCE LADLE
15,7 CM - 6 IN^{3/16}

EGALEMENT DISPONIBLE EN MÉTAL ARGENTÉ
ALSO AVAILABLE IN SILVERPLATED FINISH



Possibilité de personnalisation
Bespoke options available



CONFIDENCE

Alldaydining





104729
FOURCHETTE DE TABLE
TABLE FORK
21 CM - 8 IN^{3/4}



104728
COUPEAU DE TABLE
MANCHE ORFEVRE LAME SCIE
TABLE KNIFE HOLLOW HANDLE
SERRATED
25 CM - 9 IN^{13/16}



104712
CUILLÈRE DE TABLE
TABLE/PASTA SPOON
21 CM - 8 IN^{3/4}



186291
CUILLÈRE À SOUPE ANGLAISE
BOUILLON SPOON, ROUND
17,4 CM - 8 IN^{7/8}



104752
CUILLÈRE À DESSERT
DESSERT/SOUP SPOON, OVAL
18,1 CM - 7 IN^{1/8}



104765
FOURCHETTE À DESSERT
DESSERT/SALAD FORK
18,1 CM - 7 IN^{1/8}



104779
COUPEAU À DESSERT
MANCHE ORFEVRE LAME UNIE
DESSERT KNIFE HOLLOW HANDLE
21 CM - 8 IN^{1/4}



186294
COUPEAU À BEURRE
MANCHE ORFEVRE
BUTTER KNIFE HOLLOW HANDLE
19,2 CM - 7 IN^{9/16}



104766
CUILLÈRE À CAFÉ
COFFEE/TEA SPOON
14,4 CM - 5 IN^{11/16}



104707
FOURCHETTE À POISSON
FISH FORK
17,9 CM - 7 IN^{1/16}



104727
COUPEAU À POISSON
FISH KNIFE
20 CM - 7 IN^{7/8}

EGALEMENT DISPONIBLE EN MÉTAL ARGENTÉ
ALSO AVAILABLE IN SILVERPLATED FINISH



Possibilité de personnalisation
Bespoke options available

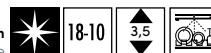

CONTOUR

Finedining



MADE IN FRANCE





126077
FOURCHETTE DE TABLE
TABLE FORK
20,8 CM - 8 IN^{3/16}



126099
FOURCHETTE À POISSON
FISH FORK
17,7 CM - 6 IN^{5/16}



190643
COUTEAU DE TABLE
MONOBLOC LOURD
LAME SCIE
TABLE KNIFE SOLID HANDLE SERRATED
24,6 CM - 9 IN^{17/16}



126102
COUTEAU À POISSON
FISH KNIFE
19,9 CM - 7 IN^{13/16}



130140
COUTEAU DE TABLE
MANCHE ORFÈVRE DROIT LAME SCIE
TABLE KNIFE HOLLOW HANDLE SERRATED
24,6 CM - 9 IN^{17/16}



126080
CUILLÈRE À CAFÉ
COFFEE/TEA SPOON
14 CM - 5 IN^{17/2}



127654
COUTEAU À STEAK
MANCHE ORFÈVRE DROIT LAME SCIE
STEAK KNIFE HOLLOW HANDLE SERRATED
23,9 CM - 9 IN^{7/16}



126105
CUILLÈRE À MOKA
DEMI TASSE SPOON
11 CM - 4 IN^{5/16}



126074
CUILLÈRE DE TABLE
TABLE/PASTA SPOON
20,8 CM - 8 IN^{3/16}



126108
FOURCHETTE À GÂTEAUX/
COCKTAIL
PASTRY/COCKTAIL FORK
13,8 CM - 5 IN^{7/16}



126090
CUILLÈRE À DESSERT
DESSERT/SOUP SPOON, OVAL
18 CM - 7 IN^{1/16}



190418
FOURCHETTE À HUÎTRES
OYSTER FORK
13 CM - 5 IN^{1/8}



126093
FOURCHETTE À DESSERT
DESSERT/SALAD FORK
17,8 CM - 7 IN

SUGGESTION PIÈCES DE SERVICE
SUGGESTED SERVING PIECES
VERLAINE



190644
COUTEAU À DESSERT
MONOBLOC LOURD LAME UNIE
DESSERT KNIFE HEAVY SOLID HANDLE
20,5 CM - 8 IN^{1/16}



002185
FOURCHETTE
DE SERVICE
SERVING FORK
24,8 CM - 9 IN^{3/4}



126096
COUTEAU À DESSERT
MANCHE ORFÈVRE LAME UNIE
DESSERT KNIFE HOLLOW HANDLE
20,5 CM - 8 IN^{1/16}



002186
CUILLÈRE
DE SERVICE
SERVING SPOON
25 CM - 9 IN^{13/16}



190417
COUTEAU À BEURRE
MONOBLOC LOURD LAME UNIE
BUTTER KNIFE HEAVY SOLID HANDLE
18,7 CM - 7 IN^{3/8}



040646
SERVICE
À SALADE
SALADE SERVING SET
25,8 CM - 10 IN^{3/16}



129344
COUTEAU À BEURRE
MANCHE ORFÈVRE
LAME UNIE
BUTTER KNIFE HOLLOW
HANDLE
18,7 CM - 7 IN^{3/8}



083340
PELLE À TARTE
MONOBLOC
PASTRY SERVER
SOLID HANDLE
24,9 CM - 9 IN^{13/16}



097717
LOUCHE
SOUP LADLE
29,8 CM - 11 IN^{3/4}



002179
LOUCHE À SAUCE
SAUCE LADLE
15,7 CM - 6 IN^{3/16}

ÉGALEMENT DISPONIBLE EN MÉTAL ARGENTÉ
ALSO AVAILABLE IN SILVERPLATED FINISH



Possibilité de personnalisation
Bespoke options available

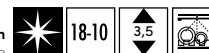

FLORENCIA

Finedining





**105021
FOURCHETTE DE TABLE**
TABLE FORK
20,9 CM - 8 IN^{3/16}



**190415
COUTEAU DE TABLE
MONOBLOC LOURD LAME SCIE**
TABLE KNIFE HEAVY SOLID HANDLE SERRATED
24,8 CM - 9 IN^{3/4}



**105006
COUTEAU DE TABLE
MANCHE ORFÈVRE LAME SCIE**
TABLE KNIFE HOLLOW HANDLE SERRATED
24,7 CM - 9 IN^{3/4}



**122746
COUTEAU À STEAK
MANCHE ORFÈVRE LAME SCIE**
STEAK KNIFE HOLLOW HANDLE SERRATED
23,8 CM - 9 IN^{3/8}



**190414
COUTEAU À BEURRE
MONOBLOC LOURD
LAME UNIE**
BUTTER KNIFE HEAVY SOLID HANDLE
19,7 CM - 7 IN^{3/4}



**016394
COUTEAU À BEURRE
MANCHE ORFÈVRE LAME UNIE**
BUTTER KNIFE HOLLOW HANDLE
18,9 CM - 7 IN^{7/16}



**104994
FOURCHETTE À POISSON**
FISH FORK
17,9 CM - 7 IN^{1/16}



**104995
COUTEAU À POISSON**
FISH KNIFE
20 CM - 7 IN^{7/8}



**104988
CUIILLÈRE DE TABLE**
TABLE/PASTA SPOON
21,1 CM - 8 IN^{5/16}



**104986
CUIILLÈRE À CAFÉ**
COFFEE/TEA SPOON
14,1 CM - 5 IN^{9/16}



**104975
CUIILLÈRE À SOUPE ANGLAISE**
BOUILLON SPOON, ROUND
17,4 CM - 6 IN^{7/8}



**104993
CUIILLÈRE À MOKA**
DEMI TASSE SPOON
11,2 CM - 4 IN^{7/16}



**104985
CUIILLÈRE À DESSERT**
DESSERT/SOUP SPOON, OVAL
18 CM - 7 IN^{1/16}



**105012
FOURCHETTE À GÂTEAUX/
COCKTAIL**
PASTRY/COCKTAIL FORK
13,9 CM - 5 IN^{1/2}



**105013
FOURCHETTE À DESSERT**
DESSERT/SALAD FORK
17,9 CM - 7 IN^{1/16}



**190416
COUTEAU À DESSERT
MONOBLOC LOURD LAME UNIE**
DESSERT KNIFE HEAVY SOLID HANDLE
21,3 CM - 8 IN^{3/8}



**104989
COUTEAU À DESSERT
MANCHE ORFÈVRE LAME UNIE**
DESSERT KNIFE HOLLOW HANDLE
20,6 CM - 8 IN^{1/8}

EGALEMENT DISPONIBLE EN MÉTAL ARGENTÉ
ALSO AVAILABLE IN SILVERPLATED FINISH



Possibilité de personnalisation
Bespoke options available

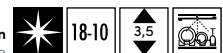

LUTÈCE

Finedining



MADE IN FRANCE



L'abus d'alcool est dangereux pour la santé
Alcohol abuse is dangerous for your health



182968
FOURCHETTE DE TABLE
TABLE FORK
20,8 CM - 8 IN^{3/16}



182972
FOURCHETTE À POISSON
FISH FORK
17,7 CM - 6 IN^{15/16}



182970
COUTEAU DE TABLE
MANCHE ORFÈVRE LAME SCIE
TABLE KNIFE HOLLOW HANDLE SERRATED
24,6 CM - 9 IN^{11/16}



182973
COUTEAU À POISSON
FISH KNIFE
19,9 CM - 7 IN^{13/16}



186278
COUTEAU À STEAK
MANCHE ORFÈVRE LAME SCIE
STEAK KNIFE HOLLOW HANDLE SERRATED
23,9 CM - 9 IN^{7/16}



182969
CUILLÈRE À CAFÉ
COFFEE/TEA SPOON
14 CM - 5 IN^{1/2}



182967
CUILLÈRE DE TABLE
TABLE/PASTA SPOON
20,8 CM - 8 IN^{3/16}



182976
CUILLÈRE À MOKA
DEMI TASSE SPOON
11 CM - 4 IN^{5/16}



186276
CUILLÈRE À SOUPE ANGLAISE
BOUILLON SPOON, ROUND
17,4 CM - 6 IN^{7/8}



186274
FOURCHETTE À GÂTEAUX/
COCKTAIL
PASTRY/COCKTAIL FORK
13,8 CM - 5 IN^{7/16}



182974
CUILLÈRE À DESSERT
DESSERT/SOUP SPOON, OVAL
18 CM - 7 IN^{1/16}



190681
FOURCHETTE À HUITRES
OYSTER FORK
13 CM - 5 IN^{1/8}



182975
FOURCHETTE À DESSERT
DESSERT/SALAD FORK
17,8 CM - 7 IN



182971
COUTEAU À DESSERT
MANCHE ORFÈVRE LAME UNIE
DESSERT KNIFE HOLLOW HANDLE
20,5 CM - 8 IN^{1/16}

SUGGESTION PIÈCES DE SERVICE
SUGGESTED SERVING PIECES
VERLAINE



186279
COUTEAU À BEURRE
MANCHE ORFÈVRE LAME UNIE
BUTTER KNIFE HOLLOW HANDLE
18,7 CM - 7 IN^{3/8}



002185
FOURCHETTE
DE SERVICE
SERVING FORK
24,8 CM - 9 IN^{3/4}



002186
CUILLÈRE
DE SERVICE
SERVING SPOON
25 CM - 9 IN^{13/16}



040646
SERVICE
À SALADE
SALADE SERVING SET
25,8 CM - 10 IN^{3/16}



083340
PELLE À TARTE
MONOBLOC
PASTRY SERVER
SOLID HANDLE
24,9 CM - 9 IN^{13/16}



097717
LOUCHE
SOUP LADLE
29,8 CM - 11 IN^{3/4}



002179
LOUCHE À SAUCE
SAUCE LADLE
15,7 CM - 6 IN^{3/16}

ÉGALEMENT DISPONIBLE EN MÉTAL ARGENTÉ
ALSO AVAILABLE IN SILVERPLATED FINISH



Possibilité de personnalisation
Bespoke options available

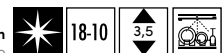

MARQUISE

Finedining

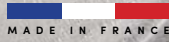

MADE IN FRANCE





141089
FOURCHETTE DE TABLE
TABLE FORK
20,3 CM - 8 IN



103550
CUILLÈRE À CAFÉ
COFFEE/TEA SPOON
13,5 CM - 5 IN^{5/16}



113017
COUTEAU DE TABLE
MONOBLOC LAME SCIE
TABLE KNIFE SOLID HANDLE
SERRATED
24,4 CM - 9 IN^{5/8}



109465
CUILLÈRE À MOKA
DEMI TASSE SPOON
11 CM - 4 IN^{5/16}



160427
COUTEAU À STEAK
MONOBLOC LAME SCIE
STEAK KNIFE SOLID HANDLE
SERRATED
23,2 CM - 9 IN^{1/8}

SUGGESTION PIÈCES DE SERVICE
SUGGESTED SERVING PIECES
BLOIS



124259
CUILLÈRE À SODA
ICED TEA SPOON
18,2 CM - 7 IN^{3/16}



141086
CUILLÈRE DE TABLE
TABLE/PASTA SPOON
20,4 CM - 8 IN^{1/16}



104480
FOURCHETTE À GÂTEAUX/
COCKTAIL
PASTRY/COCKTAIL FORK
13,8 CM - 5 IN^{7/16}



104448
CUILLÈRE À SOUPE ANGLAISE
BLOIS
BOUILLON SPOON, ROUND
17,2 CM - 6 IN^{3/4}



104463
FOURCHETTE À HUÎTRES
OYSTER FORK
13 CM - 5 IN^{1/8}



108236
CUILLÈRE À DESSERT
DESSERT/SOUP SPOON, OVAL
17,9 CM - 7 IN^{17/16}



195757
FOURCHETTE DE SERVICE
SERVING FORK
24,8 CM - 9 IN^{3/4}



108238
FOURCHETTE À DESSERT
DESSERT/SALAD FORK
17,8 CM - 7 IN



195755
CUILLÈRE DE SERVICE
SERVING SPOON
25 CM - 9 IN^{13/16}



113019
COUTEAU À DESSERT
MONOBLOC LAME UNIE
DESSERT KNIFE SOLID HANDLE
21 CM - 8 IN^{1/4}



195750
SERVICE À SALADE
SALAD SERVING SET
25,7 CM - 10 IN^{1/8}



189971
COUTEAU À BEURRE
MONOBLOC LAME UNIE
GOUTTE
BUTTER KNIFE SOLID HANDLE
18,8 CM - 7 IN^{3/8}



195753
PELLE À TARTE MONOBLOC
PASTRY SERVER SOLID HANDLE
24,9 CM - 9 IN^{13/16}



104507
FOURCHETTE POISSON
BLOIS
FISH FORK
17,7 CM - 6 IN^{15/16}



195762
LOUCHE
SOUP LADLE
29,8 CM - 11 IN^{3/4}



104508
COUTEAU POISSON
BLOIS
FISH KNIFE
19,9 CM - 7 IN^{13/16}



195759
LOUCHE À SAUCE
SAUCE LADLE
15,7 CM - 6 IN^{3/16}

EGALEMENT DISPONIBLE EN MÉTAL ARGENTÉ
ALSO AVAILABLE IN SILVERPLATED FINISH



Possibilité de personnalisation
Bespoke options available

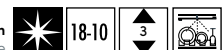

MIKADO

Alldaydining





230285
FOURCHETTE DE TABLE
 TABLE FORK
 20,3 CM - 8 IN



230287
COUTEAU DE TABLE
MONOBLOC LAME SCIE
 TABLE KNIFE SOLID HANDLE SERRATED
 24,4 CM - 9 IN^{5/8}



230293
COUTEAU À STEAK
MONOBLOC LAME SCIE
 STEAK KNIFE SOLID HANDLE SERRATED
 23,2 CM - 9 IN^{1/8}



230286
CUILLÈRE DE TABLE
 TABLE/PASTA SPOON
 20,4 CM - 8 IN^{1/16}



230291
CUILLÈRE À DESSERT
 DESSERT/SOUP SPOON, OVAL
 17,9 CM - 7 IN^{1/16}



230290
FOURCHETTE À DESSERT
 DESSERT/SALAD FORK
 17,8 CM - 7 IN



230292
COUTEAU À DESSERT
MONOBLOC LOURD LAME UNIE
 DESSERT KNIFE HEAVY SOLID HANDLE
 21 CM - 8 IN^{1/4}



230288
CUILLÈRE À CAFÉ
 COFFEE/TEA SPOON
 13,5 CM - 5 IN^{5/16}



230289
CUILLÈRE À MOKA
 DEMI TASSE SPOON
 11 CM - 4 IN^{5/16}

MIKADO VINTAGE

All day dining





127442
FOURCHETTE DE TABLE
TABLE FORK
20,8 CM - 8 IN^{3/16}



226578
COUTEAU DE TABLE
MONOBLOC LOURD LAME SCIE
TABLE KNIFE HEAVY SOLID HANDLE SERRATED
24,4 CM - 9 IN^{5/8}



139158
COUTEAU DE TABLE
MANCHE ORFÈVRE LAME SCIE
TABLE KNIFE HOLLOW HANDLE SERRATED
24,6 CM - 9 IN^{1/16}



128841
COUTEAU À STEAK
MANCHE ORFÈVRE LAME SCIE
STEAK KNIFE HOLLOW HANDLE SERRATED
23,9 CM - 9 IN^{7/16}



127439
CUILLÈRE DE TABLE
TABLE/PASTA SPOON
20,8 CM - 8 IN^{3/16}



127464
CUILLÈRE À DESSERT
DESSERT/SOUP SPOON, OVAL
18 CM - 7 IN^{1/16}



127467
FOURCHETTE À DESSERT
DESSERT/SALAD FORK
17,8 CM - 7 IN



226579
COUTEAU À DESSERT
MONOBLOC LOURD LAME UNIE
DESSERT KNIFE HEAVY SOLID HANDLE
21,1 CM - 8 IN^{5/16}



127470
COUTEAU À DESSERT
MANCHE ORFÈVRE LAME UNIE
DESSERT KNIFE HOLLOW HANDLE
20,5 CM - 8 IN^{1/16}



226580
COUTEAU À BEURRE
MONOBLOC LOURD LAME UNIE
BUTTER KNIFE HEAVY SOLID HANDLE
19 CM - 7 IN^{1/2}



122769
COUTEAU À BEURRE
MANCHE ORFÈVRE LAME UNIE
BUTTER KNIFE HOLLOW HANDLE
18,7 CM - 7 IN^{3/8}



127473
FOURCHETTE À POISSON
FISH FORK
17,7 CM - 6 IN^{15/16}



127477
COUTEAU À POISSON
FISH KNIFE
19,9 CM - 7 IN^{13/16}



130542
CUILLÈRE À SAUCE GOURMET
GOURMET/SAUCE SPOON
17,9 CM - 7 IN^{1/16}



127455
CUILLÈRE À CAFÉ
COFFEE/TEA SPOON
14 CM - 5 IN^{1/2}



127479
CUILLÈRE À MOKA
DEMI TASSE SPOON
11 CM - 4 IN^{5/16}



127482
FOURCHETTE À GÂTEAUX/
COCKTAIL
PASTRY/COCKTAIL FORK
13,8 CM - 5 IN^{7/16}



130266
FOURCHETTE À HUÎTRES
OYSTER FORK
13 CM - 5 IN^{1/8}

SUGGESTION PIÈCES DE SERVICE
SUGGESTED SERVING PIECES
VERLAINE



002185
FOURCHETTE
DE SERVICE
SERVING FORK
24,8 CM - 9 IN^{3/4}



002186
CUILLÈRE
DE SERVICE
SERVING SPOON
25 CM - 9 IN^{13/16}



040646
SERVICE
À SALADE
SALADE SERVING SET
25,8 CM - 10 IN^{3/16}



083340
PELLE À TARTE
MONOBLOC
PASTRY SERVER
SOLID HANDLE
24,9 CM - 9 IN^{13/16}



097717
LOUCHE
SOUP LADLE
29,8 CM - 11 IN^{3/4}



002179
LOUCHE À SAUCE
SAUCE LADLE
15,7 CM - 6 IN^{3/16}

ÉGALEMENT DISPONIBLE EN MÉTAL ARGENTÉ
ALSO AVAILABLE IN SILVERPLATED FINISH



Possibilité de personnalisation
Bespoke options available

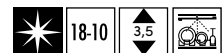

MILADY

Finedining

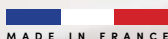

MADE IN FRANCE





**105278
FOURCHETTE DE TABLE**
TABLE FORK
20,8 CM - 8 IN^{3/16}



**105274
COUTEAU DE TABLE
MANCHE ORFÈVRE LAME SCIE**
TABLE KNIFE HOLLOW HANDLE SERRATED
24,6 CM - 9 IN^{1/16}



**105310
CUILLÈRE DE TABLE**
TABLE/PASTA SPOON
20,8 CM - 8 IN^{3/16}



**105294
CUILLÈRE À DESSERT**
DESSERT/SOUP SPOON, OVAL
CUCHARA DE POSTRE
18 CM - 7 IN^{1/16}



**105290
FOURCHETTE À DESSERT**
DESSERT/SALAD FORK
17,8 CM - 7 IN



**105305
COUTEAU À DESSERT
MANCHE ORFÈVRE LAME UNIE**
DESSERT KNIFE HOLLOW HANDLE
20,5 CM - 8 IN^{1/16}



**105303
CUILLÈRE À CAFÉ**
COFFEE/TEA SPOON
14 CM - 5 IN^{1/2}



**105293
CUILLÈRE À MOKA**
DEMI TASSE SPOON
11 CM - 4 IN^{5/16}

SUGGESTION PIÈCES DE SERVICE
SUGGESTED SERVING PIECES
VERLAINE



**002185
FOURCHETTE DE SERVICE**
SERVING FORK
24,8 CM - 9 IN^{3/4}



**002186
CUILLÈRE DE SERVICE**
SERVING SPOON
25 CM - 9 IN^{3/16}



**040646
SERVICE À SALADE**
SALADE SERVING SET
25,8 CM - 10 IN^{3/16}



**083340
PELLE À TARTE MONOBLOC**
PASTRY SERVER
SOLID HANDLE
24,9 CM - 9 IN^{13/16}



**097717
LOUCHE**
SOUP LADLE
29,8 CM - 11 IN^{3/4}



**002179
LOUCHE À SAUCE**
SAUCE LADLE
15,7 CM - 6 IN^{3/16}

ÉGALEMENT DISPONIBLE EN MÉTAL ARGENTÉ
ALSO AVAILABLE IN SILVERPLATED FINISH



Possibilité de personnalisation
Bespoke options available



NEUILLY

Finedining



MADE IN FRANCE





232963
FOURCHETTE DE TABLE
TABLE FORK
20,3 CM - 8 IN



232966
COUTEAU DE TABLE
MONOBLOC LAME SCIE
TABLE KNIFE SOLID HANDLE SERRATED
24 CM - 9 IN^{7/16}



232964
CUILLÈRE DE TABLE
TABLE/PASTA SPOON
20,3 CM - 8 IN



234654
CUILLÈRE À SOUPE ANGLAISE
BOUILLON SPOON
17,6 CM - 6 IN^{15/16}



234659
CUILLÈRE À DESSERT
DESSERT/SOUP SPOON, OVAL
18,2 CM - 7 IN^{3/16}



234655
CUILLÈRE GOURMET
GOURMET SPOON
18,2 CM - 7 IN^{3/16}



234656
FOURCHETTE À DESSERT/POISSON
DESSERT/SALAD/FISH FORK
18,3 CM - 7 IN^{3/16}



239036
COUTEAU À POISSON/SPATULE GOURMET
MONOBLOC LAME UNIE
FISH KNIFE/GOURMET SPATULA
21,5 CM - 8 IN^{7/16}



234657
COUTEAU À DESSERT
MONOBLOC LAME UNIE
DESSERT KNIFE SOLID HANDLE
21,5 CM - 8 IN^{7/16}



234658
COUTEAU À BEURRE
MONOBLOC LAME UNIE
BUTTER KNIFE SOLID HANDLE
18,5 CM - 7 IN^{5/16}



232965
CUILLÈRE À CAFÉ
COFFEE/TEA SPOON
14 CM - 5 IN^{1/2}



234660
CUILLÈRE À MOKA
DEMI TASSE SPOON
11,1 CM - 4 IN^{3/8}



234661
FOURCHETTE À GÂTEAUX/COCKTAIL
PASTRY/COCKTAIL FORK
14 CM - 5 IN^{1/2}

EGALEMENT DISPONIBLE EN MÉTAL ARGENTÉ
ALSO AVAILABLE IN SILVERPLATED FINISH



Possibilité de personnalisation
Bespoke options available



NORMANDY

Finedining





204524
FOURCHETTE DE TABLE
TABLE FORK
20,2 CM - 7 IN^{5/16}



246567
COUTEAU DE TABLE
MONOBLOC LAME SCIE
TABLE KNIFE SOLID HANDLE SERRATED
24,4 CM - 9 IN^{5/8}



204523
CUILLÈRE DE TABLE
TABLE/PASTA SPOON
20,2 CM - 7 IN^{5/16}



209268
CUILLÈRE À DESSERT
DESSERT/SOUP SPOON, OVAL
17,9 CM - 7 IN^{1/8}



209267
FOURCHETTE À DESSERT
DESSERT FORK
17,8 CM - 7 IN



246568
COUTEAU À DESSERT
MONOBLOC LAME UNIE
DESSERT KNIFE SOLID HANDLE
21 CM - 8 IN^{1/4}



204525
CUILLÈRE À CAFÉ
COFFEE/TEA SPOON
13,5 CM - 5 IN^{5/16}

EGALEMENT DISPONIBLE EN MÉTAL ARGENTÉ
ALSO AVAILABLE IN SILVERPLATED FINISH



Possibilité de personnalisation
Bespoke options available



SWELL

Alldaydining



NEW





105831
FOURCHETTE DE TABLE
TABLE FORK
20,8 CM - 8 IN^{3/16}



182460
COUTEAU DE TABLE
MONOBLOC LOURD LAME SCIE
TABLE KNIFE HEAVY SOLID HANDLE
SERRATED
24,6 CM - 9 IN^{1/16}



105886
COUTEAU DE TABLE
MANCHE ORFÈVRE LAME UNIE
TABLE KNIFE HOLLOW HANDLE
24,6 CM - 9 IN^{1/16}



105860
COUTEAU DE TABLE
MANCHE ORFÈVRE LAME SCIE
TABLE KNIFE HOLLOW HANDLE SERRATED
24,6 CM - 9 IN^{1/16}



105801
COUTEAU À STEAK
MANCHE ORFÈVRE LAME SCIE
STEAK KNIFE HOLLOW HANDLE SERRATED
23,9 CM - 9 IN^{7/16}



105798
CUILLÈRE DE TABLE
TABLE/PASTA SPOON
20,8 CM - 8 IN^{3/16}



105908
CUILLÈRE À SOUPE ANGLAISE
BOUILLON SPOON, ROUND
17,2 CM - 6 IN^{3/4}



105861
CUILLÈRE À DESSERT
DESSERT/SOUP SPOON, OVAL
18 CM - 7 IN^{1/16}



105885
FOURCHETTE À DESSERT
DESSERT/SALAD FORK
17,8 CM - 7 IN



182463
COUTEAU À DESSERT
MONOBLOC LOURD LAME UNIE
DESSERT KNIFE HEAVY SOLID HANDLE
20,5 CM - 8 IN^{1/16}



105832
COUTEAU À DESSERT
MANCHE ORFÈVRE
LAME UNIE
DESSERT KNIFE HOLLOW HANDLE
20,5 CM - 8 IN^{1/16}



190420
COUTEAU À BEURRE
MONOBLOC LOURD
LAME UNIE
BUTTER KNIFE HEAVY SOLID HANDLE
19 CM - 7 IN^{1/2}



003332
COUTEAU À BEURRE
MANCHE ORFÈVRE
LAME UNIE
BUTTER KNIFE HOLLOW HANDLE
18,7 CM - 7 IN^{3/8}



105888
FOURCHETTE À POISSON
FISH FORK
17,8 CM - 7 IN



105797
COUTEAU À POISSON
FISH KNIFE
19,7 CM - 7 IN^{3/4}



105910
CUILLÈRE À SAUCE GOURMET
GOURMET/SAUCE SPOON
17,9 CM - 7 IN^{1/16}



105833
CUILLÈRE À CAFÉ
COFFEE/TEA SPOON
14 CM - 5 IN^{1/2}



109471
CUILLÈRE À MOKA
CONFIDENCE
DEMI TASSE SPOON
11 CM - 4 IN^{5/16}



105800
CUILLÈRE À SODA
ICED TEA SPOON
18,2 CM - 7 IN^{3/16}



105795
FOURCHETTE À GÂTEAUX/
COCKTAIL
PASTRY/COCKTAIL FORK
13,8 CM - 5 IN^{7/16}



105907
FOURCHETTE À HUÎTRES
OYSTER FORK
12,9 CM - 5 IN^{1/16}



132782
FOURCHETTE À ESCARGOTS
CONFIDENCE
SNAIL FORK
13,5 CM - 5 IN^{5/16}



003390
COUTEAU À FROMAGES
MANCHE ORFÈVRE LAME UNIE
CHEESE KNIFE HOLLOW HANDLE
19,3 CM - 7 IN^{5/8}



002185
FOURCHETTE DE SERVICE
SERVING FORK
24,8 CM - 9 IN^{3/4}



002186
CUILLÈRE DE SERVICE
SERVING SPOON
25 CM - 9 IN^{13/16}



040646
SERVICE À SALADE
SALADE SERVING SET
25,8 CM - 10 IN^{3/16}



083340
PELLE À TARTE MONOBLOC
PASTRY SERVER SOLID HANDLE
24,9 CM - 9 IN^{13/16}



097717
LOUCHE
SOUP LADLE
29,8 CM - 11 IN^{3/4}



002179
LOUCHE À SAUCE
SAUCE LADLE
15,7 CM - 6 IN^{3/16}

ÉGALEMENT DISPONIBLE EN MÉTAL ARGENTÉ
ALSO AVAILABLE IN SILVERPLATED FINISH



Possibilité de personnalisation
Bespoke options available



VERLAINE

Finedining

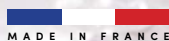

MADE IN FRANCE





105804
FOURCHETTE DE TABLE
TABLE FORK
21 CM - 8 IN^{1/4}



105892
COUTEAU DE TABLE
MONOBLOC LAME SCIE
TABLE KNIFE SOLID HANDLE
SERRATED
25 CM - 9 IN^{13/16}



160424
COUTEAU À STEAK
MONOBLOC LAME SCIE
STEAK KNIFE SOLID HANDLE SERRATED
23,2 CM - 9 IN^{1/8}



105911
CUILLÈRE DE TABLE
TABLE/PASTA SPOON
21 CM - 8 IN^{1/4}



105863
CUILLÈRE À DESSERT
DESSERT/SOUP SPOON, OVAL
18 CM - 7 IN^{1/16}



105890
FOURCHETTE À DESSERT
DESSERT/SALAD FORK
18 CM - 7 IN^{1/16}



210626
COUTEAU À DESSERT
MONOBLOC LAME SCIE
DESSERT KNIFE SOLID HANDLE SERRATED
20,7 CM - 8 IN^{1/8}



105837
FOURCHETTE À POISSON
FISH FORK
18 CM - 7 IN^{1/16}



105912
COUTEAU À POISSON
FISH KNIFE
20 CM - 7 IN^{7/8}



105838
CUILLÈRE À CAFÉ
COFFEE/TEA SPOON
14,1 CM - 5 IN^{9/16}



105891
CUILLÈRE À MOKA
DEMI TASSE SPOON
11 CM - 4 IN^{5/16}



105805
FOURCHETTE À GÂTEAUX/
COCKTAIL
PASTRY/COCKTAIL FORK
13,9 CM - 5 IN^{1/2}



105803
FOURCHETTE À HÙITRES
OYSTER FORK
13,2 CM - 5 IN^{3/16}



000490
FOURCHETTE DE SERVICE
SERVING FORK
24,6 CM - 9 IN^{11/16}



000491
CUILLÈRE DE SERVICE
SERVING SPOON
24,9 CM - 9 IN^{12/16}

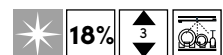

VIEUX PARIS

Alldaydining





LE COUVERT DESIGN
Design Flatware



126355
FOURCHETTE DE TABLE
TABLE FORK
20,1 CM - 7 IN^{15/16}



126358
CUILLÈRE À CAFÉ
COFFEE/TEA SPOON
13,7 CM - 5 IN^{3/8}



210731
COUTEAU DE TABLE
MONOBLOC LAME SCIE
TABLE KNIFE SOLID HANDLE SERRATED
23,5 CM - 9 IN^{1/4}



140852
CUILLÈRE À MOKA
DEMI TASSE SPOON
11 CM - 4 IN^{5/16}



126352
CUILLÈRE DE TABLE
TABLE/PASTA SPOON
20,3 CM - 8 IN



189973
CUILLÈRE À SODA
GOUTTE
ICED TEA SPOON
19 CM - 7 IN^{1/2}



140855
CUILLÈRE À SOUPE ANGLAISE
BOUILLON SPOON, ROUND
17,9 CM - 7 IN^{1/8}



126383
FOURCHETTE À GÂTEAUX
COCKTAIL
PASTRY/COCKTAIL FORK
13,7 CM - 5 IN^{3/8}



126368
CUILLÈRE À DESSERT
DESSERT/SOUP SPOON, OVAL
17,8 CM - 7 IN



189974
FOURCHETTE À HÛÎTRES
GOUTTE
OYSTER FORK
14,1 CM - 5 IN^{11/16}



126371
FOURCHETTE À DESSERT
DESSERT/SALAD FORK
17,7 CM - 6 IN^{15/16}



231218
FOURCHETTE DE SERVICE
GOUTTE
SERVING FORK
26,6 CM - 10 IN^{1/2}



210732
COUTEAU À DESSERT
MONOBLOC LAME UNIE
DESSERT KNIFE SOLID HANDLE
20,7 CM - 8 IN^{1/8}



231219
CUILLÈRE DE SERVICE
GOUTTE
SERVING SPOON
26,6 CM - 10 IN^{1/2}



189971
COUTEAU À BEURRE
MONOBLOC LAME UNIE
GOUTTE
BUTTER KNIFE SOLID HANDLE
18,8 CM - 7 IN^{3/8}



231221
PELLE À TARTE MONOBLOC
GOUTTE
PASTRY SERVER SOLID HANDLE
25,2 CM - 9 IN^{15/16}



126377
FOURCHETTE À POISSON
FISH FORK
17,7 CM - 6 IN^{15/16}



231220
LOUCHE
GOUTTE
SOUP LADLE
29 CM - 11 IN^{7/16}



181181
COUTEAU À POISSON/
GOURMET
GOURMET FISH KNIFE
20,1 CM - 7 IN^{15/16}

EGALEMENT DISPONIBLE EN MÉTAL ARGENTÉ
ALSO AVAILABLE IN SILVERPLATED FINISH



Possibilité de personnalisation
Bespoke options available



AQUATIC

Finedining



MADE IN FRANCE





153998
FOURCHETTE DE TABLE
TABLE FORK
20,7 CM - 8 IN^{1/8}



154002
COUTEAU DE TABLE MONOBLOC LAME SCIE
TABLE KNIFE SOLID HANDLE SERRATED
23,5 CM - 9 IN^{1/4}



199761
COUTEAU À STEAK
STEAK TABLE
22,8 CM - 9 IN



153996
CUILLÈRE DE TABLE
TABLE/PASTA SPOON
20,7 CM - 8 IN^{7/8}



190015
CUILLÈRE À SOUPE ANGLAISE
BOUILLON SPOON, ROUND
18,3 CM - 7 IN^{3/16}



154571
CUILLÈRE À DESSERT
DESSERT/SOUP SPOON, OVAL
18,6 CM - 7 IN^{5/16}



154574
FOURCHETTE À DESSERT
DESSERT/SALAD FORK
18,6 CM - 7 IN^{5/16}



154555
COUTEAU À DESSERT MONOBLOC LAME SCIE
DESSERT KNIFE SOLID HANDLE SERRATED
21,1 CM - 8 IN^{5/16}



154580
COUTEAU À BEURRE MONOBLOC LAME UNIE
BUTTER KNIFE SOLID HANDLE
19,4 CM - 7 IN^{5/8}



154558
FOURCHETTE À POISSON
FISH FORK
18,7 CM - 7 IN^{3/8}



154561
COUTEAU À POISSON/ GOURMET
GOURMET FISH KNIFE
21,1 CM - 8 IN^{5/16}



154001
CUILLÈRE À CAFÉ
COFFEE/TEA SPOON
14,1 CM - 5 IN^{3/16}



154577
CUILLÈRE À MOKA
DEMI TASSE SPOON
11,1 CM - 4 IN^{3/8}



190016
CUILLÈRE À SODA
ICED TEA SPOON
19 CM - 7 IN^{1/2}



154547
FOURCHETTE À GÂTEAUX COCKTAIL
PASTRY/COCKTAIL FORK
14 CM - 5 IN^{1/2}



154563
FOURCHETTE DE SERVICE
SERVING FORK
25,1 CM - 9 IN^{7/8}



154562
CUILLÈRE DE SERVICE
SERVING SPOON
25,5 CM - 10 IN^{1/16}



154566
SERVICE À SALADE
SALAD SERVING SET
24,3 CM - 9 IN^{3/16}



154552
PELLE À TARTE MONOBLOC
PASTRY SERVER SOLID HANDLE
25,3 CM - 9 IN^{15/16}



154550
LOUCHE
SOUP LADLE
29,7 CM - 11 IN^{11/16}

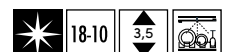

ASTRÉE CISELÉ

Alldaydining





239410
FOURCHETTE DE TABLE
 TABLE FORK
 20,1 CM - 7 IN^{5/16}



239411
COUTEAU DE TABLE
MANCHE ORFÈVRE LAME UNIE
 HOLLOW HANDLE TABLE KNIFE
 23,5 CM - 9 IN^{1/4}



239412
CUILLÈRE DE TABLE
 TABLE/PASTA SPOON
 20,3 CM - 8 IN



239416
CUILLÈRE À DESSERT
 DESSERT/SOUP SPOON, OVAL
 17,8 CM - 7 IN



239414
FOURCHETTE À DESSERT
 DESSERT/SALAD FORK
 17,7 CM - 6 IN^{5/16}



239415
COUTEAU À DESSERT
MANCHE ORFÈVRE LAME UNIE
 DESSERT KNIFE HOLLOW HANDLE
 20,7 CM - 8 IN^{1/8}



239418
FOURCHETTE À POISSON
 FISH FORK
 17,7 CM - 6 IN^{5/16}



239419
COUTEAU À POISSON/
GOURMET
 GOURMET FISH KNIFE
 20,3 CM - 8 IN



239413
CUILLÈRE À CAFÉ
 COFFEE/TEA SPOON
 13,7 CM - 5 IN^{3/8}



239417
CUILLÈRE À MOKA
 COFFEE/TEA SPOON
 11 CM - 4 IN^{5/16}

EGALEMENT DISPONIBLE EN MÉTAL ARGENTÉ
 ALSO AVAILABLE IN SILVERPLATED FINISH

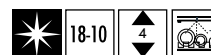

COUTURE

Finedining





236700
FOURCHETTE DE TABLE
 TABLE FORK
 21,5 CM - 8 IN^{7/16}



236702
COUPEAU DE TABLE
MONOBLOC LAME SCIE
 TABLE KNIFE SOLID HANDLE SERRATED
 21,5 CM - 8 IN^{7/16}



111970
COUPEAU DE TABLE
MONOBLOC LAME SCIE
OVATION
 TABLE KNIFE SOLID HANDLE SERRATED
 23 CM - 9 IN^{1/16}



236701
CUILLÈRE DE TABLE
 TABLE/PASTA SPOON
 21,5 CM - 8 IN^{7/16}



236726
CUILLÈRE À SOUPE ANGLAISE
 BOUILLON SPOON, ROUND
 18,5 CM - 7 IN^{5/16}



236721
CUILLÈRE À DESSERT
 DESSERT/SOUP SPOON, OVAL
 19,1 CM - 7 IN^{1/2}



236719
FOURCHETTE À DESSERT
 DESSERT/SALAD FORK
 19,1 CM - 7 IN^{1/2}



236720
COUPEAU À DESSERT
MONOBLOC LAME UNIE
 DESSERT KNIFE SOLID HANDLE
 19,2 CM - 7 IN^{9/16}



236727
TARTINEUR
 BUTTER SPREADER
 16,5 CM - 6 IN^{1/2}



181112
TARTINEUR
XY
 BUTTER SPREADER
 16 CM - 6 IN^{5/16}



236703
CUILLÈRE À CAFÉ
 COFFEE/TEA SPOON
 15 CM - 5 IN^{7/8}



236722
CUILLÈRE À MOKA
 DEMI TASSE SPOON
 11 CM - 4 IN^{5/16}



236724
FOURCHETTE DE SERVICE
 SERVING FORK
 26 CM - 10 IN^{1/4}



236723
CUILLÈRE DE SERVICE
 SERVING SPOON
 26 CM - 10 IN^{1/4}

EGALEMENT DISPONIBLE EN MÉTAL ARGENTÉ
 ALSO AVAILABLE IN SILVERPLATED FINISH



Possibilité de personnalisation
 Bespoke options available



FUSE MIROIR

Alldaydining



FUSE MARTELÉ HAMMERED



236790
FOURCHETTE DE TABLE
TABLE FORK
21,5 CM - 8 IN^{7/16}



236791
COUTEAU DE TABLE
MONOBLOC LAME SCIE
TABLE KNIFE SOLID HANDLE SERRATED
21,5 CM - 8 IN^{7/16}



236789
CUILLÈRE DE TABLE
TABLE/PASTA SPOON
21,5 CM - 8 IN^{7/16}



236802
CUILLÈRE À SOUPE ANGLAISE
BOUILLON SPOON, ROUND
18,5 CM - 7 IN^{5/16}



236796
CUILLÈRE À DESSERT
DESSERT/SOUP SPOON, OVAL
19,1 CM - 7 IN^{1/2}



236794
FOURCHETTE À DESSERT
DESSERT/SALAD FORK
19,1 CM - 7 IN^{1/2}



236795
COUTEAU À DESSERT
MONOBLOC LAME UNIE
DESSERT KNIFE SOLID HANDLE
19,2 CM - 7 IN^{3/16}



236804
TARTINEUR
BUTTER SPREADER
16,5 CM - 6 IN^{1/2}



236798
CUILLÈRE À CAFÉ
COFFEE/TEA SPOON
15 CM - 5 IN^{7/8}



236797
CUILLÈRE À MOKA
DEMI TASSE SPOON
11 CM - 4 IN^{5/16}



236806
PIC APÉRO/ESCARGOTS
COCKTAIL /SNAIL PICK
15 CM - 5 IN^{7/8}



236805
FOURCHETTE/GÂTEAUX
ESCARGOTS/COCKTAIL
CAKE/COCKTAIL FORK
15 CM - 5 IN^{7/8}



236800
FOURCHETTE DE SERVICE
SERVING FORK
26 CM - 10 IN^{1/4}



236799
CUILLÈRE DE SERVICE
SERVING SPOON
26 CM - 10 IN^{1/4}

Possibilité de personnalisation
Bespoke options available



FUSE MARTELÉ

Alldaydining



197507
FOURCHETTE DE TABLE
TABLE FORK
21,3 CM - 8 IN^{3/8}



197509
COUTEAU DE TABLE
MONOBLOC LAME SCIE
TABLE KNIFE SOLID HANDLE SERRATED
23,2 CM - 9 IN^{3/8}



235481
COUTEAU DE TABLE
MONOBLOC LAME SCIE
TABLE KNIFE SOLID HANDLE SERRATED
23,7 CM - 9 IN^{5/16}



197521
COUTEAU À STEAK
MONOBLOC LAME SCIE
STEAK KNIFE SOLID HANDLE SERRATED
23,2 CM - 9 IN^{3/8}



197506
CUILLÈRE DE TABLE
TABLE/PASTA SPOON
21,6 CM - 8 IN^{1/2}



197518
CUILLÈRE À SOUPE ANGLAISE
BOUILLON SPOON, ROUND
18,5 CM - 7 IN^{5/16}



197512
CUILLÈRE À DESSERT
DESSERT/SOUP SPOON, OVAL
19,5 CM - 7 IN^{11/16}



197511
FOURCHETTE À DESSERT
DESSERT/SALAD FORK
19,2 CM - 7 IN^{9/16}



210629
COUTEAU À DESSERT
MONOBLOC LAME SCIE
DESSERT KNIFE SOLID HANDLE
SERRATED
20,9 CM - 8 IN^{3/16}



235482
COUTEAU À DESSERT
MONOBLOC LAME UNIE
DESSERT KNIFE SOLID HANDLE
21,3 CM - 8 IN^{3/8}



197520
COUTEAU À BEURRE
MONOBLOC LAME UNIE
BUTTER KNIFE SOLID HANDLE
19,3 CM - 7 IN^{5/8}



181112
TARTINEUR
XY
BUTTER SPREADER
16 CM - 6 IN^{5/16}



197514
FOURCHETTE À POISSON
FISH FORK
19,2 CM - 7 IN^{9/16}



197515
COUTEAU À POISSON/GOURMET
GOURMET FISH KNIFE
21,3 CM - 8 IN^{3/8}



197508
CUILLÈRE À CAFÉ
COFFEE/TEA SPOON
14,3 CM - 5 IN^{5/8}



197510
CUILLÈRE À MOKA
DEMI TASSE SPOON
11,7 CM - 4 IN^{5/8}



190018
CUILLÈRE À SODA
DROIT
ICED TEA SPOON
19 CM - 7 IN^{1/2}



197516
FOURCHETTE À GÂTEAUX/COCKTAIL
PASTRY/COCKTAIL FORK
13,9 CM - 5 IN^{1/2}



190424
FOURCHETTE À HÙÎTRES
DROIT
OYSTER FORK
14,5 CM - 5 IN^{11/16}



197522
FOURCHETTE DE SERVICE
SERVING FORK
26,6 CM - 10 IN^{1/2}



197523
CUILLÈRE DE SERVICE
SERVING SPOON
27 CM - 10 IN^{5/8}



197525
SERVICE À SALADE
SALAD SERVING SET
30 CM - 11 IN^{3/16}



197527
PELLE À TARTE MONOBLOC
PASTRY SERVER SOLID HANDLE
25,1 CM - 9 IN^{7/8}



153193
LOUCHE
DROIT
SOUP LADLE
35,5 CM - 14 IN



154606
CUILLÈRE À SAUCE
DROIT
SAUCE LADLE
20,4 CM - 8 IN^{7/16}



ÉGALEMENT DISPONIBLE EN MÉTAL ARGENTÉ
ALSO AVAILABLE IN SILVERPLATED FINISH



Possibilité de personnalisation
Bespoke options available

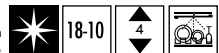

GUEST MIROIR

All day dining



L'abus d'alcool est dangereux pour la santé
Alcohol abuse is dangerous for your health

GUEST CUIVRE COPPER



230848
FOURCHETTE DE TABLE
TABLE FORK
21,3 CM - 8 IN^{3/8}



230850
COUPEAU DE TABLE
MONOBLOC LAME SCIE
TABLE KNIFE SOLID HANDLE SERRATED
23,2 CM - 9 IN^{1/8}



230849
CUILLÈRE DE TABLE
TABLE/PASTA SPOON
21,6 CM - 8 IN^{1/2}



230854
CUILLÈRE À DESSERT
DESSERT/SOUP SPOON, OVAL
19,5 CM - 7 IN^{11/16}



230853
FOURCHETTE À DESSERT
DESSERT/SALAD FORK
19,2 CM - 7 IN^{9/16}



230855
COUPEAU À DESSERT
MONOBLOC LAME SCIE
DESSERT KNIFE SOLID HANDLE
SERRATED
20,9 CM - 8 IN^{3/16}



230851
CUILLÈRE À CAFÉ
COFFEE/TEA SPOON
14,3 CM - 5 IN^{5/8}



230852
CUILLÈRE À MOKA
DEMI TASSE SPOON
11,7 CM - 4 IN^{5/8}



GUEST CUIVRE

Finedining





223482
FOURCHETTE DE TABLE
TABLE FORK
21,3 CM - 8 IN^{3/8}



223483
CUILLÈRE À CAFÉ
COFFEE/TEA SPOON
14,3 CM - 5 IN^{5/8}



202995
COUTEAU DE TABLE
MONOBLOC LAME SCIE
TABLE KNIFE SOLID HANDLE SERRATED
23,2 CM - 9 IN^{1/8}



223484
CUILLÈRE À MOKA
DEMI TASSE SPOON
11,7 CM - 4 IN^{5/8}



203017
COUTEAU À STEAK
MONOBLOC LAME SCIE
STEAK KNIFE SOLID HANDLE SERRATED
23,2 CM - 9 IN^{1/8}



223492
CUILLÈRE À SODA
ICED TEA SPOON
18,9 CM - 7 IN^{7/16}



223481
CUILLÈRE DE TABLE
TABLE/PASTA SPOON
21,6 CM - 8 IN^{1/2}



223489
FOURCHETTE À GÂTEAUX/COCKTAIL
PASTRY/COCKTAIL FORK
13,9 CM - 5 IN^{1/2}



223491
CUILLÈRE À SOUPE ANGLAISE
BOUILLON SPOON, ROUND
18,5 CM - 7 IN^{9/16}



223493
FOURCHETTE DE SERVICE
SERVING FORK
26,6 CM - 10 IN^{1/2}



223486
CUILLÈRE À DESSERT
DESSERT/SOUP SPOON, OVAL
19,5 CM - 7 IN^{11/16}



223494
CUILLÈRE DE SERVICE
SERVING SPOON
27 CM - 10 IN^{5/8}



223485
FOURCHETTE À DESSERT
DESSERT/SALAD FORK
19,2 CM - 7 IN^{9/16}



223497
PELLE À TARTE MONOBLOC
PASTRY SERVER SOLID HANDLE
25,1 CM - 9 IN^{7/8}



210630
COUTEAU À DESSERT
MONOBLOC LAME SCIE
DESSERT KNIFE SOLID HANDLE
SERRATED
20,9 CM - 8 IN^{3/16}



203016
COUTEAU À BEURRE
MONOBLOC LAME UNIE
BUTTER KNIFE SOLID HANDLE
19,3 CM - 7 IN^{9/8}



223487
FOURCHETTE À POISSON
FISH FORK
19,2 CM - 7 IN^{9/16}



223488
COUTEAU À POISSON/GOURMET
GOURMET FISH KNIFE
21,3 CM - 8 IN^{3/8}

GUEST STAR

Finedining





217139
FOURCHETTE DE TABLE
TABLE FORK
21,3 CM - 8 IN^{3/8}



217140
COUTEAU DE TABLE
MONOBLOC LAME SCIE
TABLE KNIFE SOLID HANDLE SERRATED
23,2 CM - 9 IN^{1/8}



230339
COUTEAU À STEAK
MONOBLOC LAME SCIE
STEAK KNIFE SOLID HANDLE SERRATED
23,2 CM - 9 IN^{1/8}



246255
COUTEAU DE TABLE
DROIT LAME SCIE
TABLE KNIFE SOLID HANDLE SERRATED
23,2 CM - 9 IN^{1/8}



217141
CUILLÈRE DE TABLE
TABLE/PASTA SPOON
21,6 CM - 8 IN^{1/2}



217143
CUILLÈRE À DESSERT
DESSERT/SOUP SPOON, OVAL
19,5 CM - 7 IN^{11/16}



217144
FOURCHETTE À DESSERT
DESSERT/SALAD FORK
19,2 CM - 7 IN^{9/16}



217145
COUTEAU À DESSERT
MONOBLOC LAME SCIE
DESSERT KNIFE SOLID HANDLE
SERRATED
20,9 CM - 8 IN^{3/16}



246257
COUTEAU À DESSERT
DROIT LAME SCIE
DESSERT KNIFE SOLID HANDLE
SERRATED
20,9 CM - 8 IN^{3/16}



217142
CUILLÈRE À CAFÉ
COFFEE/TEA SPOON
14,3 CM - 5 IN^{5/8}



217146
CUILLÈRE À MOKA
DEMI TASSE SPOON
11,7 CM - 4 IN^{5/8}

GUEST VINTAGE

Finedining





241006
FOURCHETTE DE TABLE
TABLE FORK
20,6 CM - 8 IN^{1/2}



241010
COUTEAU DE TABLE MONOBLOC LAME SCIE
TABLE KNIFE SOLID HANDLE SERRATED
23,9 CM - 9 IN^{7/16}



241004
CUILLÈRE DE TABLE
TABLE/PASTA SPOON
20,7 CM - 8 IN^{1/8}



241032
CUILLÈRE À SOUPE ANGLAISE
BOUILLON SPOON, ROUND
17,4 CM - 6 IN^{7/8}



241012
CUILLÈRE À DESSERT
DESSERT/SOUP SPOON, OVAL
18,6 CM - 7 IN^{5/16}



241014
FOURCHETTE À DESSERT
DESSERT/SALAD FORK
18,5 CM - 7 IN^{1/16}



241016
COUTEAU À DESSERT MONOBLOC LAME UNIE
DESSERT KNIFE SOLID HANDLE
21,5 CM - 8 IN^{7/16}



241008
CUILLÈRE À CAFÉ
COFFEE/TEA SPOON
14,2 CM - 5 IN^{9/16}



241018
CUILLÈRE À MOKA
DEMI TASSE SPOON
11,2 CM - 4 IN^{7/16}



241026
FOURCHETTE À POISSON
FISH FORK
18,5 CM - 7 IN^{5/16}



241028
COUTEAU À POISSON
FISH KNIFE
20,6 CM - 8 IN^{1/8}



241030
COUTEAU À BEURRE MONOBLOC
BUTTER KNIFE SOLID HANDLE
18,6 CM - 7 IN^{5/16}



241020
CUILLÈRE DE SERVICE
SERVING SPOON
26,1 CM - 10 IN^{1/4}



241021
FOURCHETTE DE SERVICE
SERVING FORK
26 CM - 10 IN^{1/4}

EGALEMENT DISPONIBLE EN MÉTAL ARGENTÉ
ALSO AVAILABLE IN SILVERPLATED FINISH



Possibilité de personnalisation
Bespoke options available

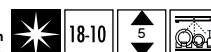

L'EMPREINTE

Finedining





239122
FOURCHETTE DE TABLE
TABLE FORK
20,5 CM - 8 IN^{1/16}



239123
COUPEAU DE TABLE
MONOBLOC À BOUT POINTU
LAME SCIE
TABLE KNIFE SOLID HANDLE POINTED
BLADE SERRATED
23,3 CM - 9 IN^{3/16}



233014
COUPEAU DE TABLE
MONOBLOC À BOUT ROND
LAME SCIE
TABLE KNIFE SOLID HANDLE ROUNDED
BLADE SERRATED
23,3 CM - 9 IN^{3/16}



239121
CUILLÈRE DE TABLE
TABLE/PASTA SPOON
20,5 CM - 8 IN^{1/16}



233022
CUILLÈRE À SOUPE ANGLAISE
BOUILLON SPOON, ROUND
18,5 CM - 7 IN^{5/16}



239128
CUILLÈRE À DESSERT
DESSERT/SOUP SPOON, OVAL
18,5 CM - 7 IN^{5/16}



239127
FOURCHETTE À DESSERT
DESSERT/SALAD FORK
18,5 CM - 7 IN^{5/16}



239129
COUPEAU À DESSERT
MONOBLOC À BOUT ROND
LAME UNIE
DESSERT KNIFE SOLID HANDLE
ROUNDED BLADE
20,9 CM - 8 IN^{1/4}



239133
COUPEAU À BEURRE
MONOBLOC LAME UNIE
BUTTER KNIFE SOLID HANDLE
17,5 CM - 6 IN^{7/8}



239125
CUILLÈRE À CAFÉ
COFFEE/TEA SPOON
13,9 CM - 5 IN^{1/2}



239126
CUILLÈRE À MOKA
DEMI TASSE SPOON
11,7 CM - 4 IN^{5/8}



239134
FOURCHETTE DE SERVICE
SERVING FORK
26,3 CM - 10 IN^{3/8}



239135
CUILLÈRE DE SERVICE
SERVING SPOON
26,3 CM - 10 IN^{3/8}

L'É STARCK®

All day dining





111894
FOURCHETTE DE TABLE
 TABLE FORK
 20,4 CM - 8 IN^{1/16}



111921
COUTEAU DE TABLE
MONOBLOC LAME SCIE
 TABLE KNIFE SOLID HANDLE SERRATED
 23 CM - 9 IN^{1/16}



111891
CUILLÈRE DE TABLE
 TABLE/PASTA SPOON
 20,4 CM - 8 IN^{1/16}



111904
CUILLÈRE À DESSERT
 DESSERT/SOUP SPOON, OVAL
 18 CM - 7 IN^{1/16}



111907
FOURCHETTE À DESSERT
 DESSERT/SALAD FORK
 18 CM - 7 IN^{1/16}



210631
COUTEAU À DESSERT
MONOBLOC LAME SCIE
 DESSERT KNIFE SOLID HANDLE
 SERRATED
 20,3 CM - 8 IN



181112
TARTINEUR
XY
 BUTTER SPREADER
 16 CM - 6 IN^{5/16}



111897
CUILLÈRE À CAFÉ
 COFFEE/TEA SPOON
 13,6 CM - 5 IN^{3/8}



114437
CUILLÈRE À MOKA
 DEMI TASSE SPOON
 11 CM - 4 IN^{5/16}

EGALEMENT DISPONIBLE EN MÉTAL ARGENTÉ
 ALSO AVAILABLE IN SILVERPLATED FINISH



Possibilité de personnalisation
 Bespoke options available



NORWAY

Alldaydining

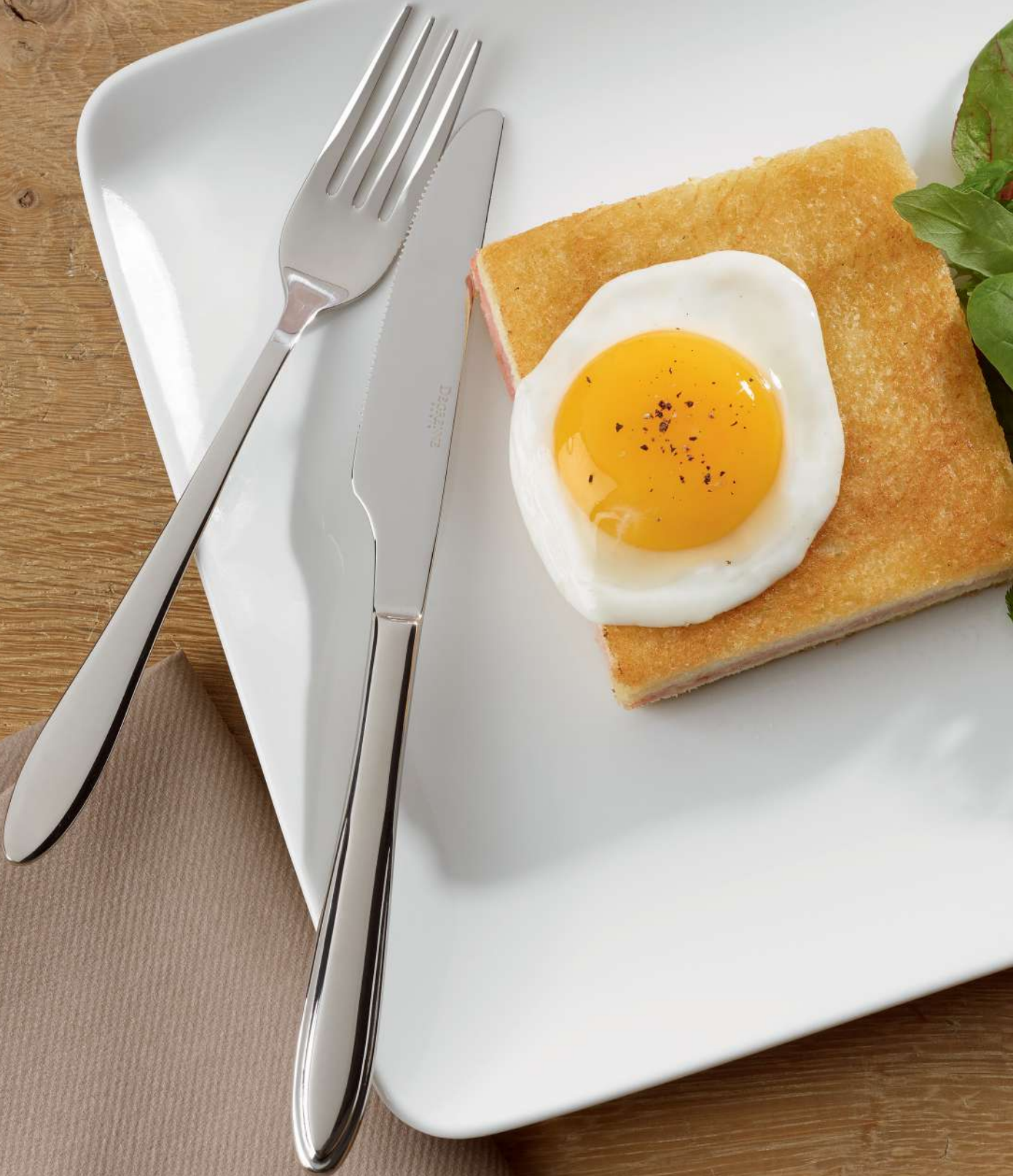



235927
FOURCHETTE DE TABLE
TABLE FORK
19,9 CM - 7 IN^{13/16}



235930
COUTEAU DE TABLE
MONOBLOC LAME SCIE
TABLE KNIFE SOLID HANDLE SERRATED
23,2 CM - 9 IN^{1/8}



235928
CUILLÈRE DE TABLE
TABLE/PASTA SPOON
19,9 CM - 7 IN^{13/16}



235938
CUILLÈRE À SOUPE ANGLAISE
BOUILLON SPOON, ROUND
18,4 CM - 7 IN^{1/4}



235934
CUILLÈRE À DESSERT
DESSERT/SOUP SPOON, OVAL
18,4 CM - 7 IN^{1/4}



235933
FOURCHETTE À DESSERT
DESSERT/SALAD FORK
18,4 CM - 7 IN^{1/4}



235935
COUTEAU À DESSERT
MONOBLOC LAME SCIE
DESSERT KNIFE SOLID HANDLE SERRATED
20,9 CM - 8 IN^{3/16}



235939
COUTEAU À BEURRE
MONOBLOC LAME UNIE
BUTTER KNIFE SOLID HANDLE
16,5 CM - 6 IN^{1/2}



235929
CUILLÈRE À CAFÉ
COFFEE/TEA SPOON
13,9 CM - 5 IN^{1/2}



235932
CUILLÈRE À MOKA
DEMI TASSE SPOON
10,9 CM - 4 IN^{5/16}



235937
FOURCHETTE À GÂTEAUX/
COCKTAIL
PASTRY/COCKTAIL FORK
14,1 CM - 5 IN^{3/16}



231218
FOURCHETTE DE SERVICE
GOUTTE
SERVING FORK
26,6 CM - 10 IN^{1/2}



231219
CUILLÈRE DE SERVICE
GOUTTE
SERVING SPOON
26,6 CM - 10 IN^{1/2}



231221
PELLE À TARTE MONOBLOC
GOUTTE
PASTRY SERVER SOLID HANDLE
25,2 CM - 9 IN^{15/16}



231220
LOUCHE
GOUTTE
SOUP LADLE
29 CM - 11 IN^{7/16}

EGALEMENT DISPONIBLE EN MÉTAL ARGENTÉ
ALSO AVAILABLE IN SILVERPLATED FINISH



Possibilité de personnalisation
Bespoke options available



ONDE

Alldaydining





236968
FOURCHETTE DE TABLE
 TABLE FORK
 19,9 CM - 7 IN^{13/16}



239336
COUTEAU DE TABLE
MONOBLOC LAME SCIE
 TABLE KNIFE SOLID HANDLE SERRATED
 23,2 CM - 9 IN^{1/8}



236970
CUILLÈRE DE TABLE
 TABLE/PASTA SPOON
 19,9 CM - 7 IN^{13/16}



236976
CUILLÈRE À SOUPE ANGLAISE
 BOUILLON SPOON, ROUND
 17,9 CM - 7 IN^{1/16}



236971
CUILLÈRE À DESSERT
 DESSERT/SOUP SPOON, OVAL
 17,9 CM - 7 IN^{1/16}



236972
FOURCHETTE À DESSERT
 DESSERT/SALAD FORK
 17,9 CM - 7 IN^{1/16}



239337
COUTEAU À DESSERT
MONOBLOC LAME UNIE
 DESSERT KNIFE SOLID HANDLE
 20,9 CM - 8 IN^{3/16}



236978
COUTEAU À BEURRE
MONOBLOC LAME UNIE
 BUTTER KNIFE SOLID HANDLE
 16,5 CM - 6 IN^{1/2}



236974
CUILLÈRE À CAFÉ
 COFFEE/TEA SPOON
 13,9 CM - 5 IN^{1/2}



236975
CUILLÈRE À MOKA
 DEMI TASSE SPOON
 10,9 CM - 4 IN^{5/16}



236977
FOURCHETTE À COCKTAIL/
ESCARGOTS
 SNAIL/COCKTAIL FORK
 14,1 CM - 5 IN^{9/16}



236981
FOURCHETTE DE SERVICE
 SERVING FORK
 26,6 CM - 10 IN^{1/2}



236982
CUILLÈRE DE SERVICE
 SERVING SPOON
 26,6 CM - 10 IN^{1/2}



237180
PELLE À TARTE MONOBLOC
 PASTRY SERVER SOLID HANDLE
 25,2 CM - 9 IN^{5/16}

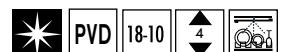

ONDE GOLD

Finedining





163598
FOURCHETTE DE TABLE
 TABLE FORK
 20,2 CM - 7 IN^{15/16}



11970
COUTEAU DE TABLE
MONOBLOC LAME SCIE
 TABLE KNIFE SOLID HANDLE SERRATED
 22,9 CM - 9 IN



163597
CUILLÈRE DE TABLE
 TABLE/PASTA SPOON
 20,4 CM - 8 IN



163602
CUILLÈRE À DESSERT
 DESSERT/SOUP SPOON, OVAL
 18,4 CM - 7 IN^{3/4}



163603
FOURCHETTE À DESSERT
 DESSERT/SALAD FORK
 18,5 CM - 7 IN^{3/4}



111076
COUTEAU À DESSERT
MONOBLOC LAME UNIE
 DESSERT KNIFE SOLID HANDLE
 20,4 CM - 8 IN



181112
TARTINEUR
XY
 BUTTER SPREADER
 16 CM - 6 IN^{5/16}



163599
CUILLÈRE À CAFÉ
 COFFEE/TEA SPOON
 14,1 CM - 5 IN^{1/2}

EGALEMENT DISPONIBLE EN MÉTAL ARGENTÉ
 ALSO AVAILABLE IN SILVERPLATED FINISH



Possibilité de personnalisation
 Bespoke options available

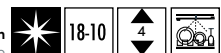

OVATION

Finedining

MADE IN FRANCE





246423
FOURCHETTE DE TABLE
TABLE FORK
21 CM - 8 IN^{1/4}



246427
COUTEAU DE TABLE
MONOBLOC LAME SCIE
TABLE KNIFE SOLID HANDLE SERRATED
23,5 CM - 9 IN^{1/4}



246425
CUILLÈRE DE TABLE
TABLE/PASTA SPOON
20,8 CM - 8 IN^{3/16}



246439
CUILLÈRE À SOUPE ANGLAISE
BOUILLON SPOON
18,1 CM - 7 IN^{1/8}



246431
CUILLÈRE À DESSERT
DESSERT/SOUP SPOON, OVAL
18,9 CM - 7 IN^{7/16}



246429
FOURCHETTE À DESSERT/POISSON
FISH/DESSERT FORK
18,9 CM - 7 IN^{7/16}



246441
COUTEAU À POISSON/GOURMET
GOURMET/FISH KNIFE
20,5 CM - 8 IN^{1/16}



246433
COUTEAU À DESSERT
MONOBLOC LAME UNIE
DESSERT KNIFE SOLID HANDLE
21,1 CM - 8 IN^{5/16}



246445
COUTEAU À BEURRE
MONOBLOC LAME UNIE
BUTTER KNIFE SOLID HANDLE
18,3 CM - 7 IN^{3/16}



246435
CUILLÈRE À CAFÉ
COFFEE/TEA SPOON
14,5 CM - 5 IN^{11/16}



246437
CUILLÈRE À MOKA
DEMI TASSE SPOON
11,6 CM - 4 IN^{9/16}



246443
FOURCHETTE À GATEAUX/COCKTAIL
PASTRY/COCKTAIL FORK
14,5 CM - 5 IN^{11/16}



246448
FOURCHETTE DE SERVICE
SERVING FORK
26,3 CM - 10 IN^{3/8}



246447
CUILLÈRE DE SERVICE
SERVING SPOON
26,3 CM - 10 IN^{3/8}



RIVAGE

Alldaydining

NEW





205540
FOURCHETTE DE TABLE
TABLE FORK
20,9 CM - 8 IN^{3/16}



159484
COUTEAU DE TABLE N°1
MONOBLOC LAME SCIE
TABLE KNIFE SOLID HANDLE SERRATED
23,2 CM - 9 IN^{3/8}



235481
COUTEAU DE TABLE
MONOBLOC LAME SCIE
GUEST
TABLE KNIFE SOLID HANDLE SERRATED
23,7 CM - 9 IN^{5/16}



159451
COUTEAU À STEAK
MONOBLOC LAME SCIE
GOURMET
STEAK KNIFE SOLID HANDLE SERRATED
23,5 CM - 9 IN^{1/4}



235482
COUTEAU DESSERT
MONOBLOC LAME UNIE
GUEST
DESSERT KNIFE SOLID HANDLE
21,3 CM - 8 IN^{3/8}



205541
CUILLÈRE DE TABLE
TABLE/PASTA SPOON
20,9 CM - 8 IN^{1/4}



205547
CUILLÈRE À DESSERT
DESSERT/SOUP SPOON, OVAL
18,4 CM - 7 IN^{1/4}



205546
FOURCHETTE À DESSERT
DESSERT/SALAD FORK
18,4 CM - 7 IN^{1/4}



159492
COUTEAU À DESSERT N°1
MONOBLOC LAME UNIE
DESSERT KNIFE SOLID HANDLE
20,4 CM - 8 IN^{1/16}



181112
TARTINEUR
XY
BUTTER SPREADER
16 CM - 6 IN^{3/16}



205544
FOURCHETTE À POISSON
FISH FORK
18,4 CM - 7 IN^{1/4}



205545
COUTEAU À POISSON/
GOURMET
GOURMET FISH KNIFE
20,7 CM - 8 IN^{1/8}



205543
CUILLÈRE À CAFÉ
COFFEE/TEA SPOON
14 CM - 5 IN^{1/2}



159512
CUILLÈRE À MOKA
DEMI TASSE SPOON
11,1 CM - 4 IN^{3/8}



190018
CUILLÈRE À SODA
DROIT
ICED TEA SPOON
19 CM - 7 IN^{1/2}



205548
FOURCHETTE À GÂTEAUX/
COCKTAIL
PASTRY/COCKTAIL FORK
14,3 CM - 5 IN^{5/8}



190424
FOURCHETTE À HÙÎTRES
DROIT
OYSTER FORK
14,5 CM - 5 IN^{11/16}



159501
FOURCHETTE DE SERVICE
SERVING FORK
26 CM - 10 IN^{1/4}



159500
CUILLÈRE DE SERVICE
SERVING SPOON
26 CM - 10 IN^{1/4}



153193
LOUCHE
DROIT
SOUP LADLE
35,5 CM - 14 IN



154606
CUILLÈRE À SAUCE
DROIT
SAUCE SPOON
20,4 CM - 8 IN^{1/16}

EGALEMENT DISPONIBLE EN MÉTAL ARGENTÉ
ALSO AVAILABLE IN SILVERPLATED FINISH



Possibilité de personnalisation
Bespoke options available



SOLSTICE

Finedining



MADE IN FRANCE





242668
FOURCHETTE DE TABLE
TABLE FORK
20,1 CM - 7 IN^{15/16}



242674
COUTEAU DE TABLE
MONOBLOC LAME SCIE
TABLE KNIFE SOLID HANDLE SERRATED
23,5 CM - 9 IN^{1/4}



242665
CUILLÈRE DE TABLE
TABLE/PASTA SPOON
20,3 CM - 8 IN



242689
CUILLÈRE À SOUPE ANGLAISE
BOUILLON SPOON, ROUND
17,9 CM - 7 IN^{1/16}



242677
CUILLÈRE À DESSERT
DESSERT/SOUP SPOON, OVAL
17,8 CM - 7 IN



242680
FOURCHETTE À DESSERT
DESSERT/SALAD FORK
17,7 CM - 6 IN^{15/16}



242683
COUTEAU À DESSERT
MONOBLOC LAME UNIE
DESSERT KNIFE SOLID HANDLE
20,7 CM - 8 IN^{1/8}



242705
COUTEAU À BEURRE MONOBLOC
BUTTER KNIFE SOLID HANDLE
18,1 CM - 8 IN^{1/8}



242671
CUILLÈRE À CAFÉ
COFFEE/TEA SPOON
13,7 CM - 5 IN^{3/8}



242686
CUILLÈRE À MOKA
COFFEE/TEA SPOON
11,1 CM - 4 IN^{5/16}

SUPERNATURE

Finedining



MADE IN FRANCE





205559
FOURCHETTE DE TABLE
TABLE FORK
21,3 CM - 8 IN^{3/8}



193776
COUTEAU DE TABLE
MONOBLOC LAME SCIE
TABLE KNIFE SOLID HANDLE SERRATED
23,3 CM - 9 IN^{3/16}



205560
CUILLÈRE DE TABLE
TABLE/PASTA SPOON
20,5 CM - 8 IN^{1/16}



205561
CUILLÈRE À SOUPE ANGLAISE
BOUILLON SPOON, ROUND
18,5 CM - 7 IN^{5/16}



205567
CUILLÈRE GOURMANDE
DESSERT /SOUP SPOON, OVAL
18,6 CM - 7 IN^{5/16}



205566
FOURCHETTE GOURMANDE
DESSERT/SALAD FORK
18,6 CM - 7 IN^{5/16}



181111
COUTEAU À DESSERT
MONOBLOC LAME UNIE
DESSERT KNIFE SOLID HANDLE
20,6 CM - 8 IN^{1/8}



181112
TARTINEUR
BUTTER SPREADER
16 CM - 6 IN^{5/16}



205563
FOURCHETTE À POISSON
FISH FORK
20 CM - 7 IN^{7/8}



205564
SPATULE GOURMET
GOURMET SPATULA
20,2 CM - 7 IN^{15/16}



205565*
FOURCHETTE GOURMET
GOURMET FORK
20 CM - 7 IN^{7/8}



205562
CUILLÈRE À CAFÉ
COFFEE/TEA SPOON
14,3 CM - 5 IN^{5/8}



181109
CUILLÈRE À MOKA
DEMI TASSE SPOON
11 CM - 4 IN^{5/16}



190018
CUILLÈRE À SODA
ICED TEA SPOON
19 CM - 7 IN^{1/2}



181119
FOURCHETTE MISE EN BOUCHE
COCKTAIL FORK
15,5 CM - 6 IN^{1/8}



181120
SPATULE MISE EN BOUCHE
COCKTAIL SPATULA
15,5 CM - 6 IN^{1/8}



181121
CUILLÈRE MISE EN BOUCHE
COCKTAIL SPOON
11,6 CM - 4 IN^{9/16}



190424
FOURCHETTE À HÙITRES
OYSTER FORK
14,5 CM - 5 IN^{11/16}



181114
FOURCHETTE DE SERVICE
SERVING FORK
26 CM - 10 IN^{1/4}



181113
CUILLÈRE DE SERVICE
SERVING SPOON
26 CM - 10 IN^{1/4}



181122
SPATULE DE SERVICE
SERVING SPATULA
25 CM - 9 IN^{13/16}



189999
SERVICE À SALADE
SALAD SERVING SET
30 CM - 11 IN^{13/16}



153193
LOUCHE
SOUP LADLE
35,5 CM - 14 IN



154606
LOUCHE À SAUCE
SAUCE LADLE
20,4 CM - 8 IN^{11/16}

EGALEMENT DISPONIBLE EN MÉTAL ARGENTÉ
ALSO AVAILABLE IN SILVERPLATED FINISH



*Arrêt à épuisement des stocks
Until stock limited

Possibilité de personnalisation
Bespoke options available

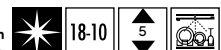

XY

Finedining





205568
FOURCHETTE DE TABLE
TABLE FORK
21,3 CM - 8 IN^{3/8}



195028
COUTEAU DE TABLE
MONOBLOC LAME SCIE
TABLE KNIFE SOLID HANDLE SERRATED
23,3 CM - 9 IN^{3/16}



205569
CUILLÈRE DE TABLE
TABLE/PASTA SPOON
20,5 CM - 8 IN^{1/16}



200483
CUILLÈRE À SOUPE ANGLAISE
BOUILLON SPOON, ROUND
18,5 CM - 7 IN^{5/16}



205575
CUILLÈRE GOURMANDE
DESSERT/SOUP SPOON, OVAL
18,6 CM - 7 IN^{5/16}



205574
FOURCHETTE GOURMANDE
DESSERT/SALAD FORK
18,6 CM - 7 IN^{5/16}



195031
COUTEAU À DESSERT
MONOBLOC LAME UNIE
DESSERT KNIFE SOLID HANDLE
20,6 CM - 8 IN^{1/8}



195036
TARTINEUR
BUTTER SPREADER
16 CM - 6 IN^{5/16}



205571
FOURCHETTE À POISSON
FISH FORK
20 CM - 7 IN^{7/8}



205572
SPATULE GOURMET
GOURMET SPATULA
20,2 CM - 7 IN^{15/16}



205573*
FOURCHETTE GOURMET
GOURMET FORK
20 CM - 7 IN^{7/8}



205570
CUILLÈRE À CAFÉ
COFFEE/TEA SPOON
14,3 CM - 5 IN^{5/8}



195034
CUILLÈRE À MOKA
DEMI TASSE SPOON
11 CM - 4 IN^{9/16}



196674
CUILLÈRE À SODA
ICED TEA SPOON
19 CM - 7 IN^{1/2}



195039
FOURCHETTE MISE EN BOUCHE
COCKTAIL FORK
15,5 CM - 6 IN^{1/8}



195042
SPATULE MISE EN BOUCHE
COCKTAIL SPATULA
15,5 CM - 6 IN^{1/8}



195041
CUILLÈRE MISE EN BOUCHE
COCKTAIL SPOON
11,6 CM - 4 IN^{9/16}



196014
FOURCHETTE À HUÎTRES
OYSTER FORK
14,1 CM - 5 IN^{9/16}



199773
FOURCHETTE DE SERVICE
SERVING FORK
26 CM - 10 IN^{1/4}



199774
CUILLÈRE DE SERVICE
SERVING SPOON
26 CM - 10 IN^{1/4}



199769
SPATULE DE SERVICE
SERVING SPATULA
25 CM - 9 IN^{13/16}



199771
SERVICE À SALADE
SALAD SERVING SET
30 CM - 11 IN^{13/16}

*Arrêt à épuisement des stocks
Until stock limited

Possibilité de personnalisation
Bespoke options available



XY BLACK MIROIR

Finedining





L'abus d'alcool est dangereux pour la santé
Alcohol abuse is dangerous for your health

LES PIÈCES COMPLÉMENTAIRES

Additional Pieces

MIRAGE LES ESSENCES

MANCHES EN BOIS VERITABLE GENUINE WOODEN HANDLES



243524
COUTEAU À STEAK LAME UNIE MANCHE OLIVIER
STEAK KNIFE SOLID HANDLE OLIVE WOOD HANDLE
23 CM - 9 IN^{5/16}



243528
COUTEAU À STEAK LAME UNIE MANCHE PICANA
STEAK KNIFE SOLID HANDLE PICANA HANDLE
23 CM - 9 IN^{5/16}



243525
COUTEAU À STEAK LAME UNIE MANCHE ÉBÈNE
STEAK KNIFE SOLID HANDLE EBONY HANDLE
23 CM - 9 IN^{5/16}

MIRAGE



226261
COUTEAU DE TABLE/ STEAK LAME UNIE ANTHRACITE
BLACK TABLE STEAK KNIFE
23 CM - 9 IN^{5/16}



226263
COUTEAU DE TABLE/ STEAK LAME UNIE BLANC
WHITE TABLE STEAK KNIFE
23 CM - 9 IN^{5/16}

LE PHIL



246174
COUTEAU À STEAK MONOBLOC LAME UNIE
STEAK KNIFE SOLID HANDLE
23,7 CM - 9 IN^{5/16}

LE PHIL VINTAGE **NEW**



247404
COUTEAU À STEAK MONOBLOC LAME UNIE
STEAK KNIFE SOLID HANDLE
23,7 CM - 9 IN^{5/16}

COUTEAUX ORFÈVRE

HOLLOW HANDLE



122759
COUTEAU À STEAK MANCHE ORFEVRE LAME SCIE BLOIS
BLOIS STEAK KNIFE HOLLOW HANDLE SERRATED
23,9 CM - 9 IN^{7/16}



127654
COUTEAU À STEAK MANCHE ORFEVRE LAME SCIE FLORENCIA
FLORENCIA STEAK KNIFE HOLLOW HANDLE SERRATED
23,9 CM - 9 IN^{7/16}



122746
COUTEAU À STEAK MANCHE ORFEVRE LAME SCIE LUTECE
LUTECE STEAK KNIFE HOLLOW HANDLE SERRATED
23,8 CM - 9 IN^{5/8}



186278
COUTEAU À STEAK MANCHE ORFEVRE LAME SCIE MARQUISE
MARQUISE STEAK KNIFE HOLLOW HANDLE SERRATED
23,9 CM - 9 IN^{7/16}



128841
COUTEAU À STEAK MANCHE ORFEVRE LAME SCIE MILADY
MILADY STEAK KNIFE HOLLOW HANDLE SERRATED
23,9 CM - 9 IN^{7/16}



105801
COUTEAU À STEAK MANCHE ORFEVRE LAME SCIE VERLAINE
VERLAINE STEAK KNIFE HOLLOW HANDLE SERRATED
23,9 CM - 9 IN^{7/16}

COUTEAUX STEAK



DEGRENE
LA MANUFACTURE

COUTEAUX STEAK

STEAK KNIVES



199761
COUTEAU À STEAK MONOBLOC LAME SCIE ASTRÉE CISELÉ
 ASTREE CISELÉ STEAK KNIFE SOLID HANDLE SERRATED
 22,8 CM - 9 IN



160433
COUTEAU À STEAK MONOBLOC LAME SCIE CONFIDENCE
 CONFIDENCE STEAK KNIFE SOLID HANDLE SERRATED
 23,6 CM - 9 IN^{5/16}



159451
COUTEAU À STEAK MONOBLOC LAME SCIE GOURMET
 GOURMET STEAK KNIFE SOLID HANDLE SERRATED
 23,5 CM - 9 IN^{1/4}



197521
COUTEAU À STEAK MONOBLOC LAME SCIE GUEST
 GUEST STEAK KNIFE SOLID HANDLE SERRATED
 23,2 CM - 9 IN^{1/8}



203017
COUTEAU À STEAK MONOBLOC LAME SCIE GUEST STAR
 GUEST STAR STEAK KNIFE SOLID HANDLE SERRATED
 23,2 CM - 9 IN^{1/8}



230339
COUTEAU À STEAK MONOBLOC LAME SCIE GUEST VINTAGE
 GUEST VINTAGE STEAK KNIFE SOLID HANDLE SERRATED
 23,2 CM - 9 IN^{1/8}



160427
COUTEAU À STEAK MONOBLOC LAME SCIE MIKADO
 MIKADO STEAK KNIFE SOLID HANDLE SERRATED
 23,2 CM - 9 IN^{1/8}



230293
COUTEAU À STEAK MONOBLOC LAME SCIE MIKADO VINTAGE
 MIKADO VINTAGE STEAK KNIFE SOLID HANDLE SERRATED
 23,2 CM - 9 IN^{1/8}



160424
COUTEAU À STEAK MONOBLOC LAME SCIE VIEUX PARIS
 VIEUX PARIS STEAK KNIFE SOLID HANDLE SERRATED
 23,2 CM - 9 IN^{1/8}

PETIT GOURMET/ENFANT

KID



207257
FOURCHETTE À DESSERT
 DESSERT/SALAD FORK
 16,5 CM - 6 IN^{1/2}



207258
CUILLÈRE À DESSERT
 DESSERT/SOUP SPOON, OVAL
 16,5 CM - 6 IN^{1/2}



207259
COUTEAU À DESSERT MONOBLOC LAME UNIE
 DESSERT KNIFE SOLID HANDLE
 17,7 CM - 6 IN^{5/16}



207256
CUILLÈRE À CAFÉ
 COFFEE/TEA SPOON
 13,2 CM - 5 IN^{3/16}

Possibilité de personnalisation
 Bespoke options available



PIÈCES COMPLÉMENTAIRES

Additional pieces



VERLAINE



**105795
FOURCHETTE
À GÂTEAUX/
COCKTAIL**
PASTRY/
COCKTAIL FORK
13,8 CM - 5 IN^{7/16}



**002185
FOURCHETTE
DE SERVICE**
SERVING FORK
24,8 CM - 9 IN^{3/4}



**002186
CUILLÈRE
DE SERVICE**
SERVING SPOON
25 CM - 9 IN^{13/16}



**040646
SERVICE
À SALADE**
SALADE
SERVING SET
25,8 CM - 10 IN^{3/16}



**083340
PELLE À TARTE
MONOBLOC**
PASTRY SERVER
SOLID HANDLE
24,9 CM - 9 IN^{3/16}



**097717
LOUCHE**
SOUP LADLE
29,8 CM - 11 IN^{3/4}



**002179
LOUCHE
À SAUCE**
SAUCE LADLE
15,7 CM - 6 IN^{3/16}

BLOIS



**104480
FOURCHETTE
À GÂTEAUX/
COCKTAIL**
PASTRY/
COCKTAIL FORK
13,8 CM - 5 IN^{7/16}



**195757
FOURCHETTE
DE SERVICE**
SERVING FORK
24,8 CM - 9 IN^{3/4}



**195755
CUILLÈRE
DE SERVICE**
SERVING SPOON
25 CM - 9 IN^{13/16}



**195750
SERVICE
À SALADE**
SALADE
SERVING SET
25,7 CM - 10 IN^{1/8}



**195753
PELLE À TARTE
MONOBLOC**
PASTRY SERVER
SOLID HANDLE
24,9 CM - 9 IN^{3/16}



**195762
LOUCHE**
SOUP LADLE
29,8 CM - 11 IN^{3/4}



**195759
LOUCHE
À SAUCE**
SAUCE LADLE
15,7 CM - 6 IN^{3/16}



**195757
FOURCHETTE
À DÉCOUPER**
CARVING FORK
24,8 CM - 9 IN^{3/4}



**189511
COUTEAU
À DÉCOUPER
MANCHE ORFÈVRE
LAME UNIE**
CARVING KNIFE
HOLLOW HANDLE
28,7 CM - 11 IN^{5/16}

CUILLÈRE À SODA
ICED TEA SPOON



UNIVERSEL DROIT
190018
19 CM - 7 IN^{1/2}

AQUATIC
189973
19 CM - 7 IN^{1/2}

ASTRÉE CISELÉ
190016
19 CM - 7 IN^{1/2}

BLOIS
124259
18,2 CM - 7 IN^{3/16}

CONFIDENCE
105800
18,2 CM - 7 IN^{3/16}

GUEST STAR
223492
18,9 CM - 7 IN^{7/16}

XY BLACK
196674
19 CM - 7 IN^{1/2}



MODULO
162724
CUILLÈRE À AGRUMES
CITRUS FRUITS SPOON
15,3 CM - 6 IN



MODULO
162730
CURETTE À CRUSTACÉS
SEAFOOD SCRAPER
19,1 CM - 7 IN^{1/2}



AQUATIC
189971
COUPEAU À BEURRE
MONOBLOC LAME UNIE
BUTTER KNIFE SOLID HANDLE
18,9 CM - 7 IN^{7/16}



181112
TARTINEUR
BUTTER SPREADER
16 CM - 6 IN^{5/16}

FOURCHETTE À HÛÎTRES
OYSTER FORKS



UNIVERSEL DROIT
190424
14,5 CM - 5 IN^{1/16}



AQUATIC
189974
14,1 CM - 5 IN^{9/16}



VIEUX PARIS
105803
13,2 CM - 5 IN^{3/16}



FLORENCIA
190418
13 CM - 5 IN^{1/2}



MARQUISE
190681
13 CM - 5 IN^{1/2}



MILADY
130266
13 CM - 5 IN^{1/2}



VERLAINE
105907
12,9 CM - 5 IN^{1/16}



MIKADO
104463
12,9 CM - 5 IN^{1/16}



XY BLACK
196014
14,1 CM - 5 IN^{9/16}



MODULO
162728
FOURCHETTE/
PIQUE À
ESCARGOTS/
COCKTAIL
COCKTAIL, SNAIL FORK
10,8 CM - 4 IN^{1/4}



VERLAINE
132782
FOURCHETTE
À ESCARGOTS
SNAIL FORK
13,5 CM - 5 IN^{5/16}

ACCESSOIRES PLATERIE
HOLLOWWARE ACCESSORIES



184492
PINCE À CRUSTACÉ
SEAFOOD CRACKER
16,5 CM - 6 IN^{1/2}



004013
PINCE À ESCARGOTS
SNAIL TONG
16 CM - 6 IN^{5/16}



204498
PINCE À PAIN
BREAD TONG
23 CM - 9 IN^{1/16}



204496
CISEAUX À GÂTEAUX
PASTRY CISSORS/TONG
20 CM - 7 IN^{7/8}



204499
PINCE À SERVIR
SERVING TONG
29,5 CM - 11 IN^{5/8}



LA VAISSELLE

Dinnerware

DEGRENNÉ travaille les formes et les matières en portant une attention particulière aux attentes des chefs, tant esthétiques que dans l'usage. Pour faire de la table un moment dédié aux plaisirs gastronomiques, du plus simple au plus élaboré, DEGRENNÉ imagine des collections uniques qui incarnent l'excellence et qui peuvent être associées entre elles. En jouant sur les combinaisons, les contrastes, les formes, les couleurs et les matières, chaque met trouve harmonieusement sa place à table, avec élégance et sobriété. Matières nobles, lignes épurées, épousez tous les savoir-faire DEGRENNÉ lorsque vous dressez votre table.

DEGRENNÉ develops shapes and materials, while paying careful attention to chefs' practical usage and aesthetic requirements. DEGRENNÉ designs unique collections that are the very embodiment of excellence and can also be combined, in order to make dining a moment of culinary pleasure, from the simplest to the most elaborate pleasures. Each dish harmoniously finds its rightful place on the table, with simplicity and elegance, thanks to the combinations, contrasts, shapes, colours and materials employed by DEGRENNÉ. Capitalize on DEGRENNÉ's extensive expertise when setting your table : we offer sleek lines and the finest materials.



PORCELAINE DE LIMOGES ET EXCELLENCE

Limoges Porcelain and Excellence



Alliez élégance et sobriété grâce à des matières nobles et des formes aux lignes épurées. D'une blancheur et d'une opalescence remarquables, **la Porcelaine de Limoges** est symbole d'excellence et de pureté.

Combine elegance and simplicity by harnessing the finest materials and sleek lines. Stunning white and milkily iridescent **Limoges Porcelain** is the epitome of excellence and purity.



Découvrez les coulisses de notre Manufacture à Limoges
Discover our factory in Limoges





ASSIETTE PLATE 227822
 ROUND EXT : 32 CM - 12 IN^{5/8}
 DINNER PLATE INT : 19,5 CM - 7 IN^{11/16}
 W/WIDE RIM

227823
 EXT : 28 CM - 11 IN
 INT : 17 CM - 6 IN^{11/16}

227824
 EXT : 24 CM - 9 IN^{7/16}
 INT : 15 CM - 5 IN^{7/8}



Compatible avec les assiettes cocottes
 Compatible with the shallow plate/cups

P 138-139



CLOCHE VERRE BOROSILICATE
 DOME GLASS
 COVER **204043**

17X9 CM
 6 IN^{11/16} X 3 IN^{9/16}

BOUCHON PORCELAINE
 PORCELAIN LID
206504
 5,2 CM - 2 IN^{1/8}



ASSIETTE 227826
GOURMET EXT : 30 CM - 11 IN^{13/16}
 ROUND INT : 14 CM - 5 IN^{1/2}
 SHALLOW BOWL

W/WIDE RIM **227827**
 EXT : 27,9 CM - 10 IN^{15/16}
 INT : 11,5 CM - 4 IN^{1/2}



Compatible avec les bols cocottes
 Compatible with the deep plate/cups

P 138-139

Compatible avec les bols biseautés cocottes
 Compatible with the slanted plate/cups

P 138-139



CLOCHE INOX 182614
 DOME COVER 24 CM - Ø 9 IN^{7/16}
 STAINLESS STEEL

182301
 14,8 CM - Ø 5 IN^{13/16}



ASSIETTE À PAIN 227825
 ROUND BREAD EXT : 14 CM - 5 IN^{1/2}
 & BUTTER PLATE INT : 9,5 CM - 3 IN^{3/4}
 W/WIDE RIM

COLLECTION L

Finedining

Haute Porcelaine de Limoges
High Limoges Porcelain





ASSIETTE CREUSE 232576
CALOTTE 18,5 CM
 ROUND 7 IN^{5/16}
 CEREAL PLATE



PLAT À TARTE 227839
 PIE/PIZZA 31,5 CM
 PLATE, 12 IN^{3/8}
 FLAT



PLAT ROND 227840
CREUX 30,5 CM
 ROUND 12 IN
 DEEP DISH



PLAT OVALE 227837
 OVAL DISH 36,5 X 26,5 CM
 14 IN^{3/8} X 10 IN^{7/16}



PLAT À CAKE 227838
RECTANGULAIRE 37 X 15 CM
 RECTANGULAR 14 IN^{9/16} X 5 IN^{7/8}
 DISH CAKE



SALADIER 227841
 SALAD BOWL 25 CM - 9 IN^{13/16}



VERSEUSE 245885
MULTIPLE 13 CM - 4 IN^{3/8}
 SAUCE JUG



COUPELLE 227842
 SMALL BOWL 13,5 CM - 5 IN^{5/16}



MUG 247590 NEW
 MUG 30 CL - 10 OZ^{1/8}



TASSE ESPRESSO 227828
 DEMITASSE CUP 10 CL - 3 OZ^{3/8} - 5,7 CM - 2 IN^{1/4}



TASSE LUNGO 227829
 COFFEE/TEA CUP 25 CL - 8 OZ^{7/16} - 8,5 CM - 3 IN^{3/8}

SOUCOUBE ESPRESSO 227831
 DEMITASSE SAUCER 12,6 CM - Ø 4 IN^{5/16}

SOUCOUBE LUNGO 227832
 COFFEE/TEA SAUCER 15,8 CM - Ø 6 IN^{1/4}



THÉIÈRE 227834
 TEA POT 1L - 33 OZ^{13/16}
 H 15,7 CM - Ø 12,4 CM
 H 6 IN^{7/8} - Ø 4 IN^{7/8}



SUCRIER 227836
 SUGAR BOWL 30 CL - 10 OZ^{1/8}
 H 10,8 CM - Ø 9,2 CM
 H 4 IN^{1/4} - Ø 3 IN^{5/8}



CRÉMIER 227835
 CREAM JUG 16 CL - 5 OZ^{7/16}
 H 8,5 CM - Ø 6,7 CM
 H 3 IN^{3/8} - Ø 2 IN^{5/8}

COLLECTION L

Finedining
Haute Porcelaine de Limoges
High Limoges Porcelain



DEGRENNE
LA MANUFACTURE
PORCELAINE DE LIMOGES
MADE IN FRANCE



BLANC
WHITE



ASSIETTE PLATE 237398
ROUND EXT : 32 CM - 12 IN^{5/8}
DINNER PLATE INT : 19,5 CM - 7 IN^{11/16}
W/WIDE RIM

237399
EXT : 28 CM - 11 IN
INT : 17 CM - 6 IN^{11/16}

237400
EXT : 24 CM - 9 IN^{7/16}
INT : 15 CM - 5 IN^{7/8}



Compatible with the shallow plate/cups

P 138-139



CLOCHE VERRE BOROSILICATE
DOME GLASS
COVER **204043**
17X9 CM
6 IN^{11/16} X 3 IN^{9/16}

BOUCHON PORCELAINE
PORCELAIN LID
206504
5,2 CM - 2 IN^{1/16}



ASSIETTE GOURMET 237402
ROUND EXT : 30 CM - 11 IN^{13/16}
SHALLOW BOWL INT : 14 CM - 5 IN^{1/2}
W/WIDE RIM

237403
EXT : 27,9 CM - 11 IN
INT : 11,5 CM - 4 IN^{1/2}



Compatible with the deep plate/cups

P 138-139

Compatible with the slanted plate/cups

P 138-139



CLOCHE INOX
DOME STAINLESS STEEL
COVER **182614**
24 CM - Ø 9 IN^{7/16}

182301
14,8 CM - Ø 5 IN^{13/16}



ASSIETTE À PAIN 237401
ROUND BREAD EXT : 14 CM - 5 IN^{1/2}
& BUTTER PLATE INT : 9,5 CM - 3 IN^{3/4}
W/WIDE RIM



TASSE 227828
ESPRESSO 10 CL - 3 OZ^{3/8}
DEMITASSE CUP 5,7 CM - 2 IN^{1/4}

SOUCOUPE 237404
ESPRESSO 12,6 CM
DEMITASSE Ø 4 IN^{5/16}
SAUCER



TASSE 227829
LUNGO 25 CL - 8 OZ^{7/16}
COFFEE/TEA CUP 8,5 CM - 3 IN^{3/8}

SOUCOUPE 237405
LUNGO 15,8 CM - Ø 6 IN^{1/4}
COFFEE/TEA SAUCER



COLLECTION L COUTURE

Finedining

Haute Porcelaine de Limoges
High Limoges Porcelain



MADE IN FRANCE



BLANC
WHITE

NOIR
BLACK



ASSIETTE PLATE 227843

ROUND EXT : 32 CM - 12 IN^{5/8}
DINNER PLATE INT : 19,5 CM - 7 IN^{11/16}
W/WIDE RIM

227844

EXT : 28 CM - 11 IN
INT : 17 CM - 6 IN^{11/16}

227845

EXT : 24 CM - 9 IN^{7/16}
INT : 15 CM - 5 IN^{7/8}

245599

EXT : 32 CM - 12 IN^{5/8}
INT : 19,5 CM - 7 IN^{11/16}

245601

EXT : 28 CM - 11 IN
INT : 17 CM - 6 IN^{11/16}

245603

EXT : 24 CM - 9 IN^{7/16}
INT : 15 CM - 5 IN^{7/8}

Compatible avec les assiettes cocottes
Compatible with the shallow plate/cups

P138-139

CLOCHE VERRE BOROSILICATE

DOME GLASS
COVER **204043**

17X9 CM
6 IN^{11/16} X 3 IN^{9/16}

BOUCHON PORCELAINE

PORCELAIN LID

206504
5,2 CM - 2 IN^{1/16}



ASSIETTE 227847

GOURMET EXT : 30 CM - 11 IN^{13/16}
ROUND INT : 14 CM - 5 IN^{1/2}

SHALLOW BOWL

W/WIDE RIM

227848

EXT : 27,9 CM - 11 IN
INT : 11,5 CM - 4 IN^{1/2}

245607

EXT : 30 CM - 11 IN^{13/16}
INT : 14 CM - 5 IN^{1/2}

Compatible avec les bols cocottes
Compatible with the deep plate/cups

P138-139

CLOCHE INOX

DOME STAINLESS STEEL
COVER **182614**

24 CM - Ø 9 IN^{7/16}

182301

14,8 CM - Ø 5 IN^{13/16}

Compatible avec les bols biseautés cocottes
Compatible with the slanted plate/cups

P138-139



ASSIETTE À PAIN 227846

ROUND BREAD EXT : 14 CM - 5 IN^{1/2}
& BUTTER PLATE INT : 9,5 CM - 3 IN^{3/4}
W/WIDE RIM

TASSE 227828

ESPRESSO 10 CL - 3 OZ^{3/8}
DEMITASSE CUP 5,7 CM - 2 IN^{1/4}

SOUCOUPE 227849

ESPRESSO 12,6 CM
DEMITASSE Ø 4 IN^{15/16}
SAUCER

TASSE 227829

LUNGO 25 CL - 8 OZ^{7/16}
COFFEE/TEA CUP 8,5 CM - 3 IN^{3/8}

SOUCOUPE 227850

LUNGO 15,8 CM - Ø 6 IN^{1/4}
COFFEE/TEA
SAUCER



COLLECTION L FRAGMENT

Finedining

Haute Porcelaine de Limoges
High Limoges Porcelain





ASSIETTE PLATE 233922
 ROUND EXT : 32 CM - 12 IN^{5/8}
 DINNER PLATE INT : 19,5 CM - 7 IN^{11/16}
 W/WIDE RIM

233923
 EXT : 28 CM - 11 IN
 INT : 17 CM - 6 IN^{11/16}

233924
 EXT : 24 CM - 9 IN^{7/16}
 INT : 15 CM - 5 IN^{7/8}



Compatible avec les assiettes cocottes
 Compatible with the shallow plate/cups

P138-139 ●●●●●●●●



CLOCHE VERRE BOROSILICATE
 DOME GLASS
 COVER **204043**

17X9 CM
 6 IN^{11/16} X 3 IN^{9/16}

BOUCHON PORCELAINE
 PORCELAIN LID
206504
 5,2 CM - 2 IN^{1/16}



ASSIETTE 233926
GOURMET EXT : 30 CM - 11 IN^{13/16}
 ROUND INT : 14 CM - 5 IN^{1/2}
 SHALLOW BOWL
 W/WIDE RIM

233927
 EXT : 27,9 CM - 11 IN
 INT : 11,5 CM - 4 IN^{1/2}



Compatible avec les bols cocottes
 Compatible with the deep plate/cups

P138-139 ●●●●●●●●

Compatible avec les bols biseautés cocottes
 Compatible with the slanted plate/cups

P138-139 ●●●●●●●●



CLOCHE INOX
 DOME STAINLESS STEEL
 COVER **182614**

24 CM - Ø 9 IN^{7/16}

182301
 14,8 CM - Ø 5 IN^{13/16}



ASSIETTE À PAIN 233925
 ROUND BREAD EXT : 14 CM - 5 IN^{1/2}
 & BUTTER PLATE INT : 9,5 CM - 3 IN^{3/4}
 W/WIDE RIM



TASSE 227828
ESPRESSO 10 CL - 3 OZ^{3/8}
 DEMITASSE CUP 5,7 CM - 2 IN^{1/4}

SOUCOUE 233928
ESPRESSO 12,6 CM
 DEMITASSE Ø 4 IN^{15/16}
 SAUCER



TASSE 227829
LUNGO 25 CL - 8 OZ^{7/16}
 COFFEE/TEA CUP 8,5 CM - 3 IN^{3/8}

SOUCOUE 233929
LUNGO 15,8 CM - Ø 6 IN^{1/4}
 COFFEE/TEA
 SAUCER



COLLECTION L PERLES DE ROSÉE

Finedining

Haute Porcelaine de Limoges
High Limoges Porcelain





ASSIETTE PLATE 234605
DINNER PLATE EXT : 32 CM - 12 IN^{5/8}
INT : 19 CM - 7 IN^{1/2}

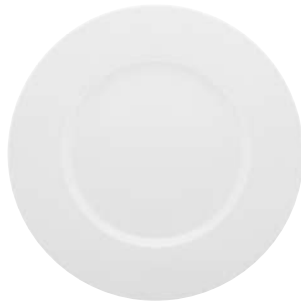

234612
EXT : 30 CM - 11 IN^{13/16}
INT : 18 CM - 7 IN^{1/16}



234607
EXT : 26,5 CM - 10 IN^{7/16}
INT : 17 CM - 6 IN^{11/16}



234608
EXT : 21,5 CM - 8 IN^{7/16}
INT : 13 CM - 5 IN^{1/8}



234603
EXT : 16 CM - 6 IN^{5/16}
INT : 10 CM - 3 IN^{15/16}



ASSIETTE CREUSE 234610
BORD À AILE EXT : 22,5 CM - 8 IN^{7/8}
ROUND DEEP PLATE INT : 13 CM - 5 IN^{1/8}



ASSIETTE CREUSE 234609
CALOTTE EXT : 19 CM - 7 IN^{1/2}
CEREAL PLATE INT : 12 CM - 4 IN^{3/4}



BOL À SALADE 234604
AVEC BORD À AILE 17,5 CM - 6 IN^{7/8}
SALAD BOWL WITH RIM

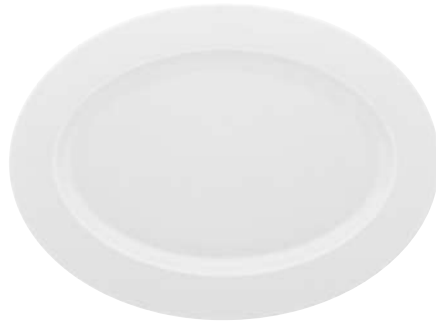

PLAT OVALE 234606
OVAL DISH 36,5 X 26,5 CM - 14 IN^{3/8} X 10 IN^{7/16}

ECLIPSE

Alldaydining

Porcelaine

Porcelain



MADE IN FRANCE



GALON OR
GOLD



ASSIETTE PLATE 241089
ROUND DINNER PLATE 32 CM - 12 IN^{5/8}

241090
26,5 CM - 10 IN^{7/16}

241091
21,5 CM - 8 IN^{7/16}



PLAT OVALE 241095
OVAL DISH 36,5 X 26,5 CM
14 IN^{3/8} X 10 IN^{7/16}



PLAT ROND PLAT 241096
ROUND CAKE/
PIE DISH 31,5 CM - 12 IN^{3/8}



ASSIETTE À PAIN 227886
ROUND BREAD PLATE 14 CM - 5 IN^{1/2}



ASSIETTE CREUSE 241092
CALOTTE RONDE 19 CM - 7 IN^{1/2}
ROUND
CEREAL PLATE



SALADIER 241098
SALAD BOWL 26 CM - 10 IN^{1/4}



ASSIETTE CREUSE 241097
À AILE RONDE 22,5 CM - 8 IN^{7/8}
ROUND
CEREAL PLATE



COUPELLE 241099
ROUND 13,5 CM - 5 IN^{5/16}
SMALL BOWL



TASSE À CAFÉ 241093
COFFEE CUP 10 CL - 3 OZ^{3/8}



TASSE À THÉ 247598
COFFEE/TEA CUP 25 CL - 8 OZ^{7/16}



TASSE DÉJEUNER 241102
BREAKFAST CUP 40 CL - 13 OZ^{1/2}

SOUCOUBE À CAFÉ 241094
COFFEE SAUCER 12,5 CM - Ø 4 IN^{15/16}

SOUCOUBE À THÉ 241105
COFFEE/TEA SAUCER 15 CM - Ø 5 IN^{7/8}

SOUCOUBE DÉJEUNER 241103
BREAKFAST SAUCER 19 CM - 7 IN^{1/2}



THÉIÈRE 241100
COFFEE/TEA POT 1L - 33 OZ^{13/16}



SUCRIER 241101
SUGAR BOWL 15 CL - 5 OZ^{1/16}



GALON OR

Finedining
Haute Porcelaine de Limoges
High Limoges Porcelain



GALON PLATINE
PLATINIUM



ASSIETTE PLATE 190054
ROUND DINNER PLATE 32 CM - 12 IN^{5/8}

190050
26,5 CM - 10 IN^{7/16}

190051
21,5 CM - 8 IN^{7/16}



PLAT OVALE 190069
OVAL DISH 36,5 X 26,5 CM
14 IN^{3/8} X 10 IN^{7/16}



PLAT ROND PLAT 190068
ROUND CAKE/ 31,5 CM - 12 IN^{3/8}
PIE DISH



ASSIETTE CREUSE 190052
CALOTTE RONDE 19 CM - 7 IN^{1/2}
ROUND
CEREAL PLATE



SALADIER 190071
SALAD BOWL 26 CM - 10 IN^{1/4}



ASSIETTE CREUSE 190053
À AILE RONDE 22,5 CM - 8 IN^{7/8}
ROUND
CEREAL PLATE



COUPELLE 190070
ROUND 13,5 CM - 5 IN^{5/16}
SMALL BOWL



TASSE À CAFÉ 203238
COFFEE CUP 10 CL - 3 OZ^{3/8}

SOUCOUPE À CAFÉ 203239
COFFEE SAUCER 12,5 CM - Ø 4 IN^{15/16}



TASSE À THÉ 247600
COFFEE/TEA CUP 25 CL - 8 OZ^{7/16}

SOUCOUPE À THÉ 203241
COFFEE/TEA SAUCER 15 CM - Ø 5 IN^{7/8}



TASSE DÉJEUNER 203242
BREAKFAST CUP 40 CL - 13 OZ^{1/2}

SOUCOUPE DÉJEUNER 203243
BREAKFAST SAUCER 19 CM - 7 IN^{1/2}



THÉIÈRE 203245
COFFEE/TEA POT 1 L - 33 OZ^{13/16}



SUCRIER 203250
SUGAR BOWL 15 CL - 5 OZ^{1/16}



GALON PLATINE

Finedining
Haute Porcelaine de Limoges
High Limoges Porcelain





ASSIETTE PLATE 247158 NEW
 ROUND 29,5 CM - 11 IN^{5/8}
 DINNER PLATE



ASSIETTE PLATE 247157
 ROUND 26 CM - 10 IN^{1/4}
 DINNER PLATE



ASSIETTE DESSERT 247163
 ROUND 21,5 CM - 8 IN^{7/16}
 DESSERT PLATE



ASSIETTE À PAIN 247160 NEW
 ROUND BREAD & BUTTER PLATE
 14 CM - 5 IN^{1/2}



ASSIETTE COUPE 247164
RONDE 19 CM - 7 IN^{1/2}
 SHALLOW COUPE BOL,
 MEDIUM



GRAND PLAT CREUX / 247159 NEW
ASSIETTE À PÂTES 31,5 CM
RONDE 12 IN^{3/16}
 SERVING DISH/
 ROUND PASTA PLATE

REMINISCENCE

Alldaydining
Haute Porcelaine de Limoges
High Limoges Porcelain



SD ONE BLANC
WHITE



ASSIETTE PLATE 241052
ROUND 32 CM - 12 IN^{5/8}
DINNER PLATE



241050
27 CM - 10 IN^{5/8}



241051
21,5 CM - 8 IN^{7/16}



ASSIETTE À PAIN 242916
ROUND 14 CM - 5 IN^{1/2}
BREAD PLATE



ASSIETTE COUPE 241048
SHALLOW COUPE 25 CM - 9 IN^{13/16}
BOWL, LARGE



241049
19 CM - 7 IN^{1/2}



BOL 241143
BOWL 14 CM - 5 IN^{1/2}
55 CL - 18 OZ^{5/8}



VERSEUSE 245885
MULTIPLE 13 CM - 4 IN^{3/8}
SAUCE JUG



TASSE ESPRESSO 242910
ESPRESSO CUP H 6,3 CM - 2 IN^{1/2}
Ø 6 CM - 2 IN^{3/8}
7 CL - 2 OZ^{3/8}



TASSE THÉ/CAFÉ 242912
TEA/COFFEE CUP H 8 CM - 3 IN^{1/8}
Ø 7,8 CM - 3 IN^{1/16}
15 CL - 5 OZ^{1/16}

SOUCOUPE 242914
SAUCER Ø 14 CM - 5 IN^{1/2}

SOUCOUPE 242914
SAUCER Ø 14 CM - 5 IN^{1/2}

SD ONE OR
GOLD



242547
32 CM - 12 IN^{5/8}



241053
27 CM - 10 IN^{5/8}



241054
21,5 CM - 8 IN^{7/16}



SD ONE

Finedining
Haute Porcelaine de Limoges
High Limoges Porcelain



SUPERNATURE
WHITE



ASSIETTE PLATE 242906
ROUND DINNER PLATE 32 CM - 12 IN^{5/8}



242330
27 CM - 10 IN^{5/8}



242331
21,5 CM - 8 IN^{7/16}



ASSIETTE 242907
À PAIN 14 CM - 5 IN^{1/2}
ROUND
BREAD PLATE

Compatible avec l'assiette coupe
de la collection SD ONE
Compatible with the plate
of SD ONE collection



ASSIETTE COUPE 241048
SHALLOW COUPE 25 CM - 9 IN^{13/16}
BOWL, LARGE



241049
19 CM - 7 IN^{1/2}

SUPERNATURE OR
GOLD



ASSIETTE 244121
PLATE 27 CM - 10 IN^{5/8}
ROUND
DINNER PLATE



ASSIETTE 244120
DESSERT 21,5 CM - 8 IN^{7/16}
ROUND
DESSERT PLATE



SUPERNATURE

Finedining
Haute Porcelaine de Limoges
High Limoges Porcelain



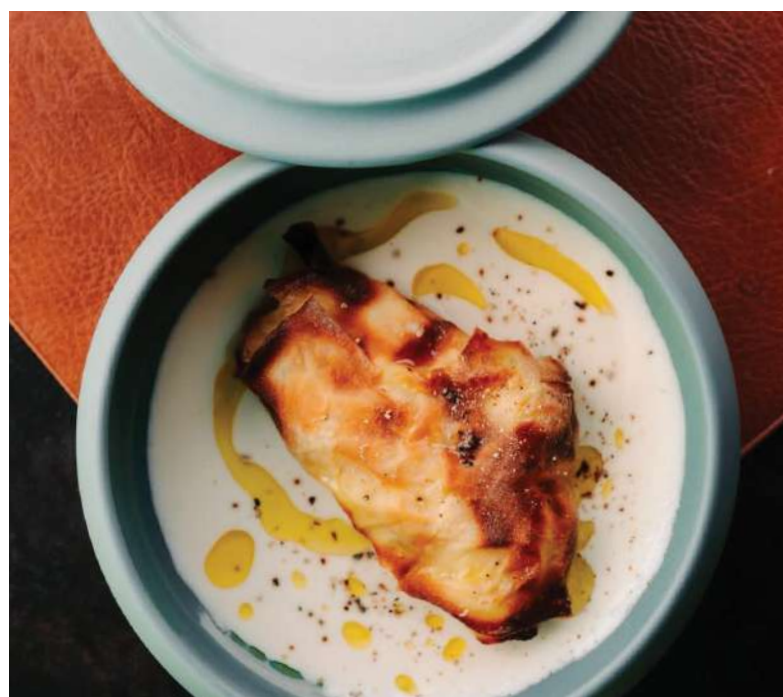

L'abus d'alcool est dangereux pour la santé
Alcohol abuse is dangerous for your health

LA CÉRAMIQUE

Ceramic

En porcelaine ou en grès, des iconiques COCOTTES jusqu'à nos assiettes COURONNE au décor en relief irisé posé à la main, nos collections de céramique mettent en avant les savoir-faire de notre Maison et se déclinent en une multitude de formats et de couleurs et s'adaptent à vos besoins pour dresser vos tables du quotidien ou des grandes occasions.

In porcelain or stoneware, from the iconic CUPS to our COURONNE plates, with hand-placed iridescent relief decoration. Our ceramic collections highlight the know-how of our House and are available in a multitude of formats and colors and adapt to your needs to set your tables for everyday life or special occasions.



PIERRE DE LUNE
MOONSTONE
Porcelaine - Porcelain



DUNE
BEIGE DUNE
Grès - Stoneware



BLEU DE ROCHE
BLUE STONE
Grès - Stoneware



ARGILE VERTE
GREEN CLAY
Grès - Stoneware



ONYX
BLACK ONYX
Grès - Stoneware

BAHIA

Alldaydining
Porcelaine - Grès
Porcelain - Stoneware

MADE IN EUROPE 



PIERRE DE LUNE
MOONSTONE
Porcelaine - Porcelain



ASSIETTE **239318**
PLATE
ROUND
DINNER PLATE
EXT : 29 CM - 11 IN^{7/16}
INT : 25,5 CM - 10 IN^{1/16}

239317
EXT : 26 CM - 10 IN^{1/4}
INT : 22 CM - 8 IN^{11/16}

239316
EXT : 23 CM - 9 IN^{1/16}
INT : 19,5 CM - 7 IN^{11/16}



ASSIETTE **239315**
À PAIN
ROUND
BREAD PLATE
EXT : 14 CM - 5 IN^{1/2}
INT : 10 CM - 3 IN^{15/16}



ASSIETTE **239319**
CREUSE
ROUND
CEREAL PLATE
45 CL - 15 OZ^{3/16}
EXT : 20 CM - 7 IN^{7/8}
INT : 16,5 CM - 6 IN^{1/2}



ASSIETTE **209384**
COUVERCLE
PLATE/CUP
12,5 CM - 4 IN^{15/16}



BOL **209720**
COCOTTE
DEEP PLATE/CUP
50 CL - 16 OZ^{15/16}
14 CM - 5 IN^{1/2}



BOL **211893** **211892**
BISEAUTÉ 30 CL - 10 OZ^{1/8} 7 CL - 2 OZ^{3/8}
COCOTTE 12 CM - 4 IN^{3/4} 7,3 CM - 2 IN^{7/8}
MINI CUP



ASSIETTE **239321**
GOURMET
ROUND
GOURMET
PLATE
GRAND BASSIN
W/WIDE ROUND RIM
EXT : 26 CM - 10 IN^{1/4}
INT : 14 CM - 5 IN^{1/2}

239320
PETIT BASSIN
W/WIDE ROUND RIM
EXT : 23 CM - 9 IN^{1/16}
INT : 11,5 CM - 4 IN^{1/2}

DUNE
BEIGE DUNE
Grés - Stoneware



230921
EXT : 29 CM - 11 IN^{7/16}
INT : 25,5 CM - 10 IN^{1/16}

230920
EXT : 26 CM - 10 IN^{1/4}
INT : 22 CM - 8 IN^{11/16}

230919
EXT : 23 CM - 9 IN^{1/16}
INT : 19,5 CM - 7 IN^{11/16}



230918
EXT : 14 CM - 5 IN^{1/2}
INT : 10 CM - 3 IN^{15/16}



230922
45 CL - 15 OZ^{3/16}
EXT : 20 CM - 7 IN^{7/8}
INT : 16,5 CM - 6 IN^{1/2}



230928
12,5 CM - 4 IN^{15/16}



230927 **247271** **NEW**
50 CL - 16 OZ^{15/16} (émaillée - enameled)
14 CM - 5 IN^{1/2}



230926 **230925**
30 CL - 10 OZ^{1/8} 7 CL - 2 OZ^{3/8}
12 CM - 4 IN^{3/4} 7,3 CM - 2 IN^{7/8}



230924
GRAND BASSIN
W/WIDE ROUND RIM
EXT : 26 CM - 10 IN^{1/4}
INT : 14 CM - 5 IN^{1/2}

230923
PETIT BASSIN
W/WIDE ROUND RIM
EXT : 23 CM - 9 IN^{1/16}
INT : 11,5 CM - 4 IN^{1/2}

BLEU DE ROCHE
BLUE STONE
Grés - Stoneware



230966
EXT : 29 CM - 11 IN^{7/16}
INT : 25,5 CM - 10 IN^{1/16}

230965
EXT : 26 CM - 10 IN^{1/4}
INT : 22 CM - 8 IN^{11/16}

230964
EXT : 23 CM - 9 IN^{1/16}
INT : 19,5 CM - 7 IN^{11/16}



230963
EXT : 14 CM - 5 IN^{1/2}
INT : 10 CM - 3 IN^{15/16}



230967
45 CL - 15 OZ^{3/16}
EXT : 20 CM - 7 IN^{7/8}
INT : 16,5 CM - 6 IN^{1/2}



230973
12,5 CM - 4 IN^{15/16}



230972 **247268** **NEW**
50 CL - 16 OZ^{15/16} (émaillée-enameled)
14 CM - 5 IN^{1/2}



230971 **230970**
30 CL - 10 OZ^{1/8} 7 CL - 2 OZ^{3/8}
12 CM - 4 IN^{3/4} 7,3 CM - 2 IN^{7/8}



230969
GRAND BASSIN
W/WIDE ROUND RIM
EXT : 26 CM - 10 IN^{1/4}
INT : 14 CM - 5 IN^{1/2}

230968
PETIT BASSIN
W/WIDE ROUND RIM
EXT : 23 CM - 9 IN^{1/16}
INT : 11,5 CM - 4 IN^{1/2}



ARGILE VERTE
GREEN CLAY
Grés - Stoneware



230952
EXT : 29 CM - 11 IN^{7/16}
INT : 25,5 CM - 10 IN^{1/16}

230951
EXT : 26 CM - 10 IN^{1/4}
INT : 22 CM - 8 IN^{11/16}

230950
EXT : 23 CM - 9 IN^{1/16}
INT : 19,5 CM - 7 IN^{11/16}



230949
EXT : 14 CM - 5 IN^{1/2}
INT : 10 CM - 3 IN^{15/16}



230953
45 CL - 15 OZ^{3/16}
EXT : 20 CM - 7 IN^{7/8}
INT : 16,5 CM - 6 IN^{1/2}



230959
12,5 CM - 4 IN^{15/16}



244138
BI FINITION-DUAL FINISH



230958
50 CL - 16 OZ^{15/16}
14 CM - 5 IN^{1/2}



247272 NEW
(émaillée - enameled)



230957
30 CL - 10 OZ^{1/8}
12 CM - 4 IN^{3/4}



230956
7 CL - 2 OZ^{3/8}
7,3 CM - 2 IN^{7/8}



230955
GRAND BASSIN
W/WIDE ROUND RIM
EXT : 26 CM - 10 IN^{1/4}
INT : 14 CM - 5 IN^{1/2}

230954
PETIT BASSIN
W/WIDE ROUND RIM
EXT : 23 CM - 9 IN^{1/16}
INT : 11,5 CM - 4 IN^{1/2}

ONYX
BLACK ONYX
Grés - Stoneware



236549
EXT : 29 CM - 11 IN^{7/16}
INT : 25,5 CM - 10 IN^{1/16}

236548
EXT : 26 CM - 10 IN^{1/4}
INT : 22 CM - 8 IN^{11/16}

236547
EXT : 23 CM - 9 IN^{1/16}
INT : 19,5 CM - 7 IN^{11/16}



236546
EXT : 14 CM - 5 IN^{1/2}
INT : 10 CM - 3 IN^{15/16}



236550
45 CL - 15 OZ^{3/16}
EXT : 20 CM - 7 IN^{7/8}
INT : 16,5 CM - 6 IN^{1/2}



236556
12,5 CM - 4 IN^{15/16}



236555
50 CL - 16 OZ^{15/16}
14 CM - 5 IN^{1/2}



247270 NEW
(émaillée - enameled)



236554
30 CL - 10 OZ^{1/8}
12 CM - 4 IN^{3/4}



236553
7 CL - 2 OZ^{3/8}
7,3 CM - 2 IN^{7/8}



236552
GRAND BASSIN
W/WIDE ROUND RIM
EXT : 26 CM - 10 IN^{1/4}
INT : 14 CM - 5 IN^{1/2}

236551
PETIT BASSIN
W/WIDE ROUND RIM
EXT : 23 CM - 9 IN^{1/16}
INT : 11,5 CM - 4 IN^{1/2}



ASSIETTE COUVERCLE
PLATE CUP

BOL COCOTTE
DEEP PLATE/CUP

ASSIETTE GOURMET
GRAND BASSIN
ROUND GOURMET PLATE
W/WIDE ROUND RIM



ASSIETTE GOURMET
PETIT BASSIN
ROUND GOURMET PLATE
W/WIDE ROUND RIM

BOL BISEAUTÉ COCOTTE
SLANTED PLATE/CUP



ACCESSOIRES ACCESSORIES

PIERRE DE LUNE
MOONSTONE
Porcelaine - Porcelain

DUNE
BEIGE DUNE
Grés - Stoneware

BLEU DE ROCHE
BLUE STONE
Grés - Stoneware

ONYX
BLACK ONYX
Grés - Stoneware

VERT ARGILE
GREEN CLAY
Grés - Stoneware



SALADIER 239325
LARGE DEEP 28 CM - 11 IN
PLATE/CUP



235223
28 CM - 11 IN



235222
28 CM - 11 IN



240499
28 CM - 11 IN



PLANCHE 242054
RECTANGULAIRE 35 x 21 CM
RECTANGULAR 13 IN^{3/4} x 8 IN^{1/4}
BOARD



242056
35 x 21 CM
13 IN^{3/4} x 8 IN^{1/4}



242052
35 x 21 CM
13 IN^{3/4} x 8 IN^{1/4}



237206
25 X 13,5 CM
9 IN^{13/16} X 5 IN^{5/16}



234949
25 X 13,5 CM
9 IN^{13/16} X 5 IN^{5/16}

234948
25 X 13,5 CM
9 IN^{13/16} X 5 IN^{5/16}

234950
25 X 13,5 CM
9 IN^{13/16} X 5 IN^{5/16}



PLANCHE 242055
RONDE 29 CM - 11 IN^{7/16}
ROUND BOARD



242057
29 CM - 11 IN^{7/16}



242053
29 CM - 11 IN^{7/16}



PLAT 241835
GRAND 31,8 x 25 x 7,4 CM
MODÈLE 12 IN^{1/2} x 9 IN^{13/16} x 2 IN^{15/16}
LARGE DISH



237595
31,8 x 25 x 7,4 CM
12 IN^{1/2} x 9 IN^{13/16} x 2 IN^{15/16}

PLAT 241834
MOYEN 22,8 x 16,2 x 5,4 CM
MODÈLE 9 IN x 6 IN^{3/8} x 2 IN^{1/8}
MEDIUM DISH

237594
22,8 x 16,2 x 5,4 CM
9 IN x 6 IN^{3/8} x 2 IN^{1/8}

PLAT 241833
PETIT 15,5 x 10,7 x 4,4 CM
MODÈLE 6 IN^{7/8} x 4 IN^{3/16} x 1 IN^{3/4}
SMALL DISH

237593
15,5 x 10,7 x 4,4 CM
6 IN^{7/8} x 4 IN^{3/16} x 1 IN^{3/4}





BLUE SHADES HALO
BLUE SHADES HALO



CODE EXPORT

ASSIETTE PLATE **240242**
ROUND DINNER PLATE EXT : 29 CM - 11 IN ^{7/16}

240243 **239655**
EXT : 26 CM - 10 IN ^{1/4}

240244 **239656**
EXT : 23 CM - 9 IN ^{1/16}

BLUE SHADES AQUARELLE
BLUE SHADES WATERCOLOR



239661
EXT : 26 CM - 10 IN ^{1/4}

239662
EXT : 23 CM - 9 IN ^{1/16}



CODE EXPORT

BOL COCOTTE **239658**
+ ASSIETTE/COUVERCLE 14 CM - 5 IN ^{1/2}
DEEP PLATE/CUP + 50 CL - 16 OZ ^{15/16}
ROUND PLATE
CUP **+240245** **239767**
12,5 CM - 4 IN ^{15/16}



BOL COCOTTE **239659**
DEEP PLATE/CUP 17,5 CM - 6 IN ^{7/8}
140 CL - 47 OZ ^{5/16}



BOL BISEAUTÉ COCOTTE **239660**
MINI CUP 7,5 CM - 2 IN ^{15/16}
7 CL - 2 OZ ^{3/8}



BOL À DÉJEUNER **239657**
BREAKFAST BOWL 14 CM - 5 IN ^{1/2}
55 CL - 18 OZ ^{5/8}



BLUE SHADES

Alldaydining

Porcelaine

Porcelain

MADE IN EUROPE





ASSIETTE PLATE 186770
RONDE 32,5 CM
 ROUND 12 IN^{5/8}
 DINNER PLATE
 W/WIDE RIM **186765**
 28,5 CM
 11 IN

186767
 22,5 CM
 8 IN^{7/8}



ASSIETTE 207140
À PÂTES/SOUPA EXT : 29,5 CM - 11 IN^{7/16}
 ROUND SOUP/PASTA INT : 17 CM - 6 IN^{11/16}
 BOWL W/WIDE RIM



ASSIETTE 207136
CALOTTE OVALE EXT : 23,5 X 20 CM
 OVAL 9 IN^{1/4} X 7 IN^{7/8}
 SHALLOW BOWL,
 COUPE



ASSIETTE À PAIN 187263
 ROUND 16 CM
 BREAD PLATE 6 IN^{5/16}
 W/WIDE RIM



ASSIETTE 246215
CREUSE 20 CM - 7 IN^{7/8}
 SHALLOW
 PLATE

NEW



MINI PLATEAU 159924
RECTANGULAIRE 16 X 12 CM -
 RECTANGULAR 6 IN^{5/16} X 4 IN^{3/4}
 SMALL DISH



ASSIETTE GOURMET 204040
OVALE GRAND BASSIN EXT : 32 X 27 CM - 12 IN^{5/8} X 10 IN^{5/8}
 SHALLOW BOWL INT : 14,5 CM - 5 IN^{5/16}
 W/WIDE OVAL RIM 27 CL - 9 OZ^{1/8}



Compatible avec les bols cocottes
 Compatible with the deep plate/cups



ASSIETTE GOURMET 207138
OVALE PETIT BASSIN EXT : 30 X 26 CM - 11 IN^{13/16} X 10 IN^{1/4}
 SHALLOW BOWL INT : 13,5 CM - 5 IN^{5/16}
 W/WIDE OVAL RIM 17 CL - 5 OZ^{3/4}

Compatible avec les bols biseautés cocottes
 Compatible with the slanted plate/cups



TASSE À CAFÉ 186791
 DEMITASSE CUP 9 CL - 3 OZ^{1/16}



TASSE À THÉ 186793
 COFFEE/TEA CUP 15 CL - 5 OZ^{1/16}



TASSE DÉJEUNER 186795
 BREAKFAST CUP 40 CL - 13 OZ^{1/2}

SOUCOUPE À CAFÉ 186792
OVALE 14X12 CM
 OVAL DEMITASSE Ø 5 IN^{1/2} X 4 IN^{3/4}
 SAUCER

SOUCOUPE À THÉ 186794
OVALE 16,5 X 14 CM
 OVAL COFFEE/TEA Ø 6 IN^{1/2} X 5 IN^{1/2}
 SAUCER

SOUCOUPE DÉJEUNER 186796
OVALE 20X17 CM
 OVAL BREAKFAST Ø 7 IN^{7/8} X 6 IN^{11/16}
 SAUCER



BORÉAL

Alldaydining

Porcelaine

Porcelain

MADE IN EUROPE





ASSIETTE PLATE 246871
RONDE 32,5 CM
 ROUND 12 IN^{5/8}
 DINNER PLATE
 W/WIDE RIM



246874
 28,5 CM
 11 IN



246877
 22,5 CM
 8 IN^{7/8}



CLOCHE VERRE BOROSILICATE
 DOME GLASS
 COVER **204043**
 17X9 CM
 6 IN^{11/16} X 3 IN^{9/16}

BOUCHON PORCELAINE
 PORCELAIN LID
206504
 5,2 CM - 2 IN^{1/16}



CLOCHE INOX
 DOME STAINLESS STEEL
 COVER **182614**
 24 CM - Ø 9 IN^{7/16}

182301
 14,8 CM - Ø 5 IN^{13/16}



BORÉAL ONDE

Finedining

Porcelaine

Porcelain

MADE IN EUROPE

NEW



BLANC
WHITE

DORÉ
GOLD

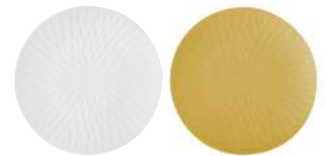
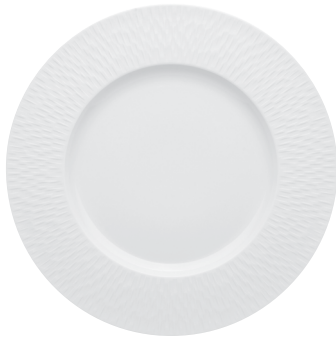

ASSIETTE PLATE 193319
DINNER PLATE EXT : 32,5 CM - 12 IN^{5/8}
W/WIDE RIM INT : 20 CM - 7 IN^{7/8}

225193

193318
EXT : 28,5 CM - 11 IN
INT : 18,5 CM - 7 IN^{5/16}

225194

193320
EXT : 22,5 CM - 8 IN^{7/8}
INT : 14,5 CM - 5 IN^{11/16}

225195

ASSIETTE 223954
À PÂTES/SOUBE EXT : 29 CM - 11 IN^{7/16}
ROUND SOUP/PASTA INT : 16 CM - 6 IN^{5/16}
BOWL W/WIDE RIM

ASSIETTE À PAIN 202470 225196
ROUND BREAD EXT : 15 CM
& BUTTER PLATE 5 IN^{7/8}
W/WIDE RIM



ASSIETTE GOURMET 207769
OVALE GRAND BASSIN EXT : 32 X 27 CM
SHALLOW BOWL 12 IN^{5/8} X 10 IN^{5/8}
W/WIDE OVAL RIM INT : 14,5 CM - 5 IN^{5/16}
27 CL - 9 OZ^{1/8}

Compatible avec les bols cocottes
Compatible with the deep plate/cups
P138-139

CLOCHE INOX 182614
DOME STAINLESS STEEL
COVER 24 CM - Ø 9 IN^{7/16}

ASSIETTE GOURMET 193324 225197
OVALE PETIT BASSIN EXT : 30 X 26 CM
SHALLOW BOWL 11 IN^{13/16} X 10 IN^{1/4}
W/WIDE OVAL RIM INT : 13,5 CM - 5 IN^{5/16}
17 CL - 5 OZ^{3/4}

Compatible avec les bols biseautés cocottes
Compatible with the slanted plate/cups
P138-139

182301
14,8 CM - Ø 5 IN^{13/16}



TASSE À CAFÉ 186791
DEMITASSE CUP 9 CL - 3 OZ^{1/16}

TASSE À THÉ 186793
COFFEE/TEA CUP 15 CL - 5 OZ^{1/16}

TASSE DÉJEUNER 186795
BREAKFAST CUP 40 CL - 13 OZ^{1/2}

SOUCOUBE 193321
À CAFÉ OVALE 14X12 CM
OVAL DEMITASSE Ø 5 IN^{1/2} X 4 IN^{3/4}
SAUCER

SOUCOUBE 193322
À THÉ OVALE 16,5 X 14 CM
OVAL COFFEE/TEA Ø 6 IN^{1/2} X 5 IN^{1/2}
SAUCER

SOUCOUBE 193323
DÉJEUNER OVALE 20X17 CM
OVAL BREAKFAST Ø 7 IN^{7/8} X 6 IN^{11/16}
SAUCER



BORÉAL SATIN

Finedining

Porcelaine

Porcelain

MADE IN EUROPE



L'abus d'alcool est dangereux pour la santé
Alcohol abuse is dangerous for your health

ROSÉE
PINK



ASSIETTE 241267
PLATE 26 CM - 10 IN^{1/4}
ROUND
DINNER
PLATE

SABLE
SAND



241275
26 CM - 10 IN^{1/4}

LAIT
WHITE MILK



244749
26 CM - 10 IN^{1/4}



241268
20 CM - 7 IN^{7/8}



241276
20 CM - 7 IN^{7/8}



244751
20 CM - 7 IN^{7/8}



BOL 241269
BOWL 20 CM - 7 IN^{7/8}
88 CL - 29 OZ^{3/4}



241277
20 CM - 7 IN^{7/8}
88 CL - 29 OZ^{3/4}



244753
20 CM - 7 IN^{7/8}
88 CL - 29 OZ^{3/4}



COUPELLE 241270
SMALL 12,5 CM - 4 IN^{15/16}
BOWL 23 CL - 7 OZ^{3/4}



241278
12,5 CM - 4 IN^{15/16}
23 CL - 7 OZ^{3/4}



244755
12,5 CM - 4 IN^{15/16}
23 CL - 7 OZ^{3/4}



BRUME

Alldaydining

Grès

Stoneware

MADE IN EUROPE



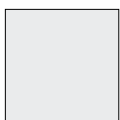

**BLANC
WHITE**

Porcelaine - Porcelain

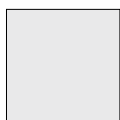

**BLANC SABLE
SANDY WHITE**

Porcelaine - Porcelain



**ONYX
BLACK ONYX**

Grés - Stoneware



**BLEU GOURMET
GOURMET BLUE**

Grés - Stoneware



**ROSE NUDE
PINK NUDE**

Grés - Stoneware



**DUNE
BEIGE DUNE**

Grés - Stoneware



**BLEU DE ROCHE
BLUE STONE**

Grés - Stoneware



**ARGILE VERTE
GREEN CLAY**

Grés - Stoneware

COCOTTES

Finedining

Porcelaine - Grès

Porcelain - Stoneware

MADE IN EUROPE



BLANC
WHITE
Porcelaine - Porcelain

BLANC SABLE
SANDY WHITE
Porcelaine - Porcelain

ONYX
BLACK ONYX
Grès - Stoneware

BLEU GOURMET
GOURMET BLUE
Grès - Stoneware

**ASSIETTE
COCOTTE (1)**
SHALLOW
PLATE/CUP
22 CM - 8 IN^{11/16}
100 CL - 33 OZ^{13/16}



234342



234345



243821



234339

**ASSIETTE
COCOTTE (2)**
SHALLOW
PLATE/CUP
18 CM - 7 IN^{7/16}
70 CL - 23 OZ^{11/16}



235064



235065



243830



235063

SALADIER
LARGE DEEP
PLATE/CUP
28 CM - 11 IN
4L - 135 OZ^{1/4}



239325



240499

**BOL
COCOTTE**
DEEP PLATE/CUP
17,5 CM - 6 IN^{7/8}
140 CL - 47 OZ^{5/16}



234341



234344



243803



234338

**BOL
COCOTTE (3)**
DEEP PLATE/CUP
14 CM - 5 IN^{1/2}
50 CL - 16 OZ^{15/16}



209383



209720



236555

247268 **NEW**
(émaillée-enameled)



230821



247269 **NEW**
(émaillée-enameled)

**ASSIETTE
COUVERCLE**
PLATE CUP
12,5 CM - 4 IN^{15/16}
18 CM - 7 IN^{7/16}



209384

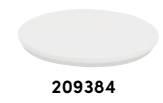

209384



236556

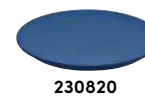

230820



245378



245378

**BOL BISEAUTÉ
COCOTTE**
SLANTED
PLATE/CUP
16 CM - 6 IN^{5/16}
100 CL - 33 OZ^{13/16}



234340



234343



234337

**BOL BISEAUTÉ
COCOTTE(4)**
SLANTED
PLATE/CUP
12 CM - 4 IN^{3/4}
30 CL - 10 OZ^{1/8}



186849



211893



236554



230822

**BOL BISEAUTÉ
COCOTTE**
MINI CUP
7,3 CM - 2 IN^{7/8}
7 CL - 2 OZ^{3/8}



211891



211892



236553



230823



(1) Compatible avec les assiettes de présentation
Compatible with the presentation plates



(2) Compatible avec les assiettes plates 28 cm
Compatible with the dinner plates 11 in

DUNE
BEIGE DUNE
Grés - Stoneware

BLEU DE ROCHE
BLUE STONE
Grés - Stoneware

ARGILE VERTE
GREEN CLAY
Grés - Stoneware

ROSE NUDE
PINK NUDE
Porcelaine - Porcelain

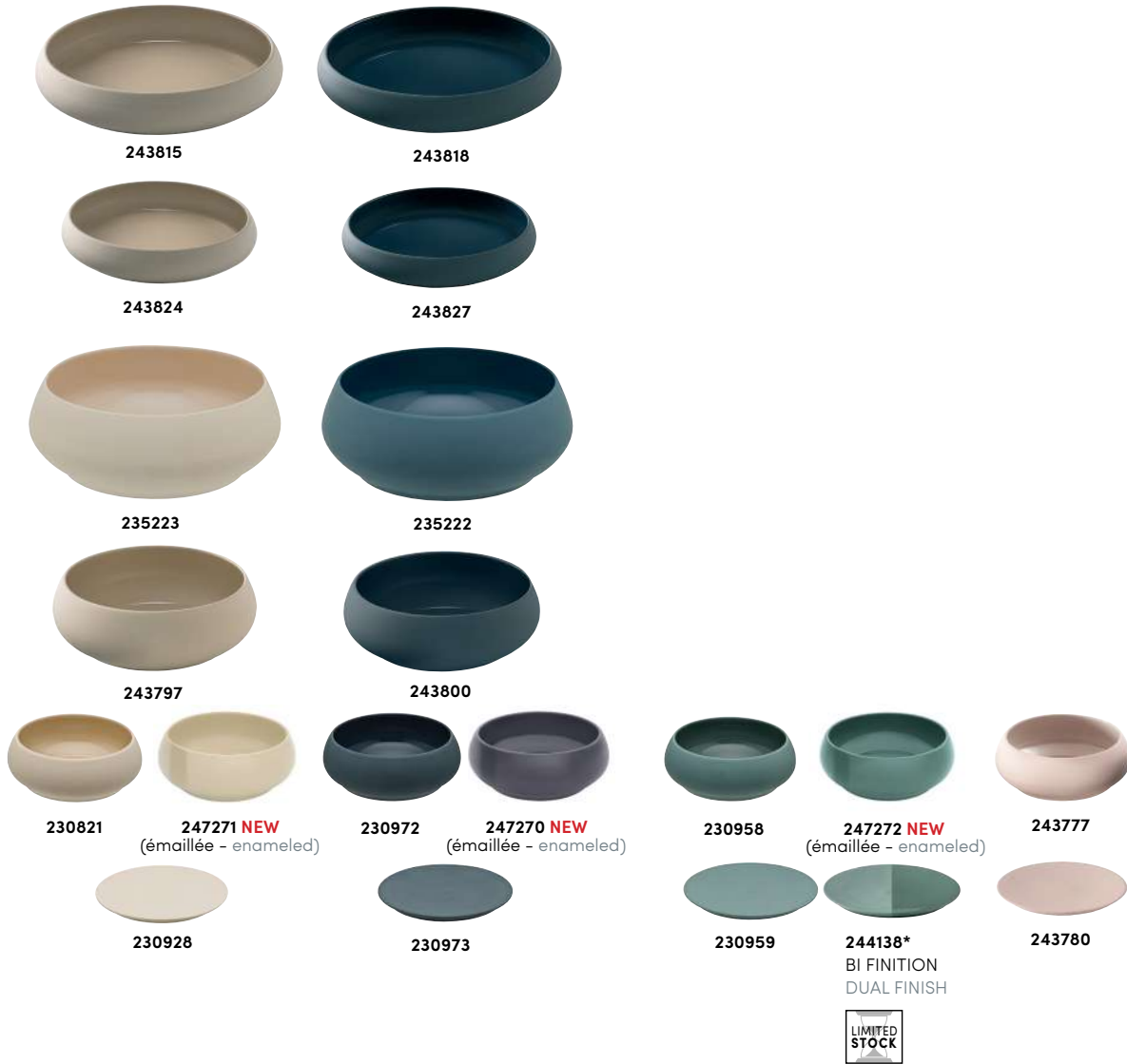

EMPILABLE - STACKABLE

*Arrêt à épuisement des stocks
Until stock limited



(3) Compatible avec les assiettes gourmet 30/32 cm
Compatible with the round shallow bowls 11 in^{12/15}/12 in^{5/8}

(4) Compatible avec les assiettes gourmet 28/30 cm
Compatible with the round shallow bowls 11 in/11 in^{13/16}





ASSIETTE 246704
PLATE 32 CM - 12 IN^{5/8}
 ROUND
 DINNER
 PLATE



246707
 29 CM - 11 IN^{7/16}



246710
 26 CM - 10 IN^{1/4}



ASSIETTE 246713
DESSERT 20 CM
 ROUND 7 IN^{7/8}
 DESSERT
 PLATE



ASSIETTE 246719
COUPE 24 CM - 9 IN^{7/16}
 SHALLOW COUPE
 BOWL, LARGE



ASSIETTE 246716
À PAIN 15 CM
 BREAD 5 IN^{7/8}
 BUTTER
 PLATE



CAFÉTERIE - COFFEEWARE
 P.178



PLAT OVALE 246721
 OVAL DISH 38X23,5 CM
 14 IN^{15/16} X 9 IN^{1/4}



BOL 247348
COCOTTE 14 CM - 50 CL
 CUP 5 IN^{1/2} - 16 OZ^{5/16}

ECLAT

Alldaydining
 Porcelaine - Collection éphémère
 Porcelain - Limited collection

MADE IN EUROPE

NEW



MINI PLATEAU 247109
RECTANGULAIRE 16 X 12 CM
 RECTANGULAR 6 in^{5/16} x 4 in^{3/4}
 MINI TRAY



MINI PLATEAU 247150
RECTANGULAIRE 16 X 12 CM
 RECTANGULAR 6 in^{5/16} x 4 in^{3/4}
 MINI TRAY



COURONNE DORÉE

Finedining

Porcelaine

Porcelain

MADE IN EUROPE

NEW



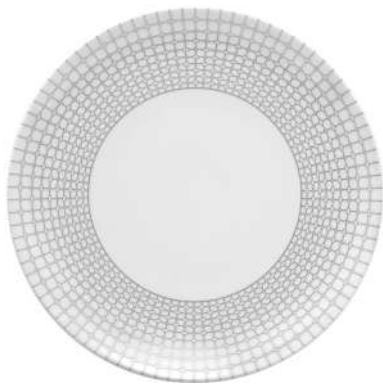

ASSIETTE 247230
PLATE 32 CM - 12 IN^{5/8}
 ROUND
 DINNER
 PLATE

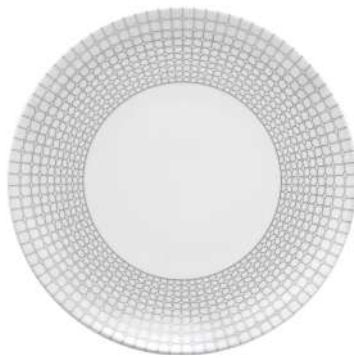

247229
 29 CM - 11 IN^{7/16}

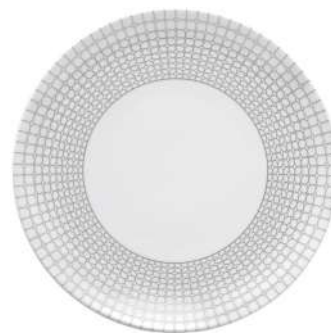

247228
 26 CM - 10 IN^{1/4}

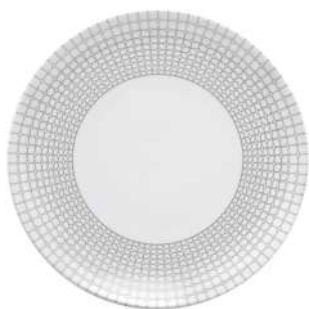

ASSIETTE 247231
DESSERT 20 CM
 7 IN^{7/8}
 ROUND
 DESSERT
 PLATE



ASSIETTE 247233
COUPE 24 CM - 9 IN^{7/16}
 SHALLOW COUPE
 BOWL, LARGE



ASSIETTE 247232
À PAIN 15 CM
 5 IN^{7/8}
 BREAD
 BUTTER
 PLATE



PLAT OVALE 247234
 OVAL DISH 38X23,5 CM
 14 IN^{15/16} X 9 IN^{1/4}



BOL 247344
COCOTTE 14 CM - 50 CL
 CUP 5 IN^{1/2} - 16 OZ^{5/16}



TASSE ESPRESSO 207756
 DEMITASSE CUP 10 CL - 3 OZ^{3/8}

SOUCOUPE ESPRESSO 247341
 DEMITASSE SAUCER 12,6 CM - Ø 4 IN^{5/16}



TASSE LUNGO 207757
 COFFEE/TEA CUP 20 CL - 6 OZ^{3/4}

SOUCOUPE LUNGO 247342
 COFFEE/TEA SAUCER 15,8 CM - Ø 5 IN^{7/8}



TASSE DÉJEUNER 207758
 BREAKFAST CUP 40 CL - 13 OZ^{1/2}

SOUCOUPE DÉJEUNER 247343
 BREAKFAST SAUCER 18 CM - 7 IN^{7/16}



COURONNE ARGENTÉ

Finedining

Porcelaine

Porcelain

MADE IN EUROPE

NEW



BLANC
WHITE

NEW
DORE
GOLD



ASSIETTE PLATE 245447

ROUND EXT : 32,5 CM - 12 IN^{13/16}
DINNER PLATE INT : 20 CM - 7 IN^{7/8}
W/WIDE RIM

245449

EXT : 28,5 CM - 11 IN^{1/4}
INT : 17 CM - 6 IN^{11/16}

245451

EXT : 22,5 CM - 8 IN^{7/8}
INT : 15 CM - 5 IN^{7/8}

246109

246110

246111



Compatible avec les assiettes cocottes
Compatible with the shallow plate/cups
P 138-139

CLOCHE VERRE BOROSILICATE

DOMES GLASS
COVER **204043**
17X9 CM
6 IN^{11/16} X 3 IN^{9/16}

BOUCHON PORCELAINE

PORCELAIN LID
206504
5,2 CM - 2 IN^{1/8}



ASSIETTE GOURMET 245457

OVALE GRAND BASSIN EXT : 32 X 27 CM - 12 IN^{5/8} X 10 IN^{5/8}
SHALLOW BOWL INT : 14,5 CM - 5 IN^{5/16}
W/WIDE OVAL RIM 27 CL - 9 OZ^{1/8}

246114

Compatible avec les bols cocottes
Compatible with the deep plate/cups
P 138-139

CLOCHE INOX

DOMES STAINLESS STEEL
COVER **182614**
24 CM - Ø 9 IN^{7/16}

ASSIETTE GOURMET 245455

OVALE PETIT BASSIN EXT : 30 X 26 CM - 11 IN^{13/16} X 10 IN^{1/4}
SHALLOW BOWL INT : 13,5 CM - 5 IN^{5/16}
W/WIDE OVAL RIM 17 CL - 5 OZ^{3/4}

246113

Compatible avec les bols biseautés cocottes
Compatible with the slanted plate/cups
P 138-139

182301

14,8 CM - Ø 5 IN^{13/16}



ASSIETTE 245741

À PÂTES/SOUBE EXT : 29,5 CM - 11 IN^{5/8}
ROUND SOUP/PASTA INT : 17 CM - 6 IN^{11/16}
BOWL W/WIDE RIM

246115

ASSIETTE À PAIN 245453

ROUND BREAD EXT : 15 CM - 5 IN^{7/8}
& BUTTER PLATE INT : 9,5 CM - 3 IN^{3/4}
W/WIDE RIM

246112



CAFÉTERIE - COFFEEWARE

NEW
P.178



GRAPHIQUE CLASSIQUE

Finedining
Porcelaine
Porcelain

MADE IN EUROPE 





ASSIETTE PLATE 237318
 ROUND 26 CM - 10 IN^{1/4}
 DINNER PLATE



237317
 24 CM - 9 IN^{7/16}



237316
 18 CM - 7 IN^{7/16}



237315
 14 CM - 5 IN^{1/2}



237321
BOL DROIT 24 CM - 9 IN^{7/16}
 STRAIGHT BOWL 2,6 L - 87 OZ^{15/16}



237320
 18 CM - 7 IN^{1/16}
 90 CL - 30 OZ^{7/16}



237319
 14 CM - 5 IN^{1/2}
 47 CL - 15 OZ^{7/8}



GRANDE 237324
ASSIETTE CREUSE 24 CM - 9 IN^{7/16}
 LARGE DEEP 1,3 L - 43 OZ^{15/16}
 PLATE



BOL COUPE 237323
 ROUNDED BOWL 18 CM - 7 IN^{1/16}
 90 CL - 30 OZ^{7/16}



237322
 14 CM - 5 IN^{1/2}
 47 CL - 15 OZ^{7/8}



LA VAISSELLE DE L'ÉCONOME

Alldaydining

Porcelaine
Porcelain

MADE IN EUROPE



ROND ROUND



ASSIETTE PLATE 207120
DINNER
COUPE PLATE
32 CM - 12 IN^{5/8}

207112
29 CM - 11 IN^{7/16}

207113
26 CM - 10 IN^{1/4}

207111
20 CM - 7 IN^{7/8}

207119
15 CM - 5 IN^{7/8}



ASSIETTE 207114
CREUSE/
CALOTTE
20 CM - 7 IN^{7/8}
ROUND
SHALLOW
BOWL



BOL 142722
DEEP
BOWL
28 CM - 11 IN
CONTENANCE : 2,5 L
CAPACITY : 84 OZ^{3/16}
H : 12 CM - 4 IN^{3/4}

136529
24 CM - 9 IN^{7/16}
CONTENANCE : 2 L
CAPACITY : 67 OZ^{5/8}
H : 11 CM - 4 IN^{1/4}

136511
20 CM - 7 IN^{7/8}
CONTENANCE : 1,30 L
CAPACITY : 43 OZ^{5/16}
H : 9,5 CM - 3 IN^{3/4}

136528
16 CM - 6 IN^{5/16}
CONTENANCE : 67 CL
CAPACITY : 22 OZ^{5/8}
H : 7,5 CM - 2 IN^{15/16}

154245
14 CM - 5 IN^{1/2}
CONTENANCE : 55 CL
CAPACITY : 18 OZ^{5/8}
H : 8 CM - 2 IN^{11/16}

136510
12 CM - 4 IN^{3/4}
CONTENANCE : 27 CL
CAPACITY : 9 OZ^{1/8}
H : 5,5 CM - 2 IN^{3/16}



COUPE 136535
SHALLOW
BOWL,
FOOTED
24 CM - 9 IN^{7/16}
H : 11 CM - 4 IN^{1/4}

136530
8 CM - 3 IN^{1/8}
H : 2,5 CM - 1 IN



ASSIETTE 246108
COUPE
RONDE
24 CM - 9 IN^{7/16}
ROUND
CEREAL
PLATE



MUG 234855 NEW
MUG 30 CL
11 OZ^{13/16}

ACCESSOIRES ACCESSORIES



PRÉSENTOIR 209382
À GÂTEAUX
ROUND
APP/PIZZA/
PRESENTATION
STAND
32 CM - 12 IN^{5/8}
H : 10,5 CM - 4 IN^{1/4}

209381
25 CM - 9 IN^{13/16}
H : 8,5 CM - 2 IN^{3/16}



CLOCHE 239771
EVENTO
Ø 28 CM - 11 IN
VERRE
EVENTO
239770
Ø 23 CM - 9 IN^{1/6}
DOME
COVER
239769
Ø 16 CM - 6 IN^{5/16}



PLAT À TARTE 136524
PIE/PIZZA 32 CM - 12 IN^{5/8}
PLATE,
FLAT



COFFRET 182915
SALIÈRE/
POIVRIÈRE
SALT & PEPPER
CRUET



MODULO

Alldaydining

Porcelaine

Porcelain

MADE IN EUROPE



CARRÉ SQUARE



ASSIETTE PLATE **207118**
SQUARE 28 CM - 11 IN
COUPE PLATE

207115
24 CM - 9 IN^{7/16}

207117
20 CM - 7 IN^{7/8}

207123
14 CM - 5 IN^{1/2}



COUPE **136502**
SQUARE BOWL,
FOOTED COUPE 12 CM - 4 IN^{3/4}
H : 3,5 CM - 1 IN^{3/8}

136503
8 CM - 3 IN^{1/8}
H : 2,5 CM - 1 IN

RECTANGLE RECTANGULAR



ASSIETTE PLATE **181485**
DINNER 34 X 26 CM
COUPE PLATE 13 IN^{3/8} X 10 IN^{1/4}

207122
30 X 22 CM
11 IN^{13/16} X 8 IN^{11/16}

207110
26 X 18 CM
10 IN^{1/4} X 7 IN^{1/16}



PLAT **207754**
RECTANGULAIRE 40 X 16 CM
RECTANGULAR DISH, 15 IN^{3/4} X 6 IN^{5/16}
COUPE LARGE

207753
20 X 12 CM
7 IN^{7/8} X 4 IN^{3/4}



SUPPORT **161036**
PLATEAU 30,5 X 10 CM
TRAY STAND, 12 IN X 3 IN^{5/16}
3 PLACES

NEWCOOK MODULO



RAMEQUIN **162015**
RAMEKIN 9,5 CM - 3 IN^{3/4}



ASSIETTE **162011**
À CRÈME 14 CM - 5 IN^{1/2}
BRÛLÉE
«CRÈME BRÛLÉE»
DISH



PLAT **164138**
À ESCARGOTS 16,6 X 11,2 CM -
6 PLACES 6 IN^{9/16} X 4 IN^{7/16}
SNAIL TRAY
6 SPACES







KAOLIN
KAOLIN



BLEU GALET
BLUE
NEW



PIERRE DE LAVE
LAVA STONE



TERRE D'OMBRE
TAUPE



JADE
GREEN JADE

MODULO NATURE

Alldaydining

Grès
Stoneware



PIERRE DE LAVE
LAVA STONE

KAOLIN
KAOLIN

JADE
JADE GREEN



ASSIETTE **194455**
PLATE 31,5 CM - 12 IN^{3/8}
ROUND

DINNER PLATE **194454**
27,9 CM - 11 IN

246750 **NEW**
26 CM - 10 IN^{1/4}

194453
21 CM - 8 IN^{1/4}

230092
16 CM - 6 IN^{5/16}

184088
31,5 CM - 12 IN^{3/8}

184077
27,9 CM - 11 IN

246751 **NEW**
26 CM - 10 IN^{1/4}

184078
21 CM - 8 IN^{1/4}

209092
16 CM - 6 IN^{5/16}

235681
31,5 CM - 12 IN^{3/8}

235682
27,9 CM - 11 IN

246753 **NEW**
26 CM - 10 IN^{1/4}

235683
21 CM - 8 IN^{1/4}

235685
16 CM - 6 IN^{5/16}



ASSIETTE **246755** **NEW**
COUPE 22 CM - 8 IN^{11/16}
SALAD/
CEREAL PLATE

246756 **NEW**
22 CM - 8 IN^{11/16}

246758 **NEW**
22 CM - 8 IN^{11/16}



ASSIETTE **194452**
CALOTTE 21 CM - 8 IN^{1/4}
SALAD/
CEREAL PLATE

184079
21 CM - 8 IN^{1/4}

235684
21 CM - 8 IN^{1/4}



COUPE **194457**
CALOTTE 17,7 CM - 6 IN^{5/16}
SALAD/
CEREAL PLATE
DEEP

184086
17,7 CM - 6 IN^{5/16}
H 5,5 CM - 2 IN^{3/16}

235687
17,7 CM - 6 IN^{5/16}
H 5,5 CM - 2 IN^{3/16}



COUPE RONDE **234455**
ROUND 25 CM - 9 IN^{13/16}
COUPE BOWL

234449
25 CM - 9 IN^{13/16}

235688
25 CM - 9 IN^{13/16}



TERRE D'OMBRE
TAUPE



184101
31,5 CM - 12 IN^{3/8}

184090
27,9 CM - 11 IN

246752 **NEW**
26 CM - 10 IN^{1/4}

184091
21 CM - 8 IN^{1/4}

209093
16 CM - 6 IN^{5/16}

BLEU GALET
BLUE
NEW



225342
31,5 CM - 12 IN^{3/8}

225343
27,9 CM - 11 IN

246747
26 CM - 10 IN^{1/4}

225344
21 CM - 8 IN^{1/4}

225353
16 CM - 6 IN^{5/16}



246757 **NEW**
22 CM - 8 IN^{11/16}



246748
22 CM - 8 IN^{11/16}



184092
21 CM - 8 IN^{1/4}



225345
21 CM - 8 IN^{1/4}



184099
17,7 CM - 6 IN^{15/16}
H 5,5 CM - 2 IN^{3/16}



225347
17,7 CM - 6 IN^{15/16}
H 5,5 CM - 2 IN^{3/16}



234451
25 CM - 9 IN^{13/16}



234457
25 CM - 9 IN^{13/16}

PIERRE DE LAVE
LAVA STONE



194462
SALADIER 24 CM - 9 IN^{7/16}
SALAD BOWL H 8 CM - 3 IN^{3/16}

KAOLIN
KAOLIN



184087
24 CM - 9 IN^{7/16}
H 8 CM - 3 IN^{3/16}

JADE
JADE GREEN



235689
24 CM - 9 IN^{7/16}
H 8 CM - 3 IN^{3/16}



246759 **NEW**
BOL 14,5 CM - 5 IN^{11/16}
BOWL



246760 **NEW**
14,5 CM - 5 IN^{11/16}



246762 **NEW**
14,5 CM - 5 IN^{11/16}



246759
BOL À DÉJEUNER
SOUP/ 14 CM - 5 IN^{11/16}
BREAKFAST BOWL 58 CL - 19 OZ^{5/8}



246760
14 CM - 5 IN^{11/16}
58 CL - 19 OZ^{5/8}



246762
14 CM - 5 IN^{11/16}
58 CL - 19 OZ^{5/8}



194458
COUPELLE
SMALL 10 CM - 3 IN^{15/16}
BOWL/CUP H 6 CM - 2 IN^{3/8}



184085
10 CM - 3 IN^{15/16}
H 6 CM - 2 IN^{3/8}



235686
10 CM - 3 IN^{15/16}
H 6 CM - 2 IN^{3/8}

CAFÉTERIE COFFEEWARE



194461
MUG 33 CL - 11 OZ^{3/16}
MUG



184083
33 CL - 11 OZ^{3/16}



246420 **NEW**
33 CL - 11 OZ^{3/16}



194459
TASSE À CAFÉ 11,5 CL - 3 OZ^{7/8}
DEMITASSE CUP



184081
11,5 CL - 3 OZ^{7/8}



235690
11,5 CL - 3 OZ^{7/8}

194460
SOUCOUPE À CAFÉ 12,5 CM - Ø 4 IN^{15/16}
DEMITASSE SAUCER

184082
12,5 CM - Ø 4 IN^{15/16}

235691
12,5 CM - Ø 4 IN^{15/16}

230093
TASSE À THÉ 25 CL - 8 OZ^{7/16}
TEA CUP

230163
25 CL - 8 OZ^{7/16}

235692
25 CL - 8 OZ^{7/16}

230094
SOUCOUPE À THÉ 15 CM - Ø 5 IN^{7/8}
DEMITASSE/TEA SAUCER

230164
15 CM - Ø 5 IN^{7/8}

235693
15 CM - Ø 5 IN^{7/8}



TERRE D'OMBRE
TAUPE



184100
24 CM - 9 IN^{7/16}
H 8 CM - 3 IN^{3/16}



246761 **NEW**
14,5 CM - 5 IN^{11/16}



246761
14 CM - 5 IN^{11/16}
58 CL - 19 OZ^{5/8}



184098
10 CM - 3 IN^{15/16}
H 6 CM - 2 IN^{3/8}



184096
33 CL - 11 OZ^{3/16}



184094
11,5 CL - 3 OZ^{7/8}

184095
12,5 CM - Ø 4 IN^{15/16}

230165
25 CL - 8 OZ^{7/16}

230166
15 CM - Ø 5 IN^{7/8}

BLEU GALET
BLUE
NEW



225349
24 CM - 9 IN^{7/16}
H 8 CM - 3 IN^{3/16}



246749
14,5 CM - 5 IN^{11/16}



246777
14 CM - 5 IN^{11/16}
58 CL - 19 OZ^{5/8}



225346
10 CM - 3 IN^{15/16}
H 6 CM - 2 IN^{3/8}



246746
33 CL - 11 OZ^{3/16}



225351
11,5 CL - 3 OZ^{7/8}

225352
12,5 CM - Ø 4 IN^{15/16}

230167
25 CL - 8 OZ^{7/16}

230168
15 CM - Ø 5 IN^{7/8}



ASSIETTE PLATE 243263
RONDE 32 CM - 12 IN^{5/8}
ROUND
DINNER
COUPE PLATE



243265
28 CM - 11 IN



243267
24 CM - 9 IN^{7/16}



ASSIETTE À PAIN 243269
ROUND 15 CM - 5 IN^{7/8}
BREAD PLATE



ASSIETTE 243271
COUPE RONDE 24 CM - 9 IN^{7/16}
ROUND
CEREAL PLATE



BOL 243273
DEEP 18 CM - 7 IN^{1/16}
BOWL



COUPELLE 243275
RONDE 13 CM - 5 IN^{1/8}



RIVAGE

Alldaydining

Porcelaine

Porcelain

MADE IN EUROPE





LA CAFÉTERIE

Teatime

Le thé et le café sont des univers où le plaisir des sens est décuplé par le plaisir esthétique. Pour rendre ces instants de dégustation uniques, DEGRENNE propose une large sélection de tasses et accessoires. Collection iconique de la marque depuis 1953, redécouvrez SALAM et réunissez tous les éléments pour maîtriser l'Art du Thé.

Drinking tea and coffee is a sensory delight heightened by the sheer aesthetic pleasure of the experience. DEGRENNE offers a wide range of cups and accessories to make tea and coffee drinking a unique experience. An iconic DEGRENNE collection since 1953 - why not seize the opportunity to rediscover SALAM and gather together the essentials needed to be skilled in the art of tea.

BLANCHE
WHITE

Cloche inox miroir - Mirror stainless steel lid



THÉIÈRE 211990
TEA POT 8 TASSES - 8 CUPS
130 CL - 43 OZ^{15/16}

211989
6 TASSES - 6 CUPS
100 CL - 33 OZ^{13/16}

211988
4 TASSES - 4 CUPS
70 CL - 23 OZ^{11/16}

211987
2 TASSES - 2 CUPS
35 CL - 11 OZ^{13/16}

NOIRE
BLACK

Cloche inox brossée - Brushed stainless steel lid



211994
8 TASSES - 8 CUPS
130 CL - 43 OZ^{15/16}

211993
6 TASSES - 6 CUPS
100 CL - 33 OZ^{13/16}

211992
4 TASSES - 4 CUPS
70 CL - 23 OZ^{11/16}

211991
2 TASSES - 2 CUPS
35 CL - 11 OZ^{13/16}

NOIRE
BLACK

Cloche aluminium noire mat - Black aluminium lid



216414
6 TASSES - 6 CUPS
100 CL - 33 OZ^{13/16}

216410
4 TASSES - 4 CUPS
70 CL - 23 OZ^{11/16}

243214
2 TASSES - 2 CUPS
35 CL - 11 OZ^{13/16}

ACCESSOIRES ACCESSORIES

BLANCHE
WHITE



CORPS 189949
THÉIÈRE 8 TASSES - 8 CUPS
TEA POT 130 CL - 43 OZ^{15/16}

189948
6 TASSES - 6 CUPS
100 CL - 33 OZ^{13/16}

189947
4 TASSES - 4 CUPS
70 CL - 23 OZ^{11/16}

189946
2 TASSES - 2 CUPS
35 CL - 11 OZ^{13/16}

NOIRE
BLACK



150447
8 TASSES - 8 CUPS
130 CL - 43 OZ^{15/16}

150456
6 TASSES - 6 CUPS
100 CL - 33 OZ^{13/16}

150455
4 TASSES - 4 CUPS
70 CL - 23 OZ^{11/16}

150450
2 TASSES - 2 CUPS
35 CL - 11 OZ^{13/16}



FEUTRE 217133
NOIR 8 TASSES - 8 CUPS
ISOLANT
BLACK
TEA POT **217132**
FELT 6 TASSES - 6 CUPS

217131
4 TASSES - 4 CUPS

217130
2 TASSES - 2 CUPS



BOUCHON 205136
THÉIÈRE 6/8 TASSES - 6/8 CUPS
TEA POT
LID **205135**
2/4 TASSES - 2/4 CUPS



210576
6/8 TASSES - 6/8 CUPS
210575
2/4 TASSES - 2/4 CUPS



INFUSEUR 240331
STAINLESS STEEL 6/8 TASSES - 6/8 CUPS
FILTER **240330**
4 TASSES - 4 CUPS



SUCRIER 187276
SUGAR BOWL 28 CL - 9 OZ^{7/16}



CORPS 187283
SUCRIER
SUGAR BOWL WITHOUT LID



150475 **150469**
28 CL - 9 OZ^{7/16}



150485
15 CL - 5 OZ^{1/16}

CRÉMIER 187277
CREAMER, JUG 15 CL - 5 OZ^{1/16}



SALAM

Alldaydining



ZINC
BLANC - WHITE



216416
6 TASSES - 6 CUPS
100 CL - 33 OZ^{13/16}

BRONZE
BLANC - WHITE



216415
6 TASSES - 6 CUPS
100 CL - 33 OZ^{13/16}

DORÉ - GOLDEN
BLANC - WHITE



234217
6 TASSES - 6 CUPS
100 CL - 33 OZ^{13/16}

BLEU - BLUE
BLANC - WHITE



225359
6 TASSES - 6 CUPS
100 CL - 33 OZ^{13/16}



216412
4 TASSES - 4 CUPS
70 CL - 23 OZ^{11/16}



216411
4 TASSES - 4 CUPS
70 CL - 23 OZ^{11/16}



234216
4 TASSES - 4 CUPS
70 CL - 23 OZ^{11/16}



225358
4 TASSES - 4 CUPS
70 CL - 23 OZ^{11/16}

BRONZE
NOIR - BLACK



237415
6 TASSES - 6 CUPS
100 CL - 33 OZ^{13/16}

EMERAUDE-EMERALD
NOIR - BLACK



240138
6 TASSES - 6 CUPS
100 CL - 33 OZ^{13/16}

ROUGE(Pomme d'amour) - RED
NOIR - BLACK



238935
6 TASSES - 6 CUPS
100 CL - 33 OZ^{13/16}

ROUGE(Pomme d'amour) - RED
BLANC - WHITE



238934
6 TASSES - 6 CUPS
100 CL - 33 OZ^{13/16}



237414
4 TASSES - 4 CUPS
70 CL - 23 OZ^{11/16}



240125
4 TASSES - 4 CUPS
70 CL - 23 OZ^{11/16}

OR - GOLD
BLANC - WHITE
Corps en porcelaine de Limoges
Limoges porcelain body



243794
4 TASSES - 4 CUPS
70 CL - 23 OZ^{11/16}

MONOCHROME BLANC
MONOCHROME WHITE
Cloche inox blanche - White stainless steel lid



242322
6 TASSES - 6 CUPS
100 CL - 33 OZ^{13/16}

MONOCHROME BLEU GOURMET
MONOCHROME GOURMET BLUE
Cloche inox bleue - Blue stainless steel lid



242324
6 TASSES - 6 CUPS
100 CL - 33 OZ^{13/16}

MONOCHROME ROSE NUDE
MONOCHROME PINK NUDE
Cloche inox rose nude - Pink nude stainless steel lid



242326
6 TASSES - 6 CUPS
100 CL - 33 OZ^{13/16}

MONOCHROME VERT AMANDE
MONOCHROME ALMOND GREEN
Cloche inox vert amande - Almond green stainless steel lid



242328
6 TASSES - 6 CUPS
100 CL - 33 OZ^{13/16}



242321
4 TASSES - 4 CUPS
70 CL - 23 OZ^{11/16}



242323
4 TASSES - 4 CUPS
70 CL - 23 OZ^{11/16}



242325
4 TASSES - 4 CUPS
70 CL - 23 OZ^{11/16}



242327
4 TASSES - 4 CUPS
70 CL - 23 OZ^{11/16}



SALAM MONOCHROME

Alldaydining



BLANC
WHITE
Porcelaine - Porcelain



TASSE ESPRESSO 242636
ESPRESSO CUP 10 CL - 3 OZ^{3/8}

BLEU GOURMET
GOURMET BLUE
Grès - Stoneware



242640
10 CL - 3 OZ^{3/8}

ROSE NUDE
PINK NUDE
Grès - Stoneware



242642
10 CL - 3 OZ^{3/8}

VERT AMANDE
ALMOND GREEN
Grès - Stoneware



242638
10 CL - 3 OZ^{3/8}



TASSE À THÉ 242628
CAPPUCCINO 25 CL - 8 OZ^{29/64}
TEA AND
CAPPUCCINO CUP



242632
25 CL - 8 OZ^{29/64}



242634
25 CL - 8 OZ^{29/64}



242630
25 CL - 8 OZ^{29/64}



TASSE À DÉJEUNER 242620
BREAKFAST CUP 39 CL - 13 OZ^{3/16}



242624
39 CL - 13 OZ^{3/16}



242626
39 CL - 13 OZ^{3/16}



242622
39 CL - 13 OZ^{3/16}



SOUCOUPE 242644
CÉRAMIQUE 15 CM - 5 IN^{7/8}
CERAMIC SAUCER



242648
15 CM - 5 IN^{7/8}



242650
15 CM - 5 IN^{7/8}



242646
15 CM - 5 IN^{7/8}

INOX
STAINLESS STEEL
MADE IN FRANCE



SOUCOUPE 242652
INOX 15 CM - 5 IN^{7/8}
STAINLESS
STEEL SAUCER



EMPILEO CAFETERIE

Alldaydining
C ramique
Ceramic

MADE IN EUROPE





TASSE À CAFÉ 210946
COFFEE/TEA POT 11 CL - 3 OZ^{3/4}



SOUCOUPE CAFÉ/THÉ 210950
DEMITASSE 16 CM - 6 IN^{5/16}
COFFEE/TEA SAUCER



TASSE À THÉ 210947
COFFEE/TEA POT 25 CL - 8 OZ^{7/16}

SOUCOUPE DÉJEUNER/ MUG 210951
BREAKFAST MUG 18 CM - 7 IN^{1/16}
SAUCER



TASSE À DÉJEUNER 210948
BREAKFAST CUP 42 CL - 14 OZ^{3/16}



MUG À THÉ 210949
TEA MUG 38 CL - 12 OZ^{7/8}

MODULO

Alldaydining

Porcelain

MADE IN EUROPE



NEW



MUG 234855
MUG 30 CL - 11 OZ^{13/16}



SALAM THÉ

Alldaydining

Porcelaine

Porcelain

MADE IN EUROPE



L



TASSE ESPRESSO 227828
DEMITASSE CUP 10 CL - 3 OZ^{3/8} - 5,7 CM - 2 IN^{1/4}

SOUCOUPE ESPRESSO 227831
DEMITASSE SAUCER 12,6 CM - Ø 4 IN^{15/16}



TASSE LUNGO 227829
COFFEE/TEA CUP 25 CL - 8 OZ^{7/16} - 8,5 CM - 3 IN^{3/8}

SOUCOUPE LUNGO 227832
COFFEE/TEA SAUCER 15,8 CM - Ø 6 IN^{1/4}

L COUTURE



TASSE ESPRESSO 227828
DEMITASSE CUP 10 CL - 3 OZ^{3/8} - 5,7 CM - 2 IN^{1/4}

SOUCOUPE ESPRESSO 237404
DEMITASSE SAUCER 12,6 CM - Ø 4 IN^{15/16}



TASSE LUNGO 227829
COFFEE/TEA CUP 25 CL - 8 OZ^{7/16} - 8,5 CM - 3 IN^{3/8}

SOUCOUPE LUNGO 237405
COFFEE/TEA SAUCER 15,8 CM - Ø 6 IN^{1/4}

L FRAGMENT

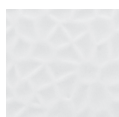

TASSE ESPRESSO 227828
DEMITASSE CUP 10 CL - 3 OZ^{3/8} - 5,7 CM - 2 IN^{1/4}

SOUCOUPE ESPRESSO 227849
DEMITASSE SAUCER 12,6 CM - Ø 4 IN^{15/16}



TASSE LUNGO 227829
COFFEE/TEA CUP 25 CL - 8 OZ^{7/16} - 8,5 CM - 3 IN^{3/8}

SOUCOUPE LUNGO 227850
COFFEE/TEA SAUCER 15,8 CM - Ø 6 IN^{1/4}

L PERLES DE ROSEE

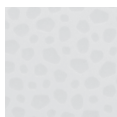

TASSE ESPRESSO 227828
DEMITASSE CUP 10 CL - 3 OZ^{3/8} - 5,7 CM - 2 IN^{1/4}

SOUCOUPE ESPRESSO 233928
DEMITASSE SAUCER 12,6 CM - Ø 4 IN^{15/16}



TASSE LUNGO 227829
COFFEE/TEA CUP 25 CL - 8 OZ^{7/16} - 8,5 CM - 3 IN^{3/8}

SOUCOUPE LUNGO 233929
COFFEE/TEA SAUCER 15,8 CM - Ø 6 IN^{1/4}

S D ONE



TASSE ESPRESSO 242910
ESPRESSO CUP H 6,3 CM - 2 IN^{1/2}
Ø 6 CM - 2 IN^{3/8}
7 CL - 2 OZ^{3/8}

SOUCOUPE 242914
SAUCER Ø 14 CM - 5 IN^{1/2}



TASSE THÉ/CAFÉ 242912
TEA/COFFEE CUP H 8 CM - 3 IN^{1/8}
Ø 7,8 CM - 3 IN^{1/16}
15 CL - 5 OZ^{1/16}

SOUCOUPE 242914
SAUCER Ø 14 CM - 5 IN^{1/2}

CAFÉTERIE COLLECTION L

Finedining

Haute Porcelaine de Limoges
High Limoges Porcelain



OR
GOLD



TASSE À CAFÉ 241093
COFFEE CUP 10 CL - 3 OZ^{3/8}

SOUCOUPE À CAFÉ 241094
COFFEE SAUCER 12,5 CM - Ø 4 IN^{15/16}



TASSE À THÉ 247598
COFFEE/TEA CUP 25 CL - 8 OZ^{7/16}

SOUCOUPE À THÉ 241105
COFFEE/TEA SAUCER 15 CM - Ø 5 IN^{7/8}



TASSE DÉJEUNER 241102
BREAKFAST CUP 40 CL - 13 OZ^{1/2}

SOUCOUPE DÉJEUNER 241103
BREAKFAST SAUCER 19 CM - 7 IN^{1/2}



THÉIÈRE 241100
COFFEE/TEA POT 1 L - 33 OZ^{13/16}



SUCRIER 241101
SUGAR BOWL 15 CL - 5 OZ^{1/16}

PLATINE
SILVER



TASSE À CAFÉ 203238
COFFEE CUP 10 CL - 3 OZ^{3/8}

SOUCOUPE À CAFÉ 203239
COFFEE SAUCER 12,5 CM - Ø 4 IN^{15/16}



TASSE À THÉ 247600
COFFEE/TEA CUP 25 CL - 8 OZ^{7/16}

SOUCOUPE À THÉ 203241
COFFEE/TEA SAUCER 15 CM - Ø 5 IN^{7/8}



TASSE DÉJEUNER 203242
BREAKFAST CUP 40 CL - 13 OZ^{1/2}

SOUCOUPE DÉJEUNER 203243
BREAKFAST SAUCER 19 CM - 7 IN^{1/2}



THÉIÈRE 203245
COFFEE/TEA POT 1 L - 33 OZ^{13/16}



SUCRIER 203250
SUGAR BOWL 15 CL - 5 OZ^{1/16}

CAFÉTERIE GALON

Finedining

Haute Porcelaine de Limoges
High Limoges Porcelain



BORÉAL



TASSE À CAFÉ 186791
DEMITASSE CUP 9 CL - 3 OZ^{1/16}

SOUCOUPE À CAFÉ 186792
DEMITASSE SAUCER 14X12 CM
Ø 5 IN^{1/2} X 4 IN^{3/4}



TASSE À THÉ 186793
COFFEE/TEA CUP 15 CL - 6 OZ^{3/4}

SOUCOUPE À THÉ 186794
COFFEE/TEA SAUCER 16,5 X 14 CM
Ø 6 IN^{1/2} X 5 IN^{1/2}



TASSE DÉJEUNER 186795
BREAKFAST CUP 40 CL - 13 OZ^{1/2}

SOUCOUPE DÉJEUNER 186796
BREAKFAST SAUCER 20X17 CM
Ø 7 IN^{7/8} X 6 IN^{11/16}

BORÉAL SATIN



TASSE À CAFÉ 186791
DEMITASSE CUP 9 CL - 3 OZ^{1/16}

SOUCOUPE À CAFÉ 193321
DEMITASSE SAUCER 14X12 CM
Ø 5 IN^{1/2} X 4 IN^{3/4}



TASSE À THÉ 186793
COFFEE/TEA CUP 15 CL - 6 OZ^{3/4}

SOUCOUPE À THÉ 193322
COFFEE/TEA SAUCER 16,5 X 14 CM
Ø 6 IN^{1/2} X 5 IN^{1/2}



TASSE DÉJEUNER 186795
BREAKFAST CUP 40 CL - 13 OZ^{1/2}

SOUCOUPE DÉJEUNER 193323
BREAKFAST SAUCER 20X17 CM
Ø 7 IN^{7/8} X 6 IN^{11/16}



CAFÉTERIE BORÉAL

Alldaydining

Porcelaine

Porcelain

MADE IN EUROPE



DORÉ
GOLD



TASSE ESPRESSO 207756
DEMITASSE CUP 10 CL - 3 OZ^{3/8}

SOUCOUPE ESPRESSO 247345
DEMITASSE SAUCER 12,6 CM - Ø 4 IN^{5/16}



TASSE LUNGO 207757
COFFEE/TEA CUP 20 CL - 6 OZ^{3/4}

SOUCOUPE LUNGO 247346
COFFEE/TEA SAUCER 15,8 CM - Ø 5 IN^{7/8}



TASSE DÉJEUNER 207758
BREAKFAST CUP 40 CL - 13 OZ^{1/2}

SOUCOUPE DÉJEUNER 247347
BREAKFAST SAUCER 18 CM - 7 IN^{7/16}

ARGENTÉ
SILVER



TASSE ESPRESSO 207756
DEMITASSE CUP 10 CL - 3 OZ^{3/8}

SOUCOUPE ESPRESSO 247341
DEMITASSE SAUCER 12,6 CM - Ø 4 IN^{5/16}



TASSE LUNGO 207757
COFFEE/TEA CUP 20 CL - 6 OZ^{3/4}

SOUCOUPE LUNGO 247342
COFFEE/TEA SAUCER 15,8 CM - Ø 5 IN^{7/8}



TASSE DÉJEUNER 207758
BREAKFAST CUP 40 CL - 13 OZ^{1/2}

SOUCOUPE DÉJEUNER 247343
BREAKFAST SAUCER 18 CM - 7 IN^{7/16}



CAFÉTERIE COURONNE

Finedining
Haute Porcelaine de Limoges
High Limoges Porcelain

MADE IN EUROPE

NEW



BLANC
WHITE

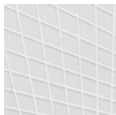

TASSE ESPRESSO 207756
DEMITASSE CUP 10 CL - 3 OZ^{3/8}



TASSE LUNGO 207757
COFFEE/TEA CUP 20 CL - 6 OZ^{3/4}



TASSE DÉJEUNER 207758
BREAKFAST CUP 40 CL - 13 OZ^{1/2}

SOUCOUPE ESPRESSO 246162
DEMITASSE SAUCER 12,6 CM - Ø 4 IN^{15/16}

SOUCOUPE LUNGO 246163
COFFEE/TEA SAUCER 15 CM - Ø 5 IN^{7/8}

SOUCOUPE DÉJEUNER 246268
BREAKFAST SAUCER 18 CM - 7 IN^{7/16}

DORÉ
GOLD
NEW



TASSE ESPRESSO 207756
DEMITASSE CUP 10 CL - 3 OZ^{3/8}



TASSE LUNGO 207757
COFFEE/TEA CUP 20 CL - 6 OZ^{3/4}



TASSE DÉJEUNER 207758
BREAKFAST CUP 40 CL - 13 OZ^{1/2}

SOUCOUPE ESPRESSO 246164
DEMITASSE SAUCER 12,6 CM - Ø 4 IN^{5/16}

SOUCOUPE LUNGO 246165
COFFEE/TEA SAUCER 15,8 CM - Ø 5 IN^{7/8}

SOUCOUPE DÉJEUNER 246269
BREAKFAST SAUCER 18 CM - 7 IN^{7/16}



CAFÉTERIE GRAPHIQUE CLASSIQUE

Alldaydining

Porcelaine
Porcelain

MADE IN EUROPE





TASSE ESPRESSO 207756
DEMITASSE CUP 10 CL - 3 OZ^{3/8}



TASSE LUNGO 207757
COFFEE/TEA CUP 20 CL - 6 OZ^{3/4}



TASSE DÉJEUNER 207758
BREAKFAST CUP 40 CL - 13 OZ^{1/2}

SOUCOUPE ESPRESSO 207759
DEMITASSE SAUCER 12,5 CM - Ø 4 IN^{5/16}

SOUCOUPE LUNGO 207760
COFFEE/TEA SAUCER 15,8 CM - Ø 5 IN^{7/8}

SOUCOUPE DÉJEUNER 207761
BREAKFAST SAUCER 18 CM - 7 IN^{7/8}



VERSEUSE 207764
COFFEE/TEA POT 80 CL - 27 OZ^{1/16}

207763
40 CL - 13 OZ^{1/2}



COUVERCLES 210912
VERSEUSES 8,4 CM - 3 IN^{5/16}
LIDS FOR 80 CL - 27 OZ^{1/16}
TEA POTS

210911
6,6 CM - 2 IN^{5/8}
40 CL - 13 OZ^{1/2}



CRÉMIER 207762
CREAM JUG 10 CL - 3 OZ^{3/8}



MUG 247354 NEW
MUG 20 CL - 6 OZ^{3/4}



NEWPORT
P 224

CAFÉTERIE NEWPORT

Finedining

Porcelaine

Porcelain

MADE IN EUROPE



PIERRE DE LAVE
LAVA STONE

KAOLIN
KAOLIN

BLEU GALET
BLUE
NEW

TERRE D'OMBRE
TAUPE

JADE
JADE GREEN



TASSE À CAFÉ 194459
DEMITASSE CUP 11,5 CL - 3 OZ^{7/8}

184081
11,5 CL - 3 OZ^{7/8}

225351
11,5 CL - 3 OZ^{7/8}

184094
11,5 CL - 3 OZ^{7/8}

235690
11,5 CL - 3 OZ^{7/8}

SOUCOUBE À CAFÉ 194460
DEMITASSE SAUCER 12,5 CM - Ø 4 IN^{15/16}

184082
12,5 CM - Ø 4 IN^{15/16}

225352
12,5 CM - Ø 4 IN^{15/16}

184095
12,5 CM - Ø 4 IN^{15/16}

235691
12,5 CM - Ø 4 IN^{15/16}



TASSE À THÉ 230093
TEA CUP 25 CL - 8 OZ^{7/16}

230163
25 CL - 8 OZ^{7/16}

230167
25 CL - 8 OZ^{7/16}

230165
25 CL - 8 OZ^{7/16}

235692
25 CL - 8 OZ^{7/16}

SOUCOUBE À THÉ 230094
DEMITASSE/TEA SAUCER 15 CM - Ø 5 IN^{7/8}

230164
15 CM - Ø 5 IN^{7/8}

230168
15 CM - Ø 5 IN^{7/8}

230166
15 CM - Ø 5 IN^{7/8}

235693
15 CM - Ø 5 IN^{7/8}



MUG 194461
MUG 33 CL - 11 OZ^{3/16}

184083
33 CL - 11 OZ^{3/16}

246746
33 CL - 11 OZ^{3/16}

184096
33 CL - 11 OZ^{3/16}

246420
33 CL - 11 OZ^{3/16}



MODULO NATURE

Alldaydining

Grès

Stoneware





LE VERRE

Glassware

Les collections de verres DEGRENNÉ invitent au partage et à la dégustation. Leurs qualités esthétiques ainsi que leur résistance exceptionnelle, garantissent une utilisation en toute occasion. Pour compléter harmonieusement la table, les verres de couleur DEGRENNÉ, teintés dans la masse, offrent une esthétique et une qualité à l'épreuve du temps et des lavages au lave-vaisselle.

DEGRENNÉ'S glassware collections are an invitation to socialize and enjoy a drink. Our glassware's looks and exceptional sturdiness mean that is suitable for any occasion. DEGRENNÉ's integrally dyed glasses are a harmonious addition to the dining table and offer looks and quality that withstand the test of time and repeated washing in the dishwasher.



LE VERRE À PIED

Stemmed glass



FLÛTE 242793
À CHAMPAGNE 26,1 CL
 CHAMPAGNE 8 OZ^{13/16}
 FLUTE Ø 7,25 CM
 H 24,5 CM
 Ø 2 IN^{7/8}
 H 9 IN^{5/8}



VERRE 242792
À PIED 40,5 CL
 STEMMED 13 OZ^{11/16}
 GLASS Ø 8,3 CM
 H 24,4 CM
 Ø 3 IN^{1/4}
 H 9 IN^{5/8}



VERRE 242791
À PIED 57 CL
 STEMMED 19 OZ^{1/4}
 GLASS Ø 9,6 CM
 H 25 CM
 Ø 3 IN^{3/4}
 H 9 IN^{13/16}



VERRE 242790
À BORDEAUX 64,5 CL
 BORDEAUX 21 OZ^{13/16}
 GLASS Ø 10,2 CM
 H 25,5 CM
 Ø 4 IN
 H 10 IN^{1/16}



VERRE 242789
À BOURGOGNE 71 CL
 BURGUNDY 24 OZ
 GLASS Ø 11,6 CM
 H 24,5 CM
 Ø 4 IN^{9/16}
 H 9 IN^{5/8}



GOBELET 242795
HAUT 39 CL - 13 OZ^{3/16}
 HIGH Ø 7 X H 14,4 CM
 TUMBLER Ø 2 IN^{3/4} X H 5 IN^{11/16}



GOBELET 242794
BAS 47 CL - 15 OZ^{7/8}
 LOW Ø 9,15 X H 10,85 CM
 TUMBLER Ø 3 IN^{5/8} X H 4 IN^{1/4}

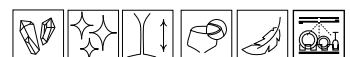

ALLURE

Finedining

MADE IN EUROPE 



L'abus d'alcool est dangereux pour la santé
Alcohol abuse is dangerous for your health



FLÛTE 184567
À CHAMPAGNE 15 CL
 CHAMPAGNE 5 OZ^{1/16}
 FLUTE Ø 6,3 CM
 H 19,3 CM
 Ø 2 IN^{1/2}
 H 7 IN^{5/8}



VERRE 184597
À CHAMPAGNE 21 CL
 CHAMPAGNE 7 OZ^{1/8}
 GLASS Ø 6,8 CM
 H 20,5 CM
 Ø 2 IN^{11/16}
 H 8 IN^{1/16}



COUPE 210281
À CHAMPAGNE 23 CL
 CHAMPAGNE 7 OZ^{3/4}
 GLASS Ø 9,5 CM
 H 14,7 CM
 Ø 3 IN^{3/4}
 H 5 IN^{13/16}



VERRE 195628
À MARTINI 25 CL
 MARTINI GLASS 8 OZ^{7/16}
 Ø 10,6 CM
 H 16,8 CM
 Ø 4 IN^{3/16}
 H 6 IN^{5/8}



VERRE 184570
À COGNAC 61 CL
 COGNAC 20 OZ^{5/8}
 GLASS Ø 10,4 CM
 H 15,5 CM
 Ø 4 IN^{1/8}
 H 6 IN^{1/8}

ORIGINE

POUR LES VINS MOELLEUX ET LIQUOREUX
 FOR SWEET & SYRUPY WINES
 PARA LOS VINOS MELOSOS
 Y LICOROSOS



VERRE N°5 216734*
 GLASS 20 CL
 6 OZ^{3/4}
 Ø 6,9 CM
 H 20 CM
 Ø 2 IN^{11/16}
 H 7 IN^{7/8}

***Arrêt à épuisement des stocks**
 Until stock limited



ANYTIME

Finedining

MADE IN EUROPE



L'abus d'alcool est dangereux pour la santé
Alcohol abuse is dangerous for your health



FLÛTE À 184566
CHAMPAGNE 19 CL
CHAMPAGNE 6 OZ^{7/16}
FLUTE Ø 5,3 CM
H 21,9 CM
Ø 2 IN^{1/16}
H 8 IN^{5/8}



VERRE 184562
À VIN ROUGE 37 CL
RED WINE 12 OZ^{1/2}
GLASS Ø 7,7 CM
H 21,4 CM
Ø 3 IN^{1/16}
H 8 IN^{7/16}



VERRE 184561
À EAU 49,5 CL
WATER 16 OZ^{3/4}
GLASS Ø 8,6 CM
H 22,7 CM
Ø 3 IN^{3/8}
H 8 IN^{15/16}



VERRE 184564
À BORDEAUX 65 CL
BORDEAUX 22 OZ
GLASS Ø 9,4 CM
H 23,9 CM
Ø 3 IN^{11/16}
H 9 IN^{7/16}



VERRE 184565
À BOURGOGNE 75 CL
BURGUNDY 25 OZ^{3/8}
GLASS Ø 10,7 CM
H 22,5 CM
Ø 4 IN^{3/16}
H 8 IN^{7/8}



DOMAINE

Finedining

MADE IN EUROPE





FLÛTE 184556
À CHAMPAGNE 20 CL - 6 OZ^{3/4}
CHAMPAGNE Ø 6,7 X H 21,2 CM
FLUTE Ø 2 IN^{5/8} X H 8 IN^{3/8}



VERRE 190537
À VIN 35 CL - 11 OZ^{3/16}
WINE GLASS Ø 7,8 X H 19,6 CM
Ø 3 IN^{1/16} X H 7 IN^{11/16}



VERRE 190536
À EAU 45 CL - 15 OZ^{2/16}
WATER GLASS Ø 8,4 X H 20,5 CM
Ø 3 IN^{5/16} X H 8 IN^{1/16}

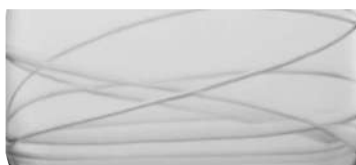

Décor taillé dans le verre
Cut-glass design



GOBELET 190538
TUMBLER 47 CL - 15 OZ^{7/8}
Ø 8,5 X H 12,1 CM
Ø 3 IN^{3/8} X H 4 IN^{3/4}



GALATEE

Finedining

MADE IN EUROPE 





FLÛTE 184580
À CHAMPAGNE 21 CL
 CHAMPAGNE 7 OZ^{1/8}
 FLUTE Ø 7 CM
 H 21 CM
 Ø 2 IN^{3/4}
 H 8 IN^{1/4}



VERRE 184577
À VIN BLANC 25 CL
 WHITE WINE 8 OZ^{7/16}
 GLASS Ø 7,5
 H 18,4 CM
 Ø 2 IN^{15/16}
 H 7 IN^{1/4}



VERRE 184576
À VIN ROUGE 32 CL
 RED WINE 10 OZ^{13/16}
 GLASS Ø 7,8 CM
 H 19,8 CM
 Ø 3 IN^{1/16}
 H 7 IN^{13/16}



VERRE 184575
À EAU 42 CL
 WATER GLASS 14 OZ^{3/16}
 Ø 8,7 CM
 H 20,5 CM
 Ø 3 IN^{7/16}
 H 8 IN^{1/16}



VERRE 184579
À BOURGOGNE 58 CL
 BURGUNDY GLASS 19 OZ^{5/8}
 Ø 10 CM
 H 20 CM
 Ø 3 IN^{15/16}
 H 7 IN^{7/8}

MONTMARTRE
 JAUGÉ



VERRE 208481
À VIN ROUGE 32 CL - 10 OZ^{13/16}
AVEC Ø 7,8 X H 19,8 CM
DOUBLE JAUGE Ø 3 IN^{1/16} X H 7 IN^{13/16}
 RED WINE GLASS
 WITH 2 GAUGES

HYPNOTIC
 JAUGÉ



213816
 36,5 CL - 13 OZ
 Ø 8,2 X H 22 CM
 Ø 3 IN^{1/4} X H 8 IN^{11/16}

Avec double jauge
 With 2 gauges

• 14 CL - 4 OZ^{3/4}
 • 12,5 CL - 4 OZ^{1/4}



MONTMARTRE

Alldaydining



L'abus d'alcool est dangereux pour la santé
Alcohol abuse is dangerous for your health



FLÛTE À 184551
CHAMPAGNE 19 CL
 CHAMPAGNE 6 OZ^{7/16}
 FLUTE Ø 6,3 CM
 H 22,4 CM
 Ø 2 IN^{1/2}
 H 8 IN^{13/16}



VERRE 184549
À VIN BLANC 28 CL
 WHITE WINE 9 OZ^{7/16}
 GLASS Ø 7,4 CM
 H 20,8 CM
 Ø 2 IN^{15/16}
 H 8 IN^{3/16}



VERRE 184548
À VIN ROUGE 35 CL
 RED WINE 11 OZ^{13/16}
 GLASS Ø 8 CM
 H 21,4 CM
 Ø 3 IN^{1/8}
 H 8 IN^{7/16}



VERRE 184547
À EAU 45 CL
 WATER 15 OZ^{3/16}
 GLASS Ø 8,4 CM
 H 22,5 CM
 Ø 3 IN^{5/16}
 H 8 IN^{1/16}



VERRE 184550
À BORDEAUX 64,5 CL
 BORDEAUX 21 OZ^{13/16}
 GLASS Ø 9,5 CM
 H 23,8 CM
 Ø 3 IN^{3/4}
 H 9 IN^{3/8}



VERRE 210812
À BOURGOGNE 70 CL
 BURGUNDY 23 OZ^{11/16}
 GLASS Ø 10,5 CM
 H 23,1 CM
 Ø 4 IN^{1/8}
 H 9 IN^{1/8}



GOBELET 184555
HAUT 36 CL - 12 OZ^{3/16}
 HIGH Ø 6,8 X H 14,2 CM
 TUMBLER Ø 2 IN^{11/16} X H 5 IN^{9/16}



GOBELET 184554
BAS 33 CL - 11 OZ^{3/16}
 LOW Ø 8 X H 10,2 CM
 TUMBLER Ø 3 IN^{1/8} X H 4 IN

184553
 23 CL - 7 OZ^{3/4}
 Ø 7,6 X H 9,2 CM
 Ø 3 IN X H 3 IN^{5/8}



MUSE

Finedining

MADE IN EUROPE 



L'abus d'alcool est dangereux pour la santé
Alcohol abuse is dangerous for your health



CARAFE 242961*
 CARAFE 25 CL - 8 OZ^{7/16}
 18 CM
 7 IN^{1/16}

*Arrêt à épuisement des stocks
 Until stock limited



COUPE À GLACE/ 244053*
COCKTAIL 28 CL
 COCKTAIL/ICE 9 OZ^{7/16}
 CUP GLASS Ø 11,3 CM
 H 14,4 CM
 Ø 4 IN^{7/16}
 H 5 IN^{11/16}



VERRE 244055*
À LIQUEUR 7,5 CL
 BURGUNDY 2 OZ^{9/16}
 GLASS Ø 7,1 CM
 H 11 CM
 Ø 2 IN^{13/16}
 H 4 IN^{5/16}



VERRINE 244047*
APÉRITIF 27 CL - 9 OZ^{1/8}
 VERRINE Ø 9,3 X H 6 CM
 APPETIZER Ø 3 IN^{11/16} X H 2 IN^{3/8}



GOBELET 244061*
HAUT 37 CL - 12 OZ^{1/2}
 HIGH Ø 6,5 X H 16 CM
 DRINK Ø 2 IN^{9/16} X H 6 IN^{5/16}



CARAFE 244910*
 CARAFE 100 CL - 33 OZ^{13/16}
 Ø 8,8 X H 28,3 CM
 Ø 3 IN^{7/16} X H 11 IN^{1/8}

*Arrêt à épuisement des stocks
 Until stock limited



NEWPORT TWIST

Finedining

MADE IN EUROPE



L'abus d'alcool est dangereux pour la santé
Alcohol abuse is dangerous for your health



The image features four pieces of clear glassware with a textured, pebbled surface. On the left is a tall, slender tumbler. To its right is a shorter, wider tumbler. In the foreground on the right is a carafe with a flared base. A fourth piece is partially visible at the top left. The items are set against a plain white background with soft shadows cast to the right.

GOBELET ET CARAFE

Tumbler & Carafe

ROUGE
RED



GOBELET **225516**
TUMBLER 29 CL - 9 OZ^{13/16}
Ø 7,2 X H 9,5 CM
Ø 2 IN^{13/16} X H 3 IN^{3/4}

NOIR
BLACK



180936
29 CL - 9 OZ^{13/16}
Ø 7,2 X H 9,5 CM
Ø 2 IN^{13/16} X H 3 IN^{3/4}

CASSIS
PURPLE



174510
29 CL - 9 OZ^{13/16}
Ø 7,2 X H 9,5 CM
Ø 2 IN^{13/16} X H 3 IN^{3/4}

TRANSPARENT
TRANSPARENT



206936
29 CL - 9 OZ^{13/16}
Ø 7,2 X H 9,5 CM
Ø 2 IN^{13/16} X H 3 IN^{3/4}

GRIS
GREY



225517
29 CL - 9 OZ^{13/16}
Ø 7,2 X H 9,5 CM
Ø 2 IN^{13/16} X H 3 IN^{3/4}

BLEU NUIT
BLUE NIGHT



199461
29 CL - 9 OZ^{13/16}
Ø 7,2 X H 9,5 CM
Ø 2 IN^{13/16} X H 3 IN^{3/4}

BLANC
WHITE



180939
29 CL - 9 OZ^{13/16}
Ø 7,2 X H 9,5 CM
Ø 2 IN^{13/16} X H 3 IN^{3/4}

VERRE SOUFLÉ BOUCHE TEINTÉ DANS LA MASSE
HAND-BLOWN INTEGRALLY DYED GLASS



ALLEGRO

Alldaydining



L'abus d'alcool est dangereux pour la santé
Alcohol abuse is dangerous for your health



GOBELET 184589
HAUT 35 CL - 11 OZ^{13/16}
 HIGH Ø 6,5 X H 14,4 CM
 TUMBLER Ø 2 IN^{9/16} X H 5 IN^{11/16}



GOBELET 184588
HAUT 29 CL - 9 OZ^{13/16}
 HIGH Ø 7 X H 10,7 CM
 TUMBLER Ø 2 IN^{3/4} X H 4 IN^{3/16}



GOBELET 189774
BAS 42 CL - 14 OZ^{3/16}
 LOW Ø 8,5 X H 10,6 CM
 TUMBLER Ø 3 IN^{3/8} X H 4 IN^{3/16}



GOBELET 184586
BAS 32 CL - 10 OZ^{13/16}
 LOW Ø 8 X H 9,4 CM
 TUMBLER Ø 3 IN^{1/8} X H 3 IN^{11/16}



GOBELET 169851
HAUT 57 CL - 19 OZ^{1/4}
 HIGH Ø 6,7 X H 11,5 CM
 TUMBLER Ø 2 IN^{5/8} X H 4 IN^{1/2}



GOBELET 169852
BAS 43 CL - 14 OZ^{29/16}
 LOW Ø 6,1 X H 10 CM
 TUMBLER Ø 2 IN^{3/8} X H 3 IN^{15/16}



COSMOPOLITAIN

All day dining

MADE IN EUROPE



DOLCE

Fine dining



L'abus d'alcool est dangereux pour la santé
Alcohol abuse is dangerous for your health

TRANSPARENT
TRANSPARENT



VERRE 234149
À PIED 26 CL - 8 OZ^{13/16}
STEMMED Ø 7,9 X H 11,1 CM
GLASS Ø 3 IN^{1/8} X H 4 IN^{3/8}

BLEU
BLUE



236287
26 CL - 8 OZ^{13/16}
Ø 7,9 X H 11,1 CM
Ø 3 IN^{1/8} X H 4 IN^{3/8}

GRIS
GREY



242555
26 CL - 8 OZ^{13/16}
Ø 7,9 X H 11,1 CM
Ø 3 IN^{1/8} X H 4 IN^{3/8}

VERT
GREEN



GOBELET 234150
TUMBLER 26 CL - 8 OZ^{13/16}
Ø 7,1 X H 9,1 CM
Ø 2 IN^{13/16} X H 3 IN^{9/16}



236289
26 CL - 8 OZ^{13/16}
Ø 7,1 X H 9,1 CM
Ø 2 IN^{13/16} X H 3 IN^{9/16}



242554
26 CL - 8 OZ^{13/16}
Ø 7,1 X H 9,1 CM
Ø 2 IN^{13/16} X H 3 IN^{9/16}



242552
26 CL - 8 OZ^{13/16}
Ø 7,1 X H 9,1 CM
Ø 2 IN^{13/16} X H 3 IN^{9/16}



CARAFE 234148
EMPILEO 75 CL - 25 OZ^{3/8}
PITCHER Ø 9,1 X H 24 CM
Ø 3 IN^{9/16} X H 4 IN^{3/8}



236288
75 CL - 25 OZ^{3/8}
Ø 9,1 X H 24 CM
Ø 3 IN^{9/16} X H 4 IN^{3/8}



EMPILEO

Alldaydining



L'abus d'alcool est dangereux pour la santé
Alcohol abuse is dangerous for your health

INSTANT

Alldaydining



243495*
32 CL - 10 OZ^{13/16}
Ø 6 X H 13,7 CM
Ø 2 IN^{3/8} X H 5 IN^{3/8}

*Arrêt à épuisement des stocks
Until stock limited



LOOP

Alldaydining



GOBELET 184601
HAUT 39 CL - 13 OZ^{3/16}
HIGH Ø 6,6 X H 14,5 CM
TUMBLER Ø 2 IN^{5/8} X H 5 IN^{11/16}



GOBELET 184600
BAS 35 CL - 11 OZ^{13/16}
LOW Ø 7,9 X H 9,1 CM
TUMBLER Ø 3 IN^{1/8} X H 3 IN^{9/16}



GOBELET BAS/ 184598
VERRINE 19 CL - 6 OZ^{7/16}
LOW TUMBLER/ Ø 6,7 X H 8,1 CM
APPETIZER GLASS Ø 2 IN^{5/8} X H 3 IN^{3/16}

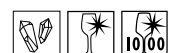

MAMBO

Alldaydining

GRIS
GREY



GOBELET 171631
TUMBLER 34 CL - 11 OZ^{1/2}
Ø 8,5 X H 10 CM
Ø 3 IN^{3/8} X H 3 IN^{15/16}

VERT
GREEN



171632
34 CL - 11 OZ^{1/2}
Ø 8,5 X H 10 CM
Ø 3 IN^{3/8} X H 3 IN^{15/16}

ROUGE
RED



171630
34 CL - 11 OZ^{1/2}
Ø 8,5 X H 10 CM
Ø 3 IN^{3/8} X H 3 IN^{15/16}



ROC

Alldaydining



VERRE 236340
À PIED 27 CL - 9 OZ^{1/8}
STEMMED Ø 7,2 X H 11,5 CM
GLASS Ø 3 IN^{13/16} X H 4 IN^{1/2}



GOBELET 236338
BAS 18 CL - 6 OZ^{1/16}
LOW Ø 7,2 X H 6,5 CM
TUMBLER Ø 2 IN^{13/16} X H 2 IN^{3/8}



GOBELET 236339
HAUT 45 CL - 15 OZ^{3/16}
HIGH Ø 7,2 X H 14 CM
TUMBLER Ø 2 IN^{13/16} X H 5 IN^{1/2}



TRANSPARENT
TRANSPARENT



CARAFE 234148
EMPILEO 75 CL - 25 OZ^{3/8}
PITCHER Ø 9,1 X H 24 CM
Ø 3 IN^{9/16} X H 4 IN^{3/8}

BLEU
BLUE



236288
75 CL - 25 OZ^{3/8}
Ø 9,1 X H 24 CM
Ø 3 IN^{9/16} X H 4 IN^{3/8}



CARAFE À JUS 202639
DE FRUITS 1,2 L - 40 OZ^{9/16}
EVENTO Ø 10,5 X H 27,5 CM
JUICE/ Ø 4 IN^{1/8} X H 10 IN^{13/16}
BEVERAGE
CARAFE



BOUCHON DE 202855
CARAFE Ø 6,5 CM - 2 IN^{9/16}
SILICONE
EVENTO
SILICONE
STOPPER
FOR CARAFE



CARAFE 242961*
NEWPORT TWIST 25 CL - 8 OZ^{7/16}
CARAFE 18 CM
7 IN^{1/16}



CARAFE 244910*
NEWPORT 100 CL - 33 OZ^{13/16}
TWIST Ø 8,8 X H 28,3 CM
CARAFE Ø 3 IN^{7/16} X H 11 IN^{1/8}



DECANTEUR 169728
MILLÉSIME 1,35 L - 45 OZ^{5/8}
DECANTER Ø 20,5 X H 23,5 CM
Ø 8 IN^{1/16} X H 9 IN^{1/4}



DECANTEUR 210904
NECTAR 1 L - 33 OZ^{13/16}
DECANTER Ø 13,5 X H 24,5 CM
Ø 5 IN^{5/16} X H 9 IN^{5/8}

*Arrêt à épuisement des stocks
Until stock limited



CARAFES - DÉCANTEURS





LA PLATERIE

Holloware

A travers des objets en acier dédiés à la table, au service et à la dégustation, DEGRENNE exprime à travers ses collections de platerie toute la richesse de son métier d'orfèvre.

DEGRENNE expresses its highly-varied metal-working expertise through steel products designed for the table, service and tasting and appreciating.

PLATEAUX EMPILABLES
STACKABLE SERVING TRAYS



PLATEAUX ✱ **238953**
RECTANGULAIRES 📏 **238963**
AVEC ANSES EXT : 77 X 55 CM - 30 IN^{5/16} X 21 IN^{5/8}
RECTANGULAR INT : 68,5 X 46,5 CM - 26 IN^{15/16} X 18 IN^{5/16}
SERVING TRAYS

WITH HANDLES

✱ **238954**
📏 **238964**
GASTRONORM 2/1
EXT : 65 X 53 CM - 25 IN^{9/16} X 20 IN^{7/8}
INT : 56,5 X 44,5 CM - 22 IN^{1/4} X 17 IN^{1/2}

✱ **238955**
📏 **238965**
EXT : 60 X 40 CM - 23 IN^{5/8} X 15 IN^{3/4}
INT : 51,5 X 31,5 CM - 20 IN^{1/4} X 12 IN^{3/8}



PLATEAU ROND ✱ **185024**
ROUND TRAY 📏 **186457**
EXT : 42 CM - 16 IN^{9/16}
INT : 35,1 CM - 13 IN^{13/16}



PLATEAUX ✱ **238962**
RECTANGULAIRES 📏 **238970**
SANS ANSES **GASTRONORM 1/1**
RECTANGULAR EXT : 53 X 32,5 CM - 20 IN^{7/8} X 12 IN^{13/16}
SERVING TRAYS INT : 46,5 X 26 CM - 18 IN^{5/16} X 10 IN^{1/4}
WITHOUT HANDLES

✱ **238961**
📏 **238971**
EXT : 40 X 27 CM - 15 IN^{3/4} X 10 IN^{5/8}
INT : 33,5 X 20,5 CM - 13 IN^{3/16} X 8 IN^{1/16}

✱ **238960**
📏 **238972**
GASTRONORM 1/2
EXT : 32,5 X 26,5 CM - 12 IN^{13/16} X 10 IN^{7/16}
INT : 26 X 20 CM - 10 IN^{1/4} X 7 IN^{7/8}

✱ **227767**
📏 **227768**
EXT : 22 X 14 CM - 8 IN^{11/16} X 5 IN^{1/2}
INT : 20 X 12 CM - 7 IN^{7/8} X 4 IN^{3/4}

NORMANDY



PLATEAU ✱ **232972**
RECTANGULAIRE INT : 26 X 18 CM - 10 IN^{1/4} X 7 IN^{1/16}
SANS ANSES EXT : 23 X 15 CM - 9 IN^{1/16} X 5 IN^{7/8}
RECTANGULAR
SERVING TRAY
WITHOUT HANDLES

NEWPORT PLATEAUX

Finedining



DEGRENNE
PARIS



PLATEAUX EMPILABLES
STACKABLE SERVING TRAYS

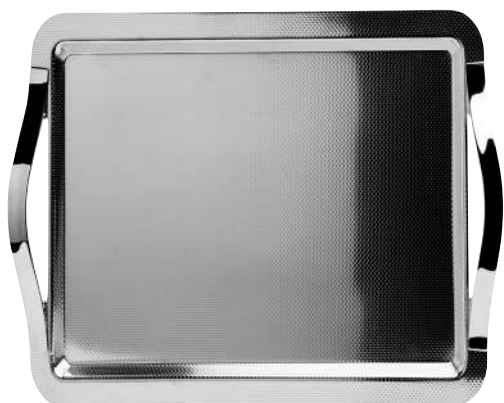

PLATEAUX ✱ **238987**
RECTANGULAIRES 📏 **238989**
AVEC ANSES **GASTRONORM 2/1**
RECTANGULAR EXT : 65 X 53 CM - 25 IN^{9/16} X 20 IN^{7/8}
SERVING TRAYS INT : 56,5 X 44,5 CM - 22 IN^{1/4} X 17 IN^{1/2}
WITH HANDLES

✱ **238988**
📏 **238990**
EXT : 60 X 40 CM - 23 IN^{5/8} X 15 IN^{3/4}
INT : 51,5 X 31,5 CM - 20 IN^{1/4} X 12 IN^{3/8}



PLATEAUX ✱ **211888**
RECTANGULAIRES 📏 **213859**
SANS ANSES **GASTRONORM 1/2**
RECTANGULAR EXT : 32,5 X 26,5 CM - 12 IN^{13/16} X 10 IN^{7/16}
SERVING TRAYS INT : 26 X 20 CM - 10 IN^{1/4} X 7 IN^{7/8}
WITHOUT HANDLES

✱ **211889**
📏 **213860**
EXT : 22 X 14 CM - 8 IN^{11/16} X 5 IN^{1/2}
INT : 20 X 12 CM - 7 IN^{7/8} X 4 IN^{3/4}



DESSOUS DE ✱ **230872**
BOUEILLE 📏 **230874**
BOTTLE 13,5 CM - 5 IN^{5/16}
COASTER

NEWPORT CUBIQUE PLATEAUX

Finedining

MADE IN FRANCE



PLATS OVALES
OVAL DISHES

■ 238958

■ 238968

EXT : 46 X 31 CM - 18 IN^{1/8} X 12 IN^{3/16}
INT : 25,9 X 13,9 CM - 10 IN^{3/16} X 5 IN^{1/2}

■ 238957

■ 238967

EXT : 41 X 28 CM - 16 IN^{1/8} X 11 IN
INT : 28,7 X 15,6 CM - 11 IN^{5/16} X 6 IN^{1/8}

■ 238956

■ 238966

EXT : 38 X 25 CM - 14 IN^{15/16} X 9 IN^{13/16}
INT : 26,6 X 16,3 CM - 10 IN^{1/2} X 6 IN^{7/16}



PLAT À POISSON
FISH DISH

■ 238959

■ 238969

INT : 60 X 27 CM - 23 IN^{5/8} X 10 IN^{5/8}
EXT : 46,3 X 14,3 CM - 18 IN^{1/4} X 5 IN^{5/8}



SAUCIÈRE
SAUCE BOAT

■ 186198

■ 186456

19 X 7,6 CM - 20 CL
7 IN^{1/2} X 3 IN - 6 OZ^{3/4}



BEURRIER
BUTTER DISH

■ 185307

■ 186455

Ø 9 X 7,6 CM - 3 IN X 2 IN^{3/4}



PORTE SUCRE
CENTRE DE TABLE
SUGAR HOLDER/TABLE

■ 211397

Ø 6,4 X H 6 CM - Ø 2 IN^{1/2} X H 2 IN^{3/8}



SOCLE BEURRIER
PORCELAINE
BUTTER DISH
BASE PORCELAIN

190255

Ø 9 X 7,6 CM - 3 IN X 2 IN^{3/4}

NEWPORT TABLE

Finedining



MADE IN FRANCE





VERSEUSES
COFFEE/TEA POTS

★ **213850**
☞ **219563**
1,5 L - 18,1 CM X H 22,4 CM
50 OZ^{3/4} - 7 IN^{1/8} X H 8 IN^{3/16}

★ **213851**
☞ **219564**
70 CL - 14,8 CM X H 14,6 CM
23 OZ^{11/16} - 5 IN^{13/16} X H 5 IN^{3/4}

★ **213852**
☞ **219565**
35 CL - 12,9 CM X H 9,3 CM
11 OZ^{13/16} - 5 IN^{1/16} X H 3 IN^{11/16}



PICHET
JUG

★ **213849**
☞ **219561**
2 L - 18,1 CM X H 23 CM
67 OZ^{5/8} - 7 IN^{1/8} X H 9 IN^{1/16}



POTS ISOTHERMES
INSULATED POTS

★ **213846**
☞ **219557**
1,2 L - 18,1 CM X H 22,7 CM
40 OZ^{9/16} - 7 IN^{1/8} X H 8 IN^{15/16}

★ **213847**
☞ **219558**
70 CL - 15,6 CM X H 19,2 CM
23 OZ^{11/16} - 6 IN^{1/8} X H 7 IN^{9/16}

★ **213848**
☞ **219559**
30 CL - 13,4 CM X H 12,7 CM
40 OZ - 5 IN^{1/4} X H 5 IN



CRÉMIERS
CREAM JUGS

★ **213853**
☞ **219566**
35 CL - 12,9 CM X H 9 CM
11 OZ^{13/16} - 5 IN^{1/16} X H 3 IN^{9/16}

★ **213854**
☞ **219567**
15 CL - 9 CM X H 9 CM
5 OZ^{1/16} - 3 IN^{9/16} X H 3 IN^{9/16}



SUCRIER
SUGAR BOWL

★ **182341**
☞ **184612**
35 CL
11 OZ^{13/16}



NEWPORT
P. 182



NEWPORT CAFÈTERIE

Finedining





SEAU À CHAMPAGNE ✪ 184180
2 BOUTEILLES ✪ 188895
 CHAMPAGNE BUCKET Ø 24 X H 25,5 CM
 2 BOTTLES Ø 9 IN^{7/16} X H 10 IN^{1/16}



SEAU À GLACE ✪ 184181
AVEC COUVERCLE ✪ 188896
 ICE BUCKET Ø 15 X H 16 CM
 WITH LID Ø 5 IN^{7/8} X H 6 IN^{5/16}

SEAU À CHAMPAGNE ✪ 186030
1 BOUTEILLE ✪ 188894
 CHAMPAGNE BUCKET Ø 20 X H 22,5 CM
 1 BOTTLE Ø 7 IN^{7/8} X H 8 IN^{27/8}



RAFRAICHISSEUR ✪ 237501
DROIT DOUBLE PAROI Ø 13,9 X H 19,8 CM
 CURVED DOUBLE Ø 5 IN^{1/2} X H 7 IN^{13/16}
 WALL WINE COOLER

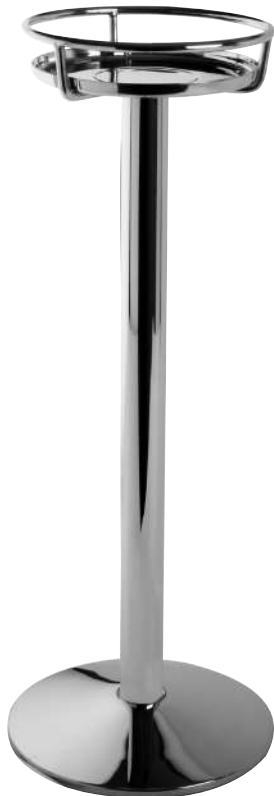

PORTE SEAU ✪ 185607
À CHAMPAGNE ✪ 188893
(1 OU 2 BOUTEILLES) H 63,5 CM - 25 IN
 CHAMPAGNE
 BUCKET STAND
 (1 OR 2 BOTTLES)



DESSOUS DE BOUTEILLE ✪ 234320
 BOTTLE COASTER 9,5 CM - 3 IN^{3/4}
 NEWPORT LOUNGE



PINCE À GLACE ✪ 004014
 ICE TONG 16 CM
 6 IN^{5/16}



NEWPORT BAR

Alldaydining





CLOCHE ASSIETTE
DOME COVER
INOX STAINLESS STEEL
* 182614
184477
Ø 24 CM - 9 IN^{7/16}

* 182301
184476
Ø 14,8 CM - 5 IN^{13/16}



CLOCHE
INOX STAINLESS STEEL
* 044113
101512
Ø 26 CM - 10 IN^{1/4}

* 044112
101510
22 CM - 8 IN^{7/8}



CLOCHE EVENTO VERRE
DOME COVER
239771
Ø 28 CM - 11 IN
239770
Ø 23 CM - 9 IN^{1/6}

239769
Ø 16 CM - 6 IN^{5/16}



VERRE BOROSILICATE
GLASS
204043
17 X 9 CM - 6 IN^{11/16} X 3 IN^{9/16}

206504
BOUCHON PORCELAINE
PORCELAIN LID
5,2 CM - 2 IN^{1/16}



CORBEILLE RONDE À PAIN
BREAD BASKET
ROUND
* 128910
131114
Ø 17,5 X H 6 CM
Ø 6 IN^{7/8} X H 2 IN^{3/8}

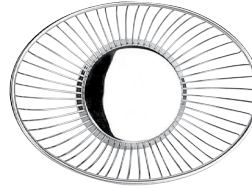

CORBEILLE OVALE À PAIN
BREAD BASKET
OVAL
* 128912
131117
Ø 24 X 17 CM - H 7,5 CM
Ø 9 IN^{7/16} X 6 IN^{11/16} - H 2 IN^{15/16}

* 128911
131118
Ø 20 X 15 CM - H 6 CM
Ø 7 IN^{7/8} X 5 IN^{7/8} - H 2 IN^{3/8}



VERRINE SEL/POIVRE AIMANTÉE
SALT & PEPPER CELLAR W/MAGNET
216920
POIVRE/PEPPER
216919
SEL/SALT
4,1 X 6,7 CM
1 IN^{5/8} X 2 IN^{5/8}

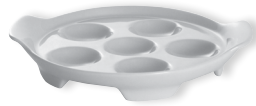

PLAT À ESCARGOTS PORCELAINE
SNAIL TONG
164138
Ø 16,6 CM - 6 IN^{9/16}



ENSEMBLE SEL/POIVRE AIMANTÉE
SALT & PEPPER CELLAR W/MAGNET
216922
8,5 X 10,6 CM
3 IN^{3/8} X 4 IN^{3/16}



PINCE À ESCARGOTS
SNAIL TONG
* 004013
16 CM - 6 IN^{5/16}



CISEAUX À GÂTEAUX
PASTRY SCISSORS/TONG
* 204496
101494
20 CM - 7 IN^{7/8}



PINCE À PAIN BREAD TONG
* 204498
101492
23 CM - 9 IN^{1/16}



PINCE À CRUSTACÉS SEAFOOD/CRAKER
* 184492
16,5 CM - 6 IN^{1/2}



PINCE À SERVIR SERVING TONG
* 204499
184355
29,5 CM - 11 IN^{5/8}



NEWPORT ACCESSOIRES

Alldaydining

MADE IN EUROPE





LE BUFFET EVENTO

EVENTO BUFFET

Du petit-déjeuner au dîner, des buffets sucrés aux buffets salés, la collection EVENTO répond à tous les scénarios de réception tout en assurant une hygiène parfaite pour satisfaire au mieux les nouvelles exigences de vos clients.

Le buffet EVENTO au design homogène, harmonieux, fonctionnel et modulable, dispose de nombreux produits qui évitent d'exposer le contenu à l'air libre tout en conservant les aliments au frais comme au chaud et qui peuvent être utilisés pour la majorité en portion individuelle ou à usage unique. La richesse de ses combinaisons et la diversité de ses matériaux (acier, porcelaine, verre, grès, mélamine pierre et bois etc...) s'adaptent à votre style et à la dimension de votre établissement. La collection EVENTO valorise avec une touche de chic la mise en scène de vos buffets, selon le moment de la journée, de la saison...

From breakfast to dinner, from sweet buffets to savoury spreads, the EVENTO collection works for all your reception needs while ensuring perfect hygiene to best meet the new requirements of your customers.

The EVENTO buffet with a unified, harmonious, practical and modular design has many products that will avoid exposing their contents to the open air while keeping the food cool as well as warm and which can be used for the most part in individual portions or single use. With a host of combinations and a range of materials to choose from (steel, porcelain, glass, stoneware, melamine, stone and wood...), you can find what works for your style and the size of your space. The EVENTO collection adds a chic touch to your buffet presentations to reflect the time of day or the season.

CHAFING DISHES*

Couvercle en verre transparent pour percevoir le contenu et rendre le buffet plus gourmand
Clear glass cover allows contents to be viewed instantly and makes the buffet more enticing

Charnière avec vérin et amortisseur pour un réel confort d'utilisation et une fermeture en douceur
The hydraulic buffering hinge offers user comfort and convenience with its soft closure mechanism

Encoches pour les couverts de service
The notch for the serving cutlery



Acier inoxydable, couvercle avec gouttière, verre trempé, système de récupération d'eau de condensation
Stainless steel, lid with groove, condensation water collection system in the porcelain insert

Compatible plaque induction, avec résistance électrique ou porte-brûleur avec gel combustible
Compatible with induction, electrical and/or «sterno» fuel heating system



2 FINITIONS
FINISHES



Ø 35,5 CM X P 41 CM X H 15 CM
Ø 14 IN X D 16 IN^{1/8} X H 5 IN^{7/8}

*Certaines pièces sont disponibles en pièces détachées
Some items are available individually

CHAFING DISHES



Le Chafing dish, par son design contemporain alliant acier, porcelaine et verre offre à votre buffet une présentation soignée et raffinée.
The Chafing dish, with its contemporary design that combines steel, porcelain and glass, brings a smart and sophisticated touch to your buffet display.

FINITION MIROIR
MIRROR FINISH



FINITION BROSSÉE
BRUSHED FINISH



CHAFING DISH 236195
SANS BAC Ø 35,5 CM - P 41 CM - H 15 CM
ACIER INOXYDABLE Ø 14 IN - D 16 IN^{7/8} - H 5 IN^{7/8}
+ COUVERCLE
AVEC GOUTIÈRE
VERRE TREMPÉ
CHAFING DISH
WITHOUT INSERT
STAINLESS STEEL
+ LID WITH GROOVE,
TEMPERED GLASS

236194
Ø 35,5 CM - P 41 CM - H 15 CM
Ø 14 IN - D 16 IN^{7/8} - H 5 IN^{7/8}

COUVERCLE 203470
AVEC GOUTIÈRE ACIER,
VERRE TREMPÉ Ø 33 CM - 13 IN
LID WITH STAINLESS STEEL
GUTTER,
TEMPERED GLASS

ACIER
STAINLESS STEEL



BAC POUR 216142
CHAFING DISH Ø 35,6 X H 7 CM
CHAFING INSERT CONTENANCE 3L
Ø 14 X 2 IN^{3/4}
CAPACITY 100 OZ

PORCELAINE
PORCELAIN



215721
Ø 35,6 X H 7 CM
CONTENANCE 3L
Ø 14 X 2 IN^{3/4}
CAPACITY 100 OZ



1/2 BAC PORCELAINE 202635
POUR L 29 X L 15 X H 4,5 CM
CHAFING DISH CONTENANCE 1L
1/2 CHAFING 11 IN^{7/16} X 5 IN^{7/8} X 1 IN^{3/4}
PORCELAIN INSERT CAPACITY 33 OZ^{13/16}



SUPPORT CHAFING 203005
ACIER INOXYDABLE Ø 35 CM - P 40 CM - H 12,5 CM
POUR RÉSTANCE Ø 13 IN^{3/4} - D 15 IN^{3/4} - H 4 IN^{15/16}
ÉLECTRIQUE
OU PORTE-BRÛLEUR
AVEC GEL COMBUSTIBLE
CHAFING STAND
STAINLESS STEEL,
FOR ELECTRICAL AND/OR
STERNO HEATING
PURPOSES



202859
Ø 35 CM - P 40 CM - H 12,5 CM
Ø 13 IN^{3/4} - D 15 IN^{3/4} - H 4 IN^{15/16}



RÉSISTANCE 202860
AVEC RÉGULATEUR 220 /240 V /200 W
DE TEMPÉRATURE 20 X 20 CM - 7 IN^{7/8} X 7 IN^{7/8}
HEATING ELEMENT
HEAT ADJUSTABLE **246341**
500 W
20 X 20 CM - 7 IN^{7/8} X 7 IN^{7/8}



PORTE-BRÛLEUR 243950
POUR GEL Ø 9 CM - H 6 CM
COMBUSTIBLE ACIER Ø 3 IN^{9/16} X 2 IN^{3/8}
BURNER HOLDER STEEL

*Certaines pièces sont disponibles en pièces détachées
Some items are available individually

*À commander obligatoirement avec le bac pour chafing dish (216142 ou 215721)
Must be ordered with the chafing insert (216142 or 215721)



REFRIGERATED UNITS*



L 56,5 CM X P 36 CM X H 9,5 CM
22 IN^{1/4} X D 14 IN^{3/16} X 3 IN^{3/4}

FINITION MIROIR
MIRROR FINISH

FINITION BROSSÉE
BRUSHED FINISH

FINITION NOIR MÉTALLISÉ
METALLIC BLACK FINISH



MODULE ACIER 202864
+ BAC PLASTIQUE⁽¹⁾ GN1/1
REFRIGERATED SET L 56,5 CM - P 36 CM - H 9,5 CM
+ PLASTIC TRAY 22 IN^{1/4} - D 14 IN^{3/16} X 3 IN^{3/4}

202865
GN1/1
L 56,5 CM - P 36 CM - H 9,5 CM
22 IN^{1/4} - D 14 IN^{3/16} X 3 IN^{3/4}

202869
GN1/1
L 56,5 CM - P 36 CM - H 9,5 CM
22 IN^{1/4} - D 14 IN^{3/16} X 3 IN^{3/4}

235356
GN1/2
29,5 X 35,6 CM
11 IN^{5/8} X 14 IN

235361
GN1/2
29,5 X 35,6 CM
11 IN^{5/8} X 14 IN

235362
GN1/2
29,5 X 35,6 CM
11 IN^{5/8} X 14 IN



COUVERCLE 202871
MODULE RÉFRIGÉRÉ 56 X 35 X 19 CM
POIGNÉE INOXYDABLE 22 IN^{1/16} X 13 IN^{3/4} X 7 IN^{1/2}
LID FOR REFRIGERATED SET/
STAINLESS STEEL HANDLE

PLAQUE EUTECTIQUE 208357
NOIRE POUR GN1/1
MODULE FROID 48 X 28 X 3 CM
BLACK COOLING 18 IN^{7/8} X 11 IN X 1 IN^{3/16}
EUTECTIC BLOCK
FOR UNIT

239786
GN1/2
18 X 25 CM
7 IN^{18/16} X 9 IN^{13/16}

3 FINITIONS
FINISHES

Le module réfrigéré reçoit une large gamme de contenants, plateaux et accessoires multi-matériaux au format GN en porcelaine, verre, acier, acrylique, mélamine pierre et mélamine bois. Ils permettent une infinité de combinaisons.

The refrigerated unit will hold a wide range of platters and multi-material accessories in Industry standard format in porcelain, glass, steel, acrylic stone and wood melamine allowing endless combinations.

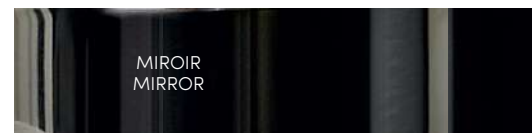

MIROIR
MIRROR



BROSSÉ
BRUSHED



NOIR MÉTALLISÉ
METALLIC BLACK

*Certaines pièces sont disponibles en pièces détachées
Some items are available individually

(1) Garantie lave-vaisselle
Dish washer safe

MODULES FROIDS



PLATEAUX POUR MODULES FROIDS
PLATTERS FOR REFRIGERATED UNITS

MÉLAMINE BOIS⁽¹⁾
WOOD MELAMINE TRAY



PLATEAUX 234546
TRAYS **GN1/1**
53 X 32,5 CM
20 IN^{7/8} X 12 IN^{13/16}



234548
GN 2/3
35,5 X 32,5 CM
14 IN X 12 IN^{13/16}



234551
GN 1/2
26,4 X 32,5 CM
10 IN^{3/8} X 12 IN^{13/16}



234553
GN 1/3
17,5 X 32,5 CM
6 IN^{7/8} X 12 IN^{13/16}



234557
GN 1/6
8,7 X 32,5 CM
3 IN^{7/16} X 12 IN^{13/16}

MÉLAMINE PIERRE⁽¹⁾
STONE MELAMINE TRAY



234547
GN1/1
53,5 X 32,5 CM
20 IN^{7/8} X 12 IN^{13/16}



234549
GN 2/3
35,4 X 32,5 CM
13 IN^{15/16} X 12 IN^{13/16}



234552
GN 1/2
26,4 X 32,5 CM
10 IN^{3/8} X 12 IN^{13/16}



234554
GN 1/3
17,5 X 32,5 CM
6 IN^{7/8} X 12 IN^{13/16}



234558
GN 1/6
8,7 X 32,5 CM
3 IN^{7/16} X 12 IN^{13/16}

ACIER 18/10 NEWPORT
FINITION MIROIR
SERVING TRAY STAINLESS STEEL
18/10 MIRROR FINISHED

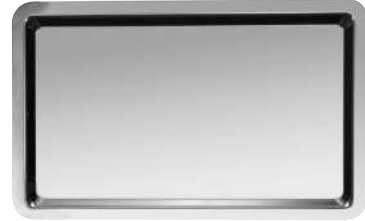

238962
GN1/1
53,5 X 32,5 CM
20 IN^{7/8} X 12 IN^{13/16}



238960
GN 1/2
26,4 X 32,5 CM
10 IN^{3/8} X 12 IN^{13/16}

(1) Compatible lave-vaisselle, NON compatible micro-ondes
Dish washer safe, DONT USE with micro-wave

VERRE ÉPAISSEUR 0,6 CM
TEMPERED GLASS THICKNESS 1/4"

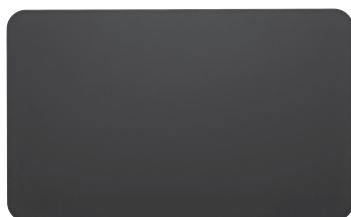

230752
GN 1/1
53,5 X 32,5 CM
20 IN^{7/8} X 12 IN^{13/16}



230753
GN 2/3
35,4 X 32,5 CM
13 IN^{15/16} X 12 IN^{13/16}

ACRYLIQUE ÉPAISSEUR 1 CM
ACRYLIC THICKNESS 3/8"

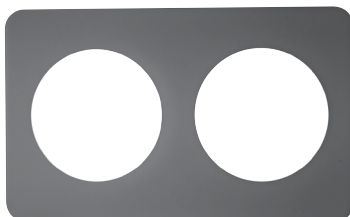

230756
GN 1/1 - 2 TROUS
2 HOLES
53,5 X 32,5 CM - 20 IN^{7/8} X 12 IN^{13/16}



230757
GN 1/3 - 2 TROUS - BOLS 14 CM
2 HOLES - BOWLS 5,5 IN
17,5 X 32,5 CM - 6 IN^{7/8} X 12 IN^{13/16}



COMPATIBLES AVEC BOLS 136529

AVAILABLE WITH BOWLS 24 CM - 9 IN^{7/16}
CONTENANCE : 2 L
CAPACITY : 67 OZ^{5/8}
H : 11 CM - 4 IN^{1/4}

136511
20 CM - 7 IN^{7/8}
CONTENANCE : 1,30 L
CAPACITY : 43 OZ^{15/16}
H : 9,5 CM - 3 IN^{3/4}

GRÈS ONYX (2)
ONYX STONEWARE



245097 NEW
GN 2/3
35,4 X 32,5 CM
13 IN^{15/16} X 12 IN^{13/16}



245098 NEW
GN 1/3
17,5 X 32,5 CM
6 IN^{7/8} X 12 IN^{13/16}



245099 NEW
GN 1/3
17,5 X 32,5 CM
6 IN^{7/8} X 12 IN^{13/16}
PLAT CREUX
STONEWARE
DEEP DISH

PORCELAINE (2)
WHITE ENAMELLED PORCELAIN



202628
GN 2/3
35,4 X 32,5 CM
13 IN^{15/16} X 12 IN^{13/16}



202629
GN 1/2
26,4 X 32,5 CM
10 IN^{3/8} X 12 IN^{13/16}



202627
GN 1/3
17,5 X 32,5 CM
6 IN^{7/8} X 12 IN^{13/16}



202630
GN 1/3
17,5 X 32,5 CM
6 IN^{7/8} X 12 IN^{13/16}
PLAT CREUX
PORCELAINE
DEEP DISH

(2) Garantie lave-vaisselle, Garantie micro-ondes
Dish washer safe, Microwave safe

URNES À JUS DE FRUITS*
FRUIT JUICE URNS

Urne à jus de fruit dotée d'un tube central en acier pour glace pilée : parfait maintien de la fraîcheur
Fruit juice urn with central steel tube to hold crushed ice, for perfect freshness



FINITION MIROIR
MIRROR FINISH

FINITION BROSSÉE
BRUSHED FINISH

URNE À JUS DE FRUITS 4L ACIER 18-10
231303
L 20 CM X P 32 CM X H 45 CM
W 7 IN^{7/8} X D 12 IN^{5/8} X H 17 IN^{11/16}

231304
L 20 CM X P 32 CM X H 45 CM
W 7 IN^{7/8} X D 12 IN^{5/8} X H 17 IN^{11/16}

JUICE DISPENSER 135 OZ
STAINLESS STEEL

CRISTALLIN SOUFLÉ BOUCHE
HAND BLOWN CRYSTALLINE



CARAFE À JUS 202639
DE FRUIT - 1,2 L Ø 10,5 CM - H 27,5 CM
JUICE/BEVERAGE Ø 4 IN^{1/8} X H 10 IN^{13/16}
CARAFE - 40 OZ^{9/16}

PORCELAINE
PORCELAIN



CARAFE 202636
À LAIT - 1,2 L Ø 10,5 CM - H 27,5 CM
MILK JUG Ø 4 IN^{1/8} X H 10 IN^{13/16}
- 40 OZ^{9/16}

Bouchon verseur, pour une meilleure hygiène
Hygienic pouring stopper



BOUCHON DE 202855
CARAFE SILICONE Ø 6,5 CM - H 4,2 CM
STOPPER FOR Ø 2 IN^{9/16} X H 1 IN^{5/8}
CARAFE SILICONE

*Certaines pièces sont disponibles en pièces détachées
Some items are available individually

DISTRIBUTEURS À CÉRÉALES*
CEREAL DISPENSERS

Distributeur à céréales 1 ou 3 tubes avec ailettes souples pour ne pas casser les céréales
Cereal dispenser 1 or 3 tubs with flexible spout so as not to break the cereals



X3

DISTRIBUTEUR À CÉRÉALES 231300

CEREAL DISPENSER L 50 CM X P 20 CM X H 55,5 CM
W 19 IN^{11/16} X D 7 IN^{7/8} X H 21 IN^{7/8}
CAPACITÉ : 3 X 3,5 L
CAPACITY : 3 X 1 GAL



X1

231299

L 19 CM X P 20 CM X H 55,5 CM
W 7 IN^{1/2} X D 7 IN^{7/8} X H 21 IN^{7/8}
CAPACITÉ : 3,5 L
CAPACITY : 1 GAL



RAFRAICHISSEUR 237501

DOUBLE PAROI Ø 13,9 X H 19,8 CM
CURVED Ø 5 IN^{7/8} X H 7 IN^{13/16}
DOUBLE WALL
WINE COOLER



BOL 154245

PORCELAINE MODULO BLANC
PORCELAIN BOWL WHITE MODULO
14 CM - 5 IN^{1/2}

202626
EMPILABLE
STACKABLE



ETIQUETTE PORCELAINE 202632
AVEC AIMANT 10 X 5 CM

+ SUPPORT ACIER 3 IN^{5/16} X 1 IN^{15/16}
PORCELAIN STICK +
STAINLESS STEEL STAND
WITH MAGNET

TRAYS

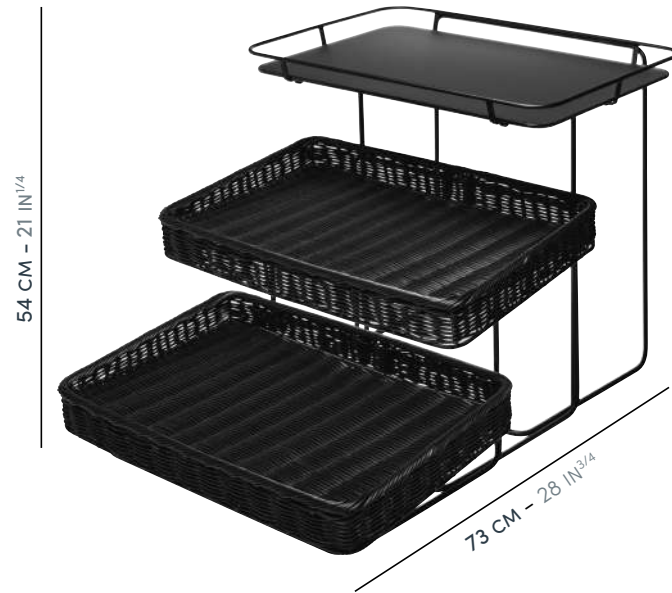

Panière reversible pour une présentation droite ou inclinée
Reversible basket for a level or titled display

SUPPORTS À FIL



Des supports en acier noir mat de hauteurs différentes pour rythmer les présentations.
Black mat finish supports of differing heights can be used to create a varied presentation.

SUPPORTS À FIL RECTANGULAIRES
RECTANGULAR TRAYS



1

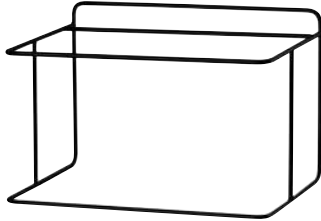

2

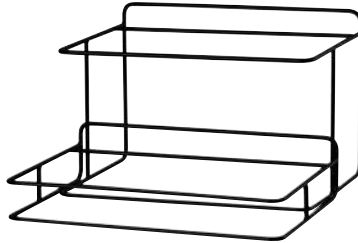

1 + 2



PANIÈRE 230749
RECTANGULAIRE GN 1/1
RECTANGULAR 54 X 34 X H 7 CM
BREAD BASKET 21 IN^{1/4} X 13 IN^{3/8} X 2 IN^{3/4}

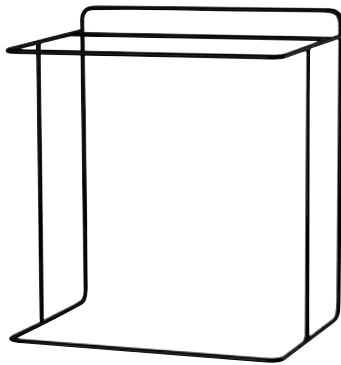

3

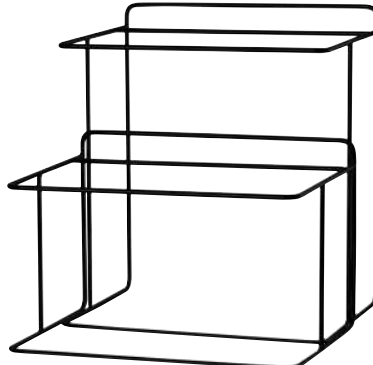

2 + 3



1 + 2 + 3

SUPPORT 230741
RECTANGULAIRE NIVEAU 1
RECTANGULAR TRAY LEVEL 1
L 44 X P 30,8 X H 10,8 CM
W 17 IN^{5/16} X D 12 IN^{1/8} X H 4 IN^{1/4}

230742
NIVEAU 2
LEVEL 2
L 42 X P 30,8 X H 29,8 CM
W 16 IN^{5/16} X D 12 IN^{1/8} X H 11 IN^{3/4}

230743
NIVEAU 3
LEVEL 3
L 40 X P 30,8 X H 48,8 CM
W 15 IN^{3/4} X D 12 IN^{1/8} X H 19 IN^{3/16}

230741 + 230742
NIVEAU 1 + 2
LEVEL 1+2
L 44 X P 50 X H 29,8 CM
W 17 IN^{5/16} X D 19 IN^{11/16} X H 11 IN^{3/4}

230742 + 230743
NIVEAU 2 + 3
LEVEL 2+3
L 42 X P 50 X H 48,8 CM
W 16 IN^{5/16} X D 19 IN^{11/16} X H 19 IN^{3/16}

230741 + 230742 + 230743
NIVEAU 1 + 2 + 3
LEVEL 1+2+3
L 44 X P 68,2 X H 48,8 CM
W 17 IN^{5/16} X D 26 IN^{7/8} X H 19 IN^{3/16}

SUPPORTS À FIL ROUNDS
ROUND TRAYS

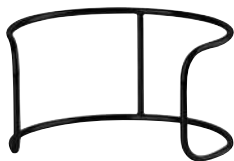

SUPPORT 230745
ROUND BAS - LOW LEVEL
ROUND STAND Ø 25 CM X H 13 CM
Ø 9 IN^{13/16} X H 5 IN^{1/8}

230746
HAUT - HIGH LEVEL
Ø 25 CM X H 26 CM
Ø 9 IN^{13/16} X H 10 IN^{1/4}

GRÈS ONYX⁽¹⁾
ONYX STONEWARE



SALADIER 245100 NEW
BAS Ø 25,4 X 7 CM - 2,4 L
SALAD BOWL Ø 10 IN X 2 IN^{3/4} - 80 OZ^{1/8}



PANIÈRES 230750
BREAD BASKETS **INDIVIDUELLE-INDIVIDUAL**
Ø 18 CM X 6 CM
Ø 7 IN^{1/16} X 2 IN^{3/8}

230748
RONDE-ROUND
Ø 32 CM X H 8 CM
Ø 12 IN^{5/8} X H 3 IN^{1/8}

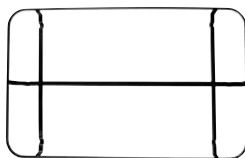

CADRE ACIER 230744
POUR SUPPORT L 55,5 X P 35 X H 4,5 CM
RECTANGULAIRE⁽¹⁾ W 21 IN^{7/8} X D 13 IN^{3/4} X H 1 IN^{3/4}
 STEEL FRAME FOR STAND



PLANCHE À PAIN 202854
BAMBOU AVEC GN 1/1
RÉCUPÉRATEUR 53 X 32,5 CM
DE MIETTES 20 IN^{7/8} X 12 IN^{13/16}
 BAMBOO BREAD BOARD
 WITH CRUMB TRAY

MÉLAMINE BOIS⁽²⁾
 WOOD MELAMINE TRAY



PLATEAUX 234546
 TRAYS **GN1/1**
 53,5 X 32,5 CM
 20 IN^{7/8} X 12 IN^{13/16}

MÉLAMINE PIERRE⁽²⁾
 STONE MELAMINE TRAY



234547
GN1/1
 53,5 X 32,5 CM
 20 IN^{7/8} X 12 IN^{13/16}

ACIER 18/10 NEWPORT
FINITION MIROIR
 SERVING TRAY STAINLESS STEEL
 18/10 MIRROR FINISHED



238962
GN1/1
 53,5 X 32,5 CM
 20 IN^{7/8} X 12 IN^{13/16}

VERRE ÉPAISSEUR 0,6 CM
 TEMPERED GLASS THICKNESS IN⁴

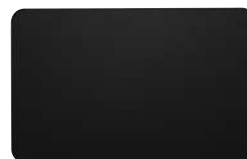

230752
GN1/1
 53,5 X 32,5 CM
 20 IN^{7/8} X 12 IN^{13/16}

MÉLAMINE BOIS⁽²⁾
 WOOD MELAMINE TRAY



PLATEAUX RONDS 234561
 ROUND TRAYS Ø 32 CM
 12 IN^{5/8}

MÉLAMINE PIERRE⁽²⁾
 STONE MELAMINE TRAY



234562
 Ø 32 CM
 12 IN^{5/8}

PORCELAINE MODULO
 MODULO PORCELAIN
 PIE/PIZZA PLATE, FLAT



136524
 Ø 32 CM
 12 IN^{5/8}

(1) Compatible lave-vaisselle, Compatible micro-ondes
 Dish washer safe, Micro-wave safe

(2) Compatible lave-vaisselle, NON compatible micro-ondes
 Dish washer safe, DONT USE with micro-wave safe



BOARDS

EPAISSEUR - 2 CM
THICKNESS - 1/2 IN

CHÈNE
OAK



PLANCHE RONDE 242942
ROUND BOARD 29,4 CM - 11 1/2 IN



**COMPATIBLE AVEC
LA CLOCHE EVENTO 239771**
COMPATIBLE WITH
EVENTO DOME COVER

NOYER
WALNUT



PLANCHE RONDE 242946
ROUND BOARD 29,4 CM - 11 1/2 IN



PLANCHE BAHIA 242941
BAHIA BOARD 35 X 21 CM - 13 3/4 X 8 1/4



PLANCHE BAHIA 242945
BAHIA BOARD 35 X 21 CM - 13 3/4 X 8 1/4



PLANCHE CARREE 242940
SQUARE BOARD 36,7 X 30 CM - 14 1/2 X 11 13/16



PLANCHE CARREE 242944
SQUARE BOARD 36,7 X 30 CM - 14 1/2 X 11 13/16



PLANCHE ALLONGEE 242939
LONG BOARD 50 X 21 CM - 19 11/16 X 8 1/4



PLANCHE ALLONGEE 242943
LONG BOARD 50 X 21 CM - 19 11/16 X 8 1/4

PLANCHES LES ESSENCES



DEGRENE
1825

ACCESSORIES



SALADIER 142722
PORCELAINE 28 CM - 11 IN
MODULO H : 12 CM - 4 IN^{3/4}
 DEEP SALAD CONTENANCE : 2,5 L
 BOWL, LARGE CAPACITY : 84 OZ^{3/16}



PRÉSENTOIR 209381
À GÂTEAUX ROND Ø 25 CM - 9 IN^{13/16}
 ROUND APP/PIZZA/
 PRESENTATION STAND **209382**
 Ø 32 CM - 12 IN^{5/6}



CLOCHE 239769
EVENTO VERRE Ø 16 CM - 6 IN^{5/16}
 EVENTO
 DOME COVER **239770**
 Ø 23 CM - 9 IN^{1/6}
239771
 Ø 28 CM - 11 IN



SUPPORT COUVERTS 202633
DE SERVICE 21 X 10 X 5 CM
PORCELAINE 8 IN^{1/4} X 3 IN^{15/16} X 1 IN^{15/16}
 SERVING
 CUTLERY DISPLAY
 WHITE PORCELAIN



ETIQUETTE 202632
PORCELAINE 10 X 5 CM
AVEC AIMANT 3 IN^{15/16} X 1 IN^{15/16}
+ SUPPORT ACIER
 PORCELAIN STICK +
 STAINLESS STEEL STAND
 WITH MAGNET

MÉLAMINE BOIS⁽²⁾
 WOOD MELAMINE TRAY



(1) PLANCHA 234559
AVEC MANCHE 17,5 X 45 CM
 BOARD 6 IN^{7/8} X 17 IN^{11/16}

MÉLAMINE PIERRE⁽²⁾
 STONE MELAMINE TRAY



234560
 17,5 X 45 CM
 6 IN^{7/8} X 17 IN^{11/16}



CISEAUX ✪ 204496
À GÂTEAUX ✪ 101494
 PASTRY
 20 CM - 7 IN^{7/8}
 SCISSORS/TONG



PINCE À SERVIR ✪ 204499
 SERVING TONG ✪ 184355
 29,5 CM - 11 IN^{5/8}



PINCE À PAIN ✪ 204498
 BREAD TONG ✪ 101492
 23 CM - 9 IN^{1/16}



LOUCHE ✪ 153193
 SOUP LADLE
ASTRÉE MIROIR
 29,7 CM - 11 IN^{11/16}

(1) Planche de présentation uniquement, ne pas faire de découpe
 Presentation board, dont cut on it

(2) Compatible lave-vaisselle, NON compatible micro-ondes
 Dish washer safe, DONT USE with micro-wave

ACCESSOIRES

PIERRE DE LUNE
MOONSTONE
Porcelaine - Porcelain



SALADIER 239325
LARGE DEEP 28 CM - 11 IN
PLATE/CUP 4L - 135 OZ^{1/4}

DUNE
BEIGE DUNE
Grès - Stoneware



235223
28 CM - 11 IN
4L - 135 OZ^{1/4}

BLEU DE ROCHE
BLUE STONE
Grès - Stoneware



235222
28 CM - 11 IN
4L - 135 OZ^{1/4}

ONYX
BLACK ONYX
Grès - Stoneware



240499
28 CM - 11 IN
4L - 135 OZ^{1/4}

ARGILE VERTE
GREEN CLAY
Grès - Stoneware



235224
28 CM - 11 IN
4L - 135 OZ^{1/4}



PLANCHE 242054
RECTANGULAIRE 35 x 21 CM
RECTANGULAR 13 IN^{3/4} x 8 IN^{1/4}
BOARD



242056
35 x 21 CM
13 IN^{3/4} x 8 IN^{1/4}



242052
35 x 21 CM
13 IN^{3/4} x 8 IN^{1/4}



237206
25 X 13,5 CM
9 IN^{13/16} X 5 IN^{5/16}



234949
25 X 13,5 CM
9 IN^{13/16} X 5 IN^{5/16}

234948
25 X 13,5 CM
9 IN^{13/16} X 5 IN^{5/16}

234950
25 X 13,5 CM
9 IN^{13/16} X 5 IN^{5/16}



PLANCHE 242055
RONDE 29 CM - 11 IN^{7/16}
ROUND
BOARD



242057
29 CM - 11 IN^{7/16}



242053
29 CM - 11 IN^{7/16}



PLAT 241835
GRAND MODÈLE 31,8 x 25 x 7,4 CM
LARGE DISH 12 IN^{1/2} x 9 IN^{13/16} x 2 IN^{15/16}

PLAT 241834
MOYEN MODÈLE 22,8 x 16,2 x 5,4 CM
MEDIUM DISH 9 IN x 6 IN^{3/8} x 2 IN^{1/8}

PLAT 241833
PETIT MODÈLE 15,5 x 10,7 x 4,4 CM
SMALL DISH 6 IN^{7/8} x 4 IN^{3/16} x 1 IN^{3/4}



237595
31,8 x 25 x 7,4 CM
12 IN^{1/2} x 9 IN^{13/16} x 2 IN^{15/16}

237594
22,8 x 16,2 x 5,4 CM
9 IN x 6 IN^{3/8} x 2 IN^{1/8}

237593
15,5 x 10,7 x 4,4 CM
6 IN^{7/8} x 4 IN^{3/16} x 1 IN^{3/4}

PLAN



44 CM - 14 IN



+ 230743

+ 230742

202854 + 230741



242055

29 CM - 11 IN^{7/16}



239325

Ø 28 CM
Ø 11 IN



240499

234562
Ø 32 CM - 12 IN^{5/8}

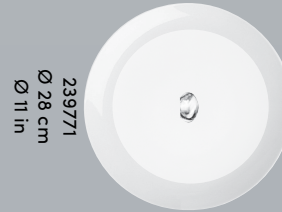

239771
Ø 28 cm
Ø 11 in

Ø 32 cm
Ø 12 IN^{5/8}

209382

35.5 CM - 14 IN

20 CM - 7 IN^{7/8}

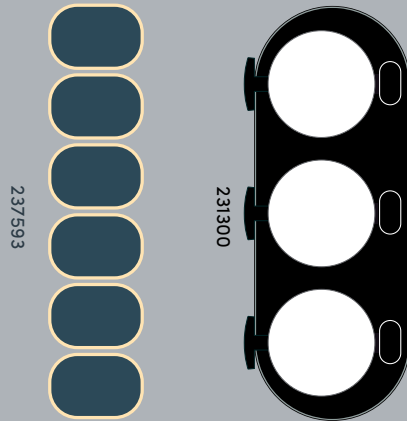

231300

237593

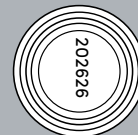

202626

32 CM - 12 IN^{5/8}

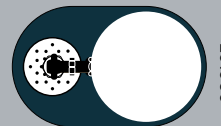

231303

20 CM
7 IN^{7/8}

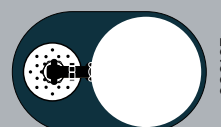

231303

20 CM
7 IN^{7/8}

50 CM - 19 IN^{11/16}

CHAFING DISH

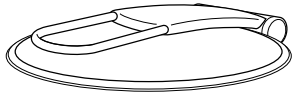

COUVERCLE AVEC GOUTTIÈRE 203470
ACIER ET VERRE TREMPÉ Ø 33 CM - Ø 13 IN
LID WITH STAINLESS STEEL
GUTTER,
TEMPERED GLASS

JOINT POUR CHAFING DISH 230050
SEAL FOR CHAFING DISH

KIT REPARATION CHARNIERES 247023
P/CHAFING DISH
CHAFING DISH
HINGE REPAIR KIT

MODULE FROID REFRIGERATED UNIT



BAC PLASTIQUE 202866
PLASTIC TRAY 56 X 35,5 X 8 CM
22 IN^{1/16} X 14 IN X 3 IN^{1/8}

235357
29,5 X 35,6 CM
11 IN^{5/8} X 14 IN

PIÈCES DÉTACHÉES

URNE À JUS DE FRUITS FRUIT JUICE URN

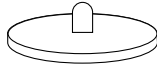

COUVERCLE URNE 202881
ACIER 18-10 **FINITION MIROIR**
LID FOR STAINLESS MIRROR FINISH
DISPENSER 18-10 Ø 17,9 CM
7 IN^{1/16}

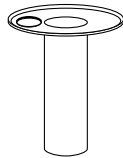

TUBE ACIER POUR 202884
GLACE Ø 9 CM - 3 IN^{9/16}
ICE TUBE
STAINLESS STEEL

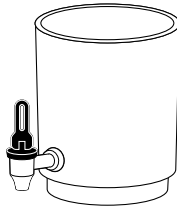

FÛT CYLINDRIQUE 202883
URNE 5 L - 169 OZ^{1/16}
CONTAINER FOR Ø 17,7 CM X H 25,5 CM
DISPENSER Ø 6 IN^{15/16} X H 10 IN^{1/16}

ROBINET ACIER 214724
ABS NOIR
STAINLESS STEEL
FAUCET BLACK

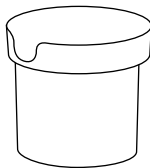

BASE ACIER 202890
18-10 URNE **FINITION MIROIR**
STAINLESS STEEL MIRROR FINISH
STAND FOR Ø 17,6 CM - H 19 CM
DISPENSER 18-10 6 IN^{15/16} X 7 IN^{1/2}

202889
FINITION BROSSÉE
BRUSHED FINISH
Ø 17,6 CM - H 19 CM
6 IN^{15/16} X 7 IN^{1/2}



GRILLE ACIER 045963
POUR GOUTTES - 18/10 Ø 9 CM
STAINLESS STEEL GRID Ø 3 IN^{9/16}
DROP COLLECTOR



SOCLE NOIR ACRYLIQUE URNE 230758
STAND FOR BLACK DISPENSER 20 X 32 CM
7 IN^{7/8} X 12 IN^{5/8}
ÉPAISSEUR : 2 CM
THICKNESS: 13/16 IN

DISTRIBUTEUR À CÉRÉALES CEREAL DISPENSER



COUVERCLE 213078
DISTRIBUTEUR CEREALES Ø 12,5 CM
ACIER FINITION MIROIR - 18/10 Ø 4 IN^{15/16}
LID FOR CEREAL DISPENSER,
STAINLESS STEEL,
MIRROR FINISH

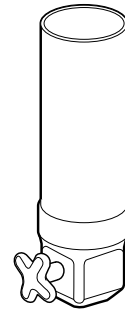

FUT CYLINDRIQUE 213076
AVEC AILETTE ET POIGNEE P 16,1 X H 42 CM
DISTRIBUTEUR CEREALES D 6 IN^{5/16} X H 16 IN^{9/16}
BARREL + HANDLE + ROLLING TAP
FOR CEREAL DISPENSER

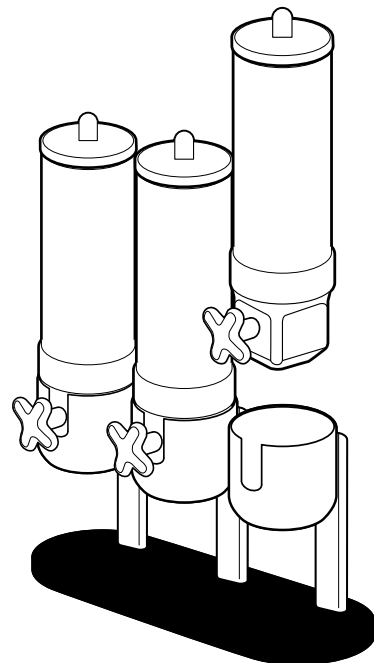

X3

X1

BASE + TUBE + SOCLE 231302
DISTRIBUTEUR À CEREALES L 50 X H 27,5 CM
STAINLESS STEEL STAND + TUB L 19 IN^{11/16} X H 29 IN^{3/4}
+ ACRYLIC STAND FOR CEREAL DISPENSER

231301
L 19 X H 27,5 CM
L 7 IN^{1/2} X H 29 IN^{3/4}

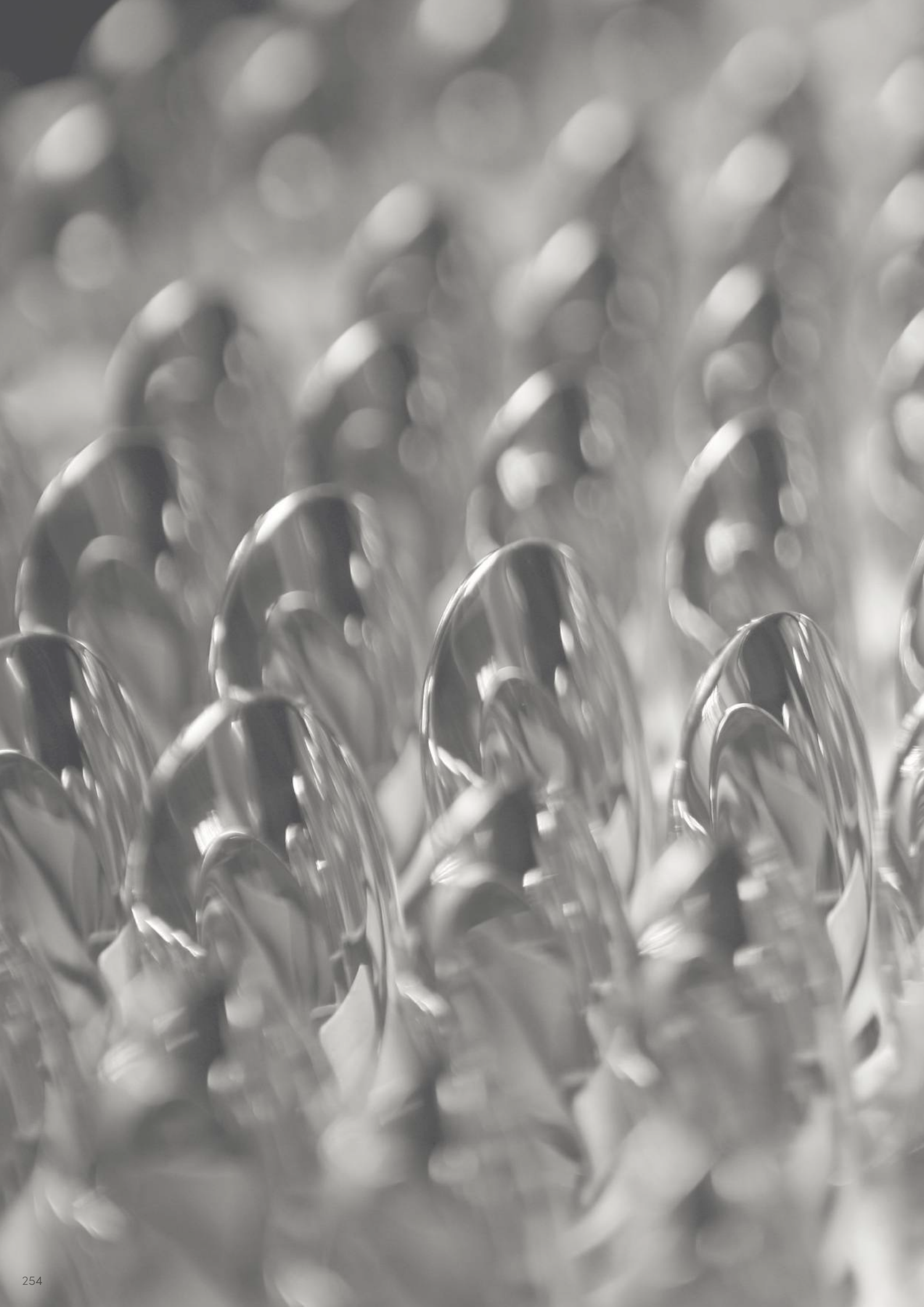

LES BASIQUES

Basics

Pensés initialement pour répondre aux besoins des collectivités, «LES BASIQUES» revisitent des gammes de couverts et platerie Made In France ainsi que de vaisselle Made in Europe. Chaque pièce évoque discrètement ce mélange entre héritage et exigences contemporaines : des formes simples, des détails subtils, et un usage fonctionnel. Le tout avec le marquage DEGRENNE, véritable gage de qualité.

En mariant judicieusement des formes issues de nos archives à une approche moderne, ces collections s'inscrivent dans une démarche éco-responsable et deviennent un choix idéal pour tout établissement à la recherche d'une touche de rétro.

Originally designed to meet the needs of communities, BASICS reimagines its ranges of Made In France cutlery and tableware, as well as those of Made in Europe dinnerware. Each piece subtly reflects the blend of heritage and contemporary requirements: simple shapes, subtle details, and functional use. All of this comes with the DEGRENNE branding, a true mark of quality.

By skillfully combining shapes from our archives with a modern approach, these collections embraces an eco-responsible approach and becomes an ideal choice for establishments seeking a touch of retro.



169511
FOURCHETTE DE TABLE
 TABLE FORK
 19,9 CM - 7 IN^{13/16}



169513
COUTEAU À STEAK
MONOBLOC LAME SCIE
 STEAK KNIFE SOLID HANDLE SERRATED
 22,3 CM - 8 IN^{3/4}



169510
CUILLÈRE DE TABLE
 TABLE/PASTA SPOON
 20,1 CM - 7 IN^{15/16}



184372
FOURCHETTE À DESSERT/POISSON
 DESSERT/SALAD/FISH FORK
 17,9 CM - 7 IN^{1/16}



184374
CUILLÈRE À DESSERT
 DESSERT/SOUP SPOON, OVAL
 18 CM - 7 IN^{1/16}



184371
COUTEAU À DESSERT
MONOBLOC LAME UNIE
 DESSERT KNIFE SOLID HANDLE
 19,8 CM - 7 IN^{13/16}



169512
CUILLÈRE À CAFÉ
 COFFEE/TEA SPOON
 13,6 CM - 5 IN^{3/8}

Bar

136123
LOT DE 12 CUILLÈRES MOKA
 BATCH OF 12 DEMI TASSE SPOONS
 10,8 CM - 4 IN^{1/4}

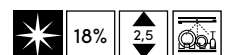

AMAZONE





193762
FOURCHETTE DE TABLE
 TABLE FORK
 20 CM - 7 IN^{7/8}



193764
COUTEAU DE TABLE
MONOBLOC LAME SCIE
 TABLE KNIFE SOLID HANDLE SERRATED
 23,2 CM - 9 IN^{5/8}



193761
CUILLÈRE DE TABLE
 TABLE/PASTA SPOON
 20,2 CM - 7 IN^{15/16}



195773
FOURCHETTE À DESSERT
 DESSERT/SALAD FORK
 17,9 CM - 7 IN



195772
CUILLÈRE À DESSERT
 DESSERT/SOUP SPOON, OVAL
 17,8 CM - 7 IN



195774
COUTEAU À DESSERT
MONOBLOC LAME UNIE
 DESSERT KNIFE SOLID HANDLE
 20,2 CM - 7 IN^{15/16}



193763
CUILLÈRE À CAFÉ
 COFFEE/TEA SPOON
 13,6 CM - 5 IN^{3/8}



198323
CUILLÈRE MOKA
 DEMI TASSE SPOON
 11 CM - 4 IN^{5/16}

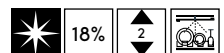

CASSIOPEE



BLANC
WHITE



ASSIETTE 216531
PLATE 12 CM - 4 IN^{3/4}
RONDE
ROUND
PLATE



ASSIETTE 216530
À SALADE 20 CM - 7 IN^{7/8}
RONDE
ROUND
SALAD
PLATE



ASSIETTE 216532
OBLONGUE 19 X 32 CM - 7 IN^{1/2} X 12 IN^{5/8}
OBLONG _____
PLATE 216533
12 X 20 CM - 4 IN^{3/4} X 7 IN^{7/8}



ASSIETTE 216536
À CREME BRULEE 13,5 CM - 5 IN^{5/16}
CREME BRULEE
ROUND PLATE



COUPELLE 216535
RONDE 14 CM - 5 IN^{1/2}
ROUND _____
DEEP 216534
PLATE 12 CM - 4 IN^{3/4}
20 CL - 7 OZ^{7/8}

GRIS
GREY



PLAT À GRATIN 198935
ROND 14 CM - 5 IN^{1/2}
ROUND
CASSEROLE
PLATE



GOBELET 198936
ROND 9 CM - 3 IN^{9/16}
ROUND CUP



ESSENTIELLE

MADE IN EUROPE 





ASSIETTE 194112
PLATE 26 CM - 10 IN^{1/4}
 DINNER PLATE



ASSIETTE 194115
DESSERT 20 CM - 7 IN^{7/8}
 ROUND
 DESSERT
 PLATE



ASSIETTE 194113
CREUSE 22 CM - 8 IN^{11/16}
 ROUND
 SOUP PLATE **194114**
 19 CM - 7 IN^{1/2}



ASSIETTE 194116
À PAIN 15 CM - 5 IN^{7/8}
 ROUND
 BREAD & BUTTER
 PLATE



PLAT ROND PLAT 194110
 ROUND DISH 30 CM - 11 IN^{13/16}



PLAT OVALE 194122
 OVAL DISH 36 CM - 14 IN^{3/16}
194123
 28 CM - 11 IN



PLAT 194121
À CAKE 40x13 CM - 15^{3/4}x5^{1/8}
 RECTANGULAR
 CAKE DISH



BOL 194120
 BOWL 13 CM - 5 IN^{1/8}



SAUCIERE 194139
 SAUCE JUG 20 CL - 6 OZ^{3/4}



CREMIER 194137
 CREAM JUG 10 CL - 3 OZ^{3/8}



MUG 247356 NEW
 MUG 30 CL - 11 OZ^{13/16}



TASSE À ESPRESSO 194125
 ESPRESSO CUP 9 CL - 3 OZ^{1/16}



TASSE À CAFÉ 194126
 DEMITASSE CUP 18 CL - 6 OZ^{1/16}



TASSE À THÉ 194127
 COFFEE/TEA CUP 26 CL - 8 OZ^{13/16}

SOUCOUE À ESPRESSO 194129
 ESPRESSO SAUCER 13 CM - 5 IN^{1/8}

SOUCOUE À CAFÉ 194130
 DEMITASSE SAUCER 14 CM - 5 IN^{1/2}

SOUCOUE À THÉ 194131
 COFFEE/TEA SAUCER 16 CM - 6 IN^{7/16}



GLORIA

MADE IN EUROPE





ASSIETTE 109343
PLATE 26,5 CM - 10 IN^{3/7}
 ROUND
 DINNER PLATE **109338**
 24 CM - 9 IN^{4/9}

109340
 19 CM - 7 IN^{1/2}



ASSIETTE 109339
CREUSE 22 CM - 8 IN^{2/3}
 ROUND
 SOUP PLATE



ASSIETTE 109344
À PAIN 16 CM - 6 IN^{2/7}
 ROUND
 BREAD & BUTTER
 PLATE



PLAT OVALE 247357 **NEW**
 OVAL DISH 38 CM - 14 IN^{5/16}



247358 **NEW**
 32 CM - 12 IN^{5/8}



247359 **NEW**
 25 CM - 8 IN^{7/16}



TASSE À MOKA 109341
 MOKA CUP 10 CL - 3 OZ^{3/8}

SOUCOUPE À MOKA 109342
 MOKA SAUCER 13 CM - 5 IN^{1/8}



TASSE À THÉ 054301
 COFFEE/TEA CUP 16 CL - 5 OZ^{7/16}

SOUCOUPE À THÉ 054302
 COFFEE/TEA SAUCER 15 CM - 5 IN^{7/8}



TASSE À DÉJEUNER 054303
 BREAKFAST CUP 28 CL - 9 OZ^{7/16}

SOUCOUPE À DÉJEUNER 054308
 BREAKFAST SAUCER 16 CM - 6 IN^{2/7}



UNISET

MADE IN EUROPE 



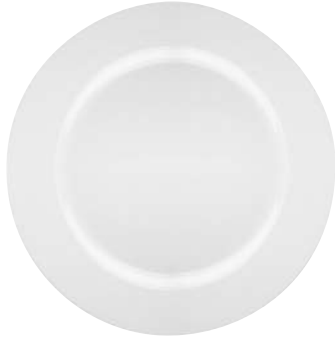

ASSIETTE 223287
PLATE 30 CM - 11 IN^{13/16}
 ROUND
223286
 DINNER PLATE 26,5 CM - 10 IN^{7/16}

223285
 20 CM - 7 IN^{7/8}



ASSIETTE 223288
CREUSE 19 CM - 7 IN^{1/2}
 ROUND
 SOUP PLATE



ASSIETTE 223294
À PIZZA 30 CM - 11 IN^{13/16}
 PIZZA PLATE



ASSIETTE 223363
À PAIN 15 CM - 5 IN^{7/8}
 ROUND
 BREAD & BUTTER
 PLATE



MUG 223293
 MUG 30 CL - 10 OZ^{1/8}



TASSE À CAFÉ 223289
 DEMITASSE CUP 11 CL - 3 OZ^{3/4}

SOUCOUBE À CAFÉ 223290
 DEMITASSE SAUCER 12 CM - 4 IN^{3/4}



TASSE À THÉ 223291
 COFFEE/TEA CUP 20 CL - 6 OZ^{3/4}

SOUCOUBE À THÉ 223292
 COFFEE/TEA SAUCER 15 CM - 5 IN^{7/8}



VITAL

MADE IN EUROPE



PLATEAUX
TRAYS



PLATEAU COMPARTIMENTÉ 240688
LUNCH TRAY 39,5 X 29,5 CM - 15 IN^{9/16} X 11 IN^{5/8}



PLATEAU COMPARTIMENTÉ 242663
MATERNELLE 33,5 X 24,6 CM - 13 IN^{3/16} X 9 IN^{11/16}
LUNCH TRAY FOR NURSERY SCHOOL

POTS À VERSER EMPILABLES
STACKABLE WATER JUGS



POT À VERSER 003968
EMPILABLE 2 L - 12 X 17 CM - 67 OZ^{5/8} - 4 IN^{3/4} X 6 IN^{11/16}
STACKABLE
WATER JUG **003967**
1,5 L - 10,5 X 16 CM - 50 OZ^{3/4} - 4 IN^{1/8} X 6 IN^{5/16}

003966
1 L - 9,5 X 13,5 CM - 33 OZ^{13/16} - 3 IN^{3/4} X 5 IN^{5/16}



POTS À VERSER UNI LOURD
WATER JUGS



POT À VERSER 004042
WATER JUG 2 L - 12,5 X 19 CM - 67 OZ^{5/8} - 4 IN^{15/16} X 7 IN^{1/2}

004041
1,5 L - 11 X 17,5 CM - 50 OZ^{3/4} - 4 IN^{5/16} X 6 IN^{7/8}

004040
1 L - 9,5 X 15 CM - 33 OZ^{13/16} - 3 IN^{3/4} X 5 IN^{7/8}

004039
0,5 L - 7 X 10 CM - 16 OZ^{15/16} - 2 IN^{3/4} X 5 IN^{15/16}

VISUELS NON CONTRACTUELS
NON CONTRACTUAL VISUALS



UNI

MADE IN FRANCE



PLATS À GRATIN
RECTANGULAR GRATIN DISHES



PLAT 003940
À GRATIN 45 X 31,5 CM - 17 IN^{11/16} X 12 IN^{3/8}
RECTANGULAIRE
RECTANGULAR **003941**
GRATIN DISH 37 X 25 CM - 14 IN^{9/16} X 9 IN^{13/16}

PLATS À ESCARGOTS
SNAIL DISHES

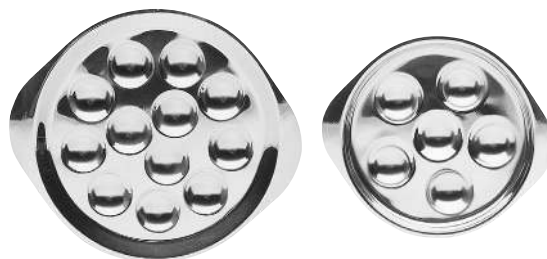

PLAT À ESCARGOTS 003935
12 PLACES 20 CM - 9 IN^{1/16}
SNAIL DISH 12 HOLES
6 PLACES 003934
SNAIL DISH 6 HOLES 14,5 CM - 6 IN^{1/2}



PLATS À GRATIN OVALES
OVAL GRATIN DISHES



PLAT 003939
À GRATIN 38 X 28 CM - 14 IN^{5/16} X 11 IN
OVALE
OVALGRATIN DISH **003937**
24 X 15 CM - 9 IN^{7/16} X 5 IN^{7/8}

CORBEILLES À PAIN
BREAD BASKETS



CORBEILLE À PAIN 003919
CANNELÉE 31 X 21 CM - 12 IN^{3/16} X 8 IN^{1/4}
FLUTED
BREAD BASKET **003918**
26 X 18 CM - 10 IN^{1/4} X 7 IN^{1/16}



SOUPIÈRES
SOUP TUREEN



SOUPIÈRE 003971
SOUP TUREEN 24 X 9,5 CM - 9 IN^{7/16} X 3 IN^{3/4}
270 CL - 91 OZ^{5/16}
003970
22 X 9,5 CM - 8 IN^{11/16} X 3 IN^{3/4}
220 CL - 74 OZ^{3/8}
003969
20 X 8,5 CM - 7 IN^{7/8} X 3 IN^{3/8}
170 CL - 57 OZ^{1/2}

18-10

18%

18%

RAMEQUIN
RAMEKIN



RAMEQUIN 003975
RAMEKIN 8 CM - 3 IN^{1/8}
19 CL - 6 OZ^{7/16}

18-10



PLATEAUX RECTANGULAIRES
RECTANGULAR SERVING TRAYS



PLATEAU 003929
RECTANGULAIRE AVEC ANSES
RECTANGULAR SERVING TRAY WITH HANDLES
45 X 31,5 CM - 17 IN^{11/16} X 12 IN^{3/8}



PLATEAU 003930
RECTANGULAIRE SANS ANSES
RECTANGULAR SERVING TRAY WITHOUT HANDLES
45 X 31,5 CM - 17 IN^{11/16} X 12 IN^{3/8}

PLATEAU ROND
ROUND SERVING TRAY



PLATEAU 044811
LIMONADIER
ROUND SERVING TRAY
40 CM - 15 IN^{3/4}



PLATS
TRAYS



PLAT 003947
OVALE
OVALE DISH
46 X 31 CM - 18 IN^{1/8} X 12 IN^{3/16}

003945
39 X 25 CM - 15 IN^{3/8} X 9 IN^{13/16}

003944
34 X 23 CM - 13 IN^{3/8} X 9 IN^{1/16}



PLAT 003948
À POISSON
FISH DISH
60 X 27 CM - 23 IN^{5/8} X 10 IN^{5/8}



PLAT 003951
ROND PLAT
ROUND FLAT DISH
33 CM - 13 IN



SEAUX
BUCKETS



SEAU À GLACE 004047
AVEC ANSE
ICE BUCKET WITH HANDLE
0,5 L - 10 CM
16 OZ^{15/16} - 3 IN^{15/16}



SEAU À GLACE 160899
SANS ANSE
ICE BUCKET WITHOUT HANDLE
1 L - 13 CM
33 OZ^{13/16} - 5 IN^{1/8}



SEAU À CHAMPAGNE 154148
SANS ANSE
CHAMPAGNE BUCKET WITHOUT HANDLE
300 CL - 19 CM
101 OZ^{7/16} - 7 IN^{1/2}





ARGENTURE CLASSE 1 - 33 MICRONS
(POUR LES ARTICLES À USAGE FRÉQUENT)
CLASS 1 SILVER PLATED - 33 MICRONS



**ARGENTURE QUALITÉ HÔTELIÈRE-
10 MICRONS**
SILVER PLATED HOTEL QUALITY- 10 MICRONS



FINITION MIROIR
MIRROR FINISH



FINITION SATINÉE
SATIN FINISH



FINITION CONTRASTE
CONTRAST FINISH



FINITION VINTAGE
VINTAGE FINISH



FORGÉ
FORGED

18%



ACIER INOXYDABLE
STAINLESS STEEL



EPAISSEUR FOURCHETTE DE TABLE
THICKNESS TABLE FORK



REVÊTEMENT PVD
PVD COATING



PORCELAINÉ
PORCELAIN



AIMANTÉ
WITH MAGNET



GRÈS
STONEWARE



EMPILABILITÉ
STACKABLE



RÉSISTE AUX CHOCS
SHOCK RESISTANT



RÉSISTE AUX TACHES
STAIN RESISTANT



VERRE
GLASS



SHQ/ SODOCALCIQUE
HAUTE QUALITÉ
HIGH QUALITY SODA - LIME



CRISTALLIN HAUTE QUALITÉ
HQ LOW LEAD CRYSTAL



VERRE SOUFFLÉ BOUCHE TEINTÉ
DANS LA MASSE
HAND-BLOWN INTEGRALLY DYED GLASS



1000 CYCLES GARANTIS MINIMUM
1000 WASH CYCLES GUARANTEED



CRISTALLIN
CRYSTALLINE



SOUFFLÉ MÉCANIQUE
MACHINE BLOWN



FINESSE DU BUVANT
THICKNESS OF THE RIM



LÉGÈRETÉ
LIGHTNESS



GARANTIE MICRO-ONDES
MICROWAVE SAFE



GARANTIE LAVE-VAISSELLE
DISHWASHER SAFE



GARANTIE CONGÉLATEUR
FREEZER SAFE



GARANTIE FOUR
OVEN SAFE



JUSQU'À ÉPUISEMENT
DES STOCKS
UNTIL STOCK LAST



FABRIQUÉ EN FRANCE
MADE IN FRANCE



FABRIQUÉ EN EUROPE
MADE IN EUROPE

FRANCE USA

SIÈGE SOCIAL/HEAD OFFICE
SERVICE CLIENTS/CUSTOMER SERVICES

rue Guy Degrenne - BP 50056
14502 Vire cedex
TEL : +33 02 31 66 44 15

OTHER COUNTRIES
TEL : +33 02 31 66 44 15

infohotel@degrenne.fr

FILIALE USA/US SUBSIDIARY

DNA/DEGRENNÉ NORTH AMERICA INC.
301 OXFORD VALLEY ROAD, SUITE 1903-B,
YARDLEY, PA 19067

TEL : +1 732 565 0820
FAX : +1 732 565 0828

csr.v.dna@degrenneparis.com
www.degrennenorthamerica.com

SHOWROOM (BY APPOINTMENT)
41 Madison Avenue, 15th Floor
NEW YORK, NY 10010

www.pro.degrenne.fr





FRANCE

infohotel@degrenne.fr
Tel : +33 02 31 66 44 15

OTHER COUNTRIES/OTROS PAISES

infohotel@degrenne.fr
Tel : +33 02 31 66 44 15

FILIALE USA/US SUBSIDIARY

csvr.dna@degrennenorthamerica.com
Tel : +1 732 565 0820

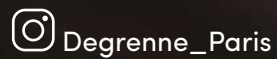

www.pro.degrenne.fr