

IL SOLE È  
NUOVO  
OGNI  
GIORNO

THE SUN IS  
NEW EVERY  
DAY

**DESIGN** COLLECTION 2022

**OV**  
ombrellificio®  
veneto by Doro



**IL SOLE È NUOVO  
OGNI GIORNO**

**THE SUN IS NEW  
EVERY DAY**

**OV**  
**ombrellificio®**  
**veneto** by Doro

**DESIGN**  
**COLLECTION**  
**2022**

# ombrellificio veneto

**DA OLTRE 30 ANNI  
LEADER NELLA PRODUZIONE  
DI OMBRELLONI**

**FOR OVER 30 YEARS  
LEADER IN PRODUCTION  
OF PARASOLS**

Ombrellificio Veneto è un'azienda che dal 1983 produce ombrelloni da giardino e da bar/ristorante, ombrelloni pubblicitari e fioriere, in alluminio e legno. La vasta gamma di prodotti, la cura nei dettagli tipica della migliore tradizione artigiana, la professionalità e la tecnologia usata nei sistemi di produzione, unite ad un design elegante e raffinato, fanno della nostra azienda una garanzia per la clientela più varia ed esigente nel settore dell'arredo per esterni.

Since 1983 Ombrellificio Veneto it's an italian firm that produces garden/bar/restaurant parasols, advertising parasols and flower boxes, in aluminium and wood. The wide range of products, the care in details typical of the best artisan tradition, the professionalism and technology used in the production systems, together with an elegant and refined design, make our firm as a reference point and a warrant for the most diverse and particular clientele in the outdoor - life style sector.

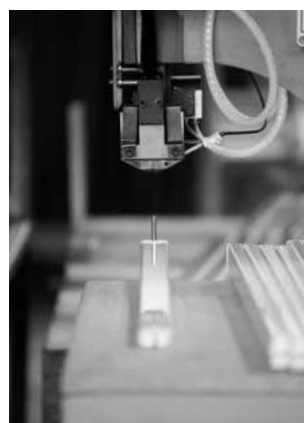

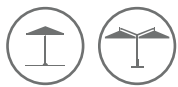





# 9

## OMBRELLONI A PALO CENTRALE GIGANTI E MULTIPLI

### GIANT CENTRAL POLE AND MULTIPLE PARASOLS

LEONARDO 10

GALILEO 14

FELLINI 18



# 23

## OMBRELLONI A BRACCIO LATERALE

### LATERAL ARM PARASOLS

SATURNO 24

VESPUCCI 28

VENERE 32

AFRODITE 36

MARTE 38

RIVIERA 42

HORIZON 46

FLAT 50

MURALES 54

ETERNITY 58

PITAGORA 62

ECLISSE 66



# 71

**OMBRELLONI  
A PALO  
CENTRALE**

**CENTRAL POLE  
PARASOLS**

# 99

**MEZZI  
OMBRELLONI**

**HALF  
PARASOLS**

DOLOMITI ALLUMINIO 72

DOLOMITI LEGNO 76

PETRARCA ALLUMINIO 80

PETRARCA LEGNO 84

OCEAN ALLUMINIO 88

OCEAN LEGNO 92

LAGUNA 94

CITY 100



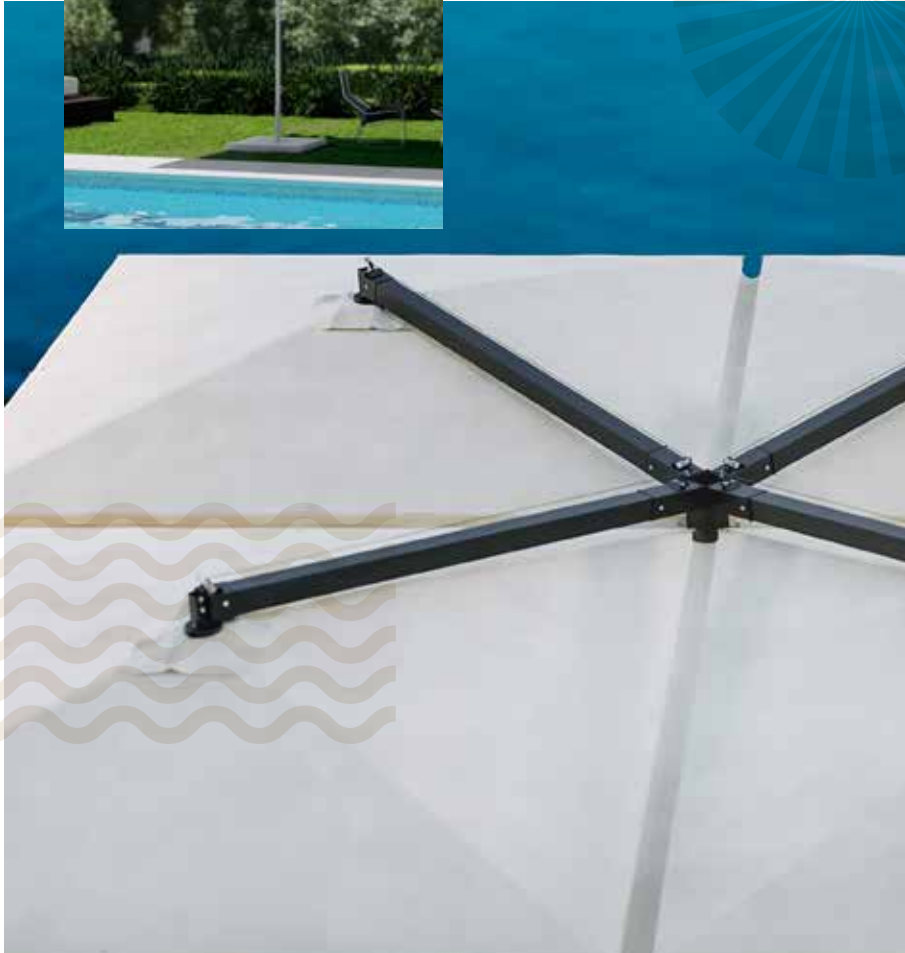

# OMBRELLONI A PALO CENTRALE GIGANTI E MULTIPLI

## GIANT CENTRAL POLE AND MULTIPLE PARASOLS



LEONARDO	10
----------	----

GALILEO	14
---------	----

FELLINI	18
---------	----







## LEONARDO

ombrellone  
a palo centrale  
in alluminio  
aluminium central  
pole parasol

- chiusura telescopica sopra i tavoli
- svariate misure, da 3x5 fino a 7x7
- base optional
- versione standard con pendente
  
- telescopic system for closing over the tables below
- several sizes since 3x5 until 7x7
- optional base
- standard version with flounce

scheda tecnica  
data sheet  
pag. 104





- versione standard con pendente
- dispositivo chiusura telescopica sopra i tavoli brevettata (escluso 6x6)
- di serie completo di 4 canaline
  
- standard version with flounce
- patented telescopic system for closing over the tables below (not 6x6)
- standard with 4 gutters

scheda tecnica  
data sheet  
pag. 106



## **GALILEO**

ombrellone multiplo  
telescopico in alluminio  
multiple telescopic  
parasol in aluminium











## FELLINI

ombrellone multiplo  
telescopico in alluminio  
multiple telescopic  
parasol in aluminium

- disponibile in versione a "V" e a "T"
- di serie completo di canalina
- versione standard con pendente
- available in "V" and "T" versions
- standard with gutter
- standard version with flounce

scheda tecnica  
data sheet  
pag. 107







# OMBRELLONI A BRACCIO LATERALE

## LATERAL ARM PARASOLS

SATURNO	24
VESPUCCI	28
VENERE	32
AFRODITE	36
MARTE	38
RIVIERA	42
HORIZON	46
FLAT	50
MURALES	54
ETERNITY	58
PITAGORA	62
ECLISSE	66



- girevole 360°
- sezione pali 9.2x9.2
- 360° rotating
- section poles 9.2x9.2

scheda tecnica  
data sheet

pag. 108

# 360°

# SATURNO

ombrellone a braccio  
laterale in alluminio  
aluminium lateral  
arm parasol







# VESPUCCI

ombrellone a braccio  
laterale in legno  
wooden lateral  
arm parasol

- girevole 360°
- sezione pali 9.2x9.2
- 360° rotating
- section poles 9.2x9.2

scheda tecnica  
data sheet  
pag. 109







## VENERE

ombrellone a braccio laterale  
in alluminio verniciato grigio  
antracite

aluminium lateral arm parasol  
anthracite varnished

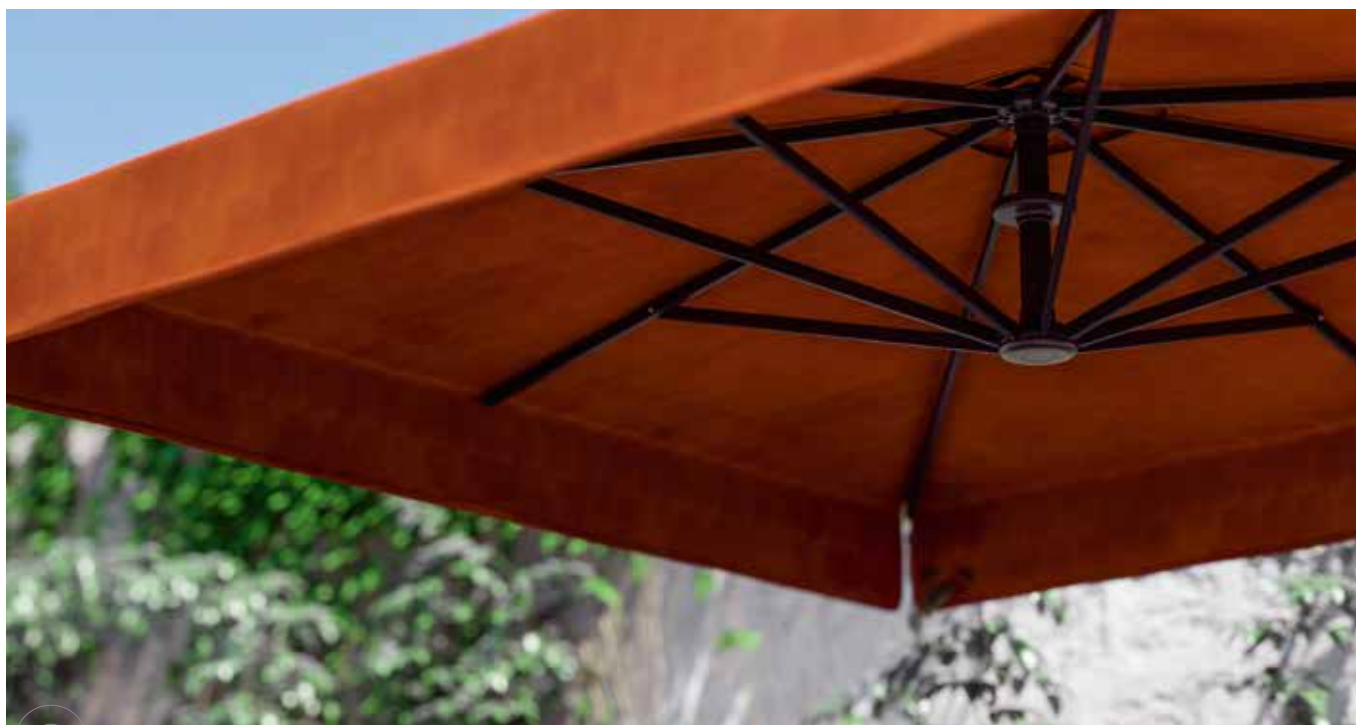

360

- girevole 360°
- sezione pali 7.2x7.2

360

- 360° rotating
- section poles
- 7.2x7.2

scheda tecnica  
data sheet  
pag. 110











## AFRODITE

ombrellone a braccio laterale  
in alluminio verniciato bianco  
aluminium lateral arm parasol  
white varnished

360°

- girevole 360°
- versione standard con pendente
- 360° rotating
- standard version with flounce

scheda tecnica  
data sheet  
pag. 111



## MARTE

ombrellone a braccio laterale in  
alluminio verniciato tortora  
aluminium lateral arm  
parasol dove grey varnished

- girevole 360°
- possibilità di  
fissaggio al suolo
- 360° rotating
- possibility of fixing  
on the ground

scheda tecnica  
data sheet  
pag. 112

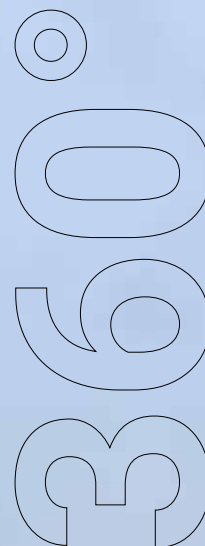





- girevole 360°
- sezione pali 7.2x7.2
- 360° rotating
- section poles 7.2x7.2

scheda tecnica  
data sheet  
pag. 113

# 360°



## RIVIERA

ombrellone a braccio laterale  
in legno  
wooden lateral arm parasol







## HORIZON

ombrellone a braccio  
laterale orientabile  
in alluminio verniciato  
grigio antracite

aluminium lateral  
orientable arm parasol  
anthracite varnished

- orientabile a dx e a sx
- girevole 360°
- orientable right and left
- 360° rotating

scheda tecnica  
data sheet

pag. 114

360







- apertura e chiusura a ventaglio
- orientabile a dx e a sx
- fan shaped opening and closing
- orientable right and left

scheda tecnica  
data sheet  
pag. 115

# 360°



## FLAT

ombrellone a braccio laterale  
a ventaglio in alluminio

fan shaped aluminium lateral arm  
parasol







## MURALES

ombrellone a braccio laterale  
addossato in alluminio verniciato  
grigio antracite

lateral arm parasol attached to  
the wall in aluminium anthracite  
grey

- possibilità di  
posizionamento  
alla parete di  
aggancio
- predisposizione per  
aggancio tramite  
tirante
- placement attached  
to the wall
- prepared for  
docking by cable

scheda tecnica  
data sheet  
pag. 116









# ETERNITY

ombrellone a braccio  
laterale in alluminio

lateral arm parasol  
in aluminium

- gambone, tubo girevole e angoli zincati a caldo
- stecche intercambiabili, sezione 2,0x3,5
- hot galvanized leg, rotation tube and angle
- interchangeable ribs, section 2,0x3,5

scheda tecnica  
data sheet  
pag. 117









## PITAGORA

ombrellone a braccio laterale  
retrattile in alluminio  
verniciato grigio antracite e bianco  
retractable aluminium lateral  
arm parasol anthracite and white  
varnished

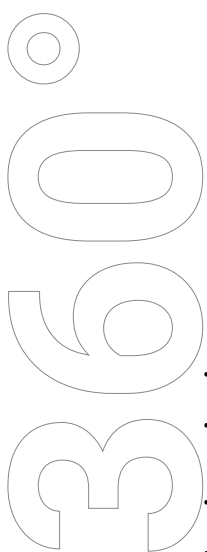

- sistema di chiusura retrattile
- versione standard con pendente
- retractable closing system
- standard version with flounce
- scheda tecnica data sheet
- pag. 118







## ECLISSE

ombrellone a braccio  
laterale in alluminio  
verniciato grigio antracite  
aluminium lateral arm  
parasol anthracite varnished



- dispositivo sollevamento  
telescopico brevettato per  
chiusura ombrellone (solo  
su 5x5)
- base optional
- patented telescopic lifting  
system for parasol closing  
(only on 5x5)
- optional base

scheda tecnica  
data sheet  
pag. 119







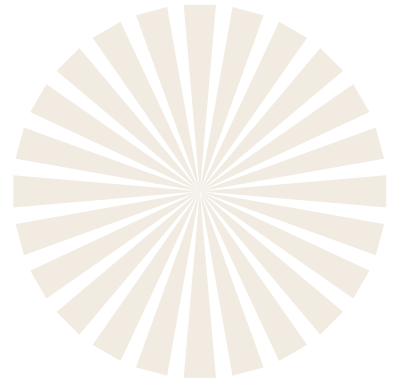

# OMBRELLONI A PALO CENTRALE

## CENTRAL POLE PARASOLS

DOLOMITI ALLUMINIO 72

DOLOMITI LEGNO 76

PETRARCA ALLUMINIO 80

PETRARCA LEGNO 84

OCEAN ALLUMINIO 88

OCEAN LEGNO 92

LAGUNA 94



# DOLOMITI ALLUMINIO

ombrellone a palo centrale  
in alluminio  
aluminium central  
pole parasol

- possibilità di fissaggio al suolo
- palo Ø 60
- possibility of fixing on the ground
- Ø 60 pole

scheda tecnica  
data sheet  
pag. 120













## DOLOMITI LEGNO

ombrellone  
a palo centrale  
in legno

wooden central  
pole parasol

- possibilità di fissaggio al suolo
- anche tinta Iroko
- possibility of fixing on the ground
- also iroko colour

scheda tecnica  
data sheet  
pag. 121





# PETRARCA ALLUMINIO

ombrellone a palo centrale  
telescopico in alluminio  
telescopic aluminium  
central pole parasol



- chiusura telescopica sopra i tavoli
- palo Ø 60
- telescopic system for closing over the tables below
- Ø 60 pole

scheda tecnica  
data sheet  
pag. 122

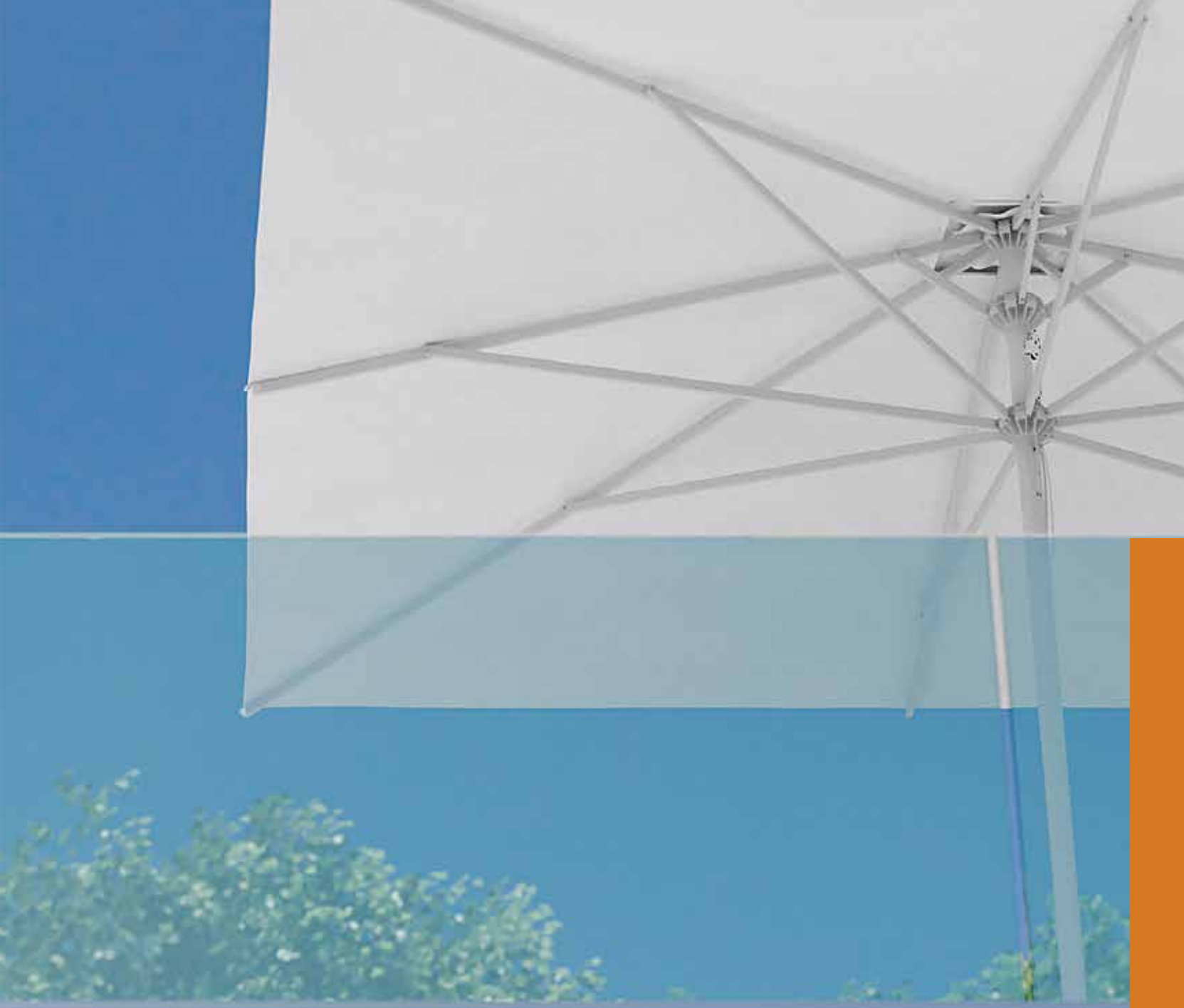





# PETRARCA LEGNO

ombrellone a palo centrale  
telescopico in legno  
telescopic wooden central  
pole parasol



- chiusura  
telescopica sui  
tavoli
- possibilità di  
fissaggio al suolo
- telescopic system  
for closing over the  
tables below
- possibility of fixing  
on the ground

scheda tecnica  
data sheet  
pag. 123







# OCEAN ALLUMINIO

ombrellone a palo centrale  
in alluminio  
aluminium central  
pole parasol

- apertura a sollevamento, senza carrucole
- opening system by lifting, without pulleys

scheda tecnica  
data sheet  
pag. 124







# OCEAN LEGNO

ombrellone a palo centrale  
in legno  
wooden central pole parasol





## LAGUNA

ombrellone a palo centrale  
in legno

wooden central pole parasol

- possibilità di  
fissaggio al suolo
- possibility of fixing  
on the ground

scheda tecnica  
data sheet  
pag. 125











# MEZZI OMBRELLONI

## HALF PARASOLS

CITY

100



## CITY

mezzo ombrellone  
in alluminio verniciato  
grigio antracite  
aluminium anthracite grey  
varnished half-parasol

- versione standard  
con pendente
- possibilità di  
fissaggio al suolo e  
a muro
- standard version  
with flounce
- possibility of fixing  
on the ground/to  
the wall

scheda tecnica  
data sheet  
pag. 126







# **SCHEDE TECNICHE**

# **TECHNICAL SHEET**

leonardo	104
galileo	106
fellini	107
saturno	108
vespucci	109
venere	110
afrodite	111
marte	112
riviera	113
horizon	114
flat	115
murales	116
eternity	117
pitagora	118
eclisse	119
dolomiti alluminio	120
dolomiti legno	121
petrarca alluminio	122
petrarca legno	123
ocean	124
laguna	125
city	126

## **ACCESSORI OPTIONALS** 128

## **TESSUTI FABRICS** 129





**OPTIONALS**

base: 106,5x106,5 cm

base: 106,5x106,5 cm

carter copribase

coverbase carter

finitura pendente:

flounce finishing:



merletti  
crenelation



onde  
wave

Impianto luci

a led bianche naturali

con telecomando (a luce

calda su richiesta)

natural white led lighting

system with remote control

(on demand 3000 K°)

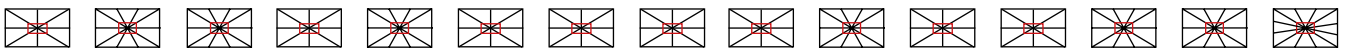
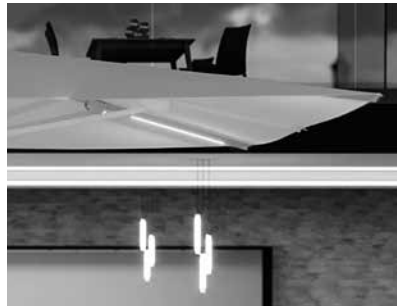
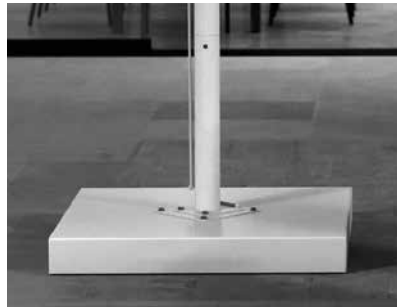

3x5	3x6	3x7	3,5x5	3,5x7	4x4,5	4x5	4,5x5,5	4x6	4x7	5x6	5x7	5x7	6x7	6x7
433	448	448	433	495		430	473	480	507	505	513	531	566	
328	326	338	328	351		320	340	340	371	352	369	381	392	
	201	220	213	215		210	225	230	234	227	233	247	268	
			0,46			0,46	0,39	0,49	0,52	0,52	0,53	0,53	0,56	
10	10	10	10	10	10	10	10	10	10	10	10	10	10	10
8	10	10	8	10	8	8	8	8	10	8	8	10	10	12
20x35	20x35 20x40	20x35 20x40	20x35	20x35 20x40	20x35	20x35	20x35	20x35	20x35 20x40	20x35	20x35 20x40	20x35 20x40	20x35 20x40	20x35 20x40
.	.	.	.	.	.	.	.	.	.	.	.	.	.	.
.	.	.	.	.	.	.	.	.	.	.	.	.	.	.

# galileo

ombrellone multiplo  
telescopico in alluminio  
multiple telescopic  
parasol in aluminium



## CARATTERISTICHE TECNICHE TECHNICAL DATA

possibilità di fissaggio al suolo  
possibility of fixing on the ground

ombrellone standard fornito  
con pendente  
standard version with flounce

stecche intercambiabili  
interchangeable ribs

con stecche antivento tra palo  
verticale e ragni  
anti-wind ribs between  
vertical pole and frames

stecche angolari 8x8 rinforzate  
reinforced angular ribs for 8x8

base maggiorata per  
le misure 7x7 e 8x8  
big base for size 7x7 e 8x8

di serie completo di 4 canaline  
standard with 4 gutters

parti metalliche prima zincate,  
poi verniciate  
metal parts galvanized and  
varnished

dispositivo sollevamento  
telescopico  
brevettato (escluso 6x6)  
patented telescopic lifting  
system (not 6x6)

## COLORI STRUTTURA FRAME COLOURS

 grigio antracite  
anthracite grey

 bianco  
white

## OPTIONALS

*carter copribase*  
*coverbase carter*

*finitura pendente:*  
*flounce finishing:*

 merletti  
crenelation

 onde  
wave

*impianto luci*  
*a led bianche naturali*  
*(a luce calda su richiesta)*  
*natural white led lighting*  
*system (on demand 3000 K°)*

DIMENSIONE / SIZE		6x6	7x7	8x8
A	ALTEZZA - TELESCOPIO SU HEIGHT - TELESCOPE UP	h. max (cm) 240	h. max (cm) 304	h. max (cm) 321
	ALTEZZA - TELESCOPIO GIÙ HEIGHT - TELESCOPE DOWN	h. min (cm) 240	h. min (cm) 254	h. min (cm) 271
DIMENSIONE EFFETTIVA REAL SIZE		605x605	715x715	815x815
VOLUME IMBALLO m <sup>3</sup> PACKED VOLUME m <sup>3</sup>		0,86	1,08	1,17
COLONNA VERTICALE VERTICAL COLUMN		11,2x11,2	11,2x11,2	11,2x11,2
PALI SUPERIORI (cm) UPPER POLES		9,2x9,2	9,2x9,2	9,2x9,2
STECHE (NR.) / RIBS		8x4	8x4	8x4
PENDENTE / FLOUNCE		•	•	•
TESSUTO / FABRIC Acrilico - Tempotest® Parà Ombrelloni - PVC Acrylic - Tempotest® Parà Parasols - PVC		•	•	•

# fellini

ombrellone multiplo  
in alluminio

multiple parasol  
in aluminium



## CARATTERISTICHE TECNICHE TECHNICAL DATA

possibilità di fissaggio al suolo  
possibility of fixing on the ground

stecche intercambiabili  
interchangeable ribs

con stecche antivento tra palo  
verticale e ragni  
anti-wind ribs between vertical pole  
and frames

stecche angolari 4x8 rinforzate  
reinforced angular  
ribs for 4x8

di serie completo di canalina  
standard with gutter

parti metalliche prima zincate,  
poi verniciate  
metal parts galvanized and  
varnished

base maggiorata per le misure  
3,5x7 a "V" e 4x8 a "V"  
big base for sizes 3,5x7 "V"  
and 4x8 "V"



## COLORI STRUTTURA FRAME COLOURS

 grigio antracite  
anthracite grey

 bianco  
white

## OPTIONALS









*carter copribase*  
*coverbase carter*

*finitura pendente:*  
*frounce finishing:*

 merletti  
crenelation

 onde  
wave

*impianto luci a led*  
*bianche naturali*  
*(a luce calda su richiesta)*  
*natural white led lighting*  
*system (on demand 3000 K°)*

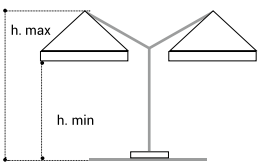
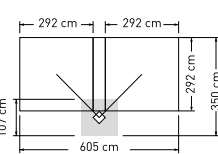
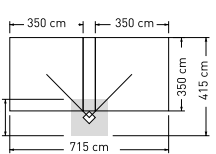
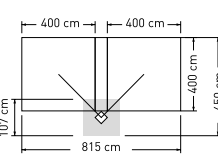
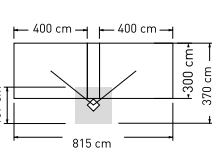
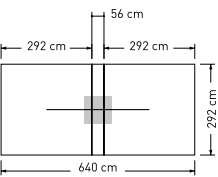
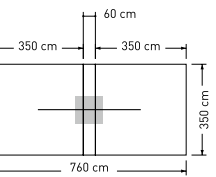
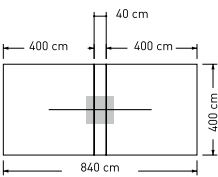
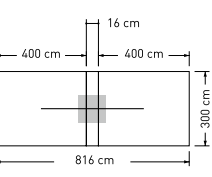
"V" VERSION					
"T" VERSION					
DIMENSIONE / SIZE	<b>3x6</b>	<b>3,5x7</b>	<b>4x8</b>	<b>3x8</b>	
	h. max (cm)	324	348"V"-336"T"	386"V"-374"T"	330
	h. min. (cm)	240	254"V"-242"T"	271"V"-259"T"	235
"V" VERSION					
"T" VERSION					
COLONNA VERTICALE VERTICAL COLUMN	11,2x11,2	11,2x11,2	11,2x11,2	11,2x11,2	
PALI SUPERIORI (cm) UPPER POLES	9,2x9,2	9,2x9,2	9,2x9,2	9,2x9,2	
STECHE (NR.) / RIBS	8x2	8x2	8x2	8x2	
PENDENTE / FLOUNCE	•	•	•	•	
TESSUTO / FABRIC	•	•	•	•	
Acrilico - Tempotest® Parà Ombrelloni - PVC Acrylic - Tempotest® Parà Parasols - PVC	•	•	•	•	

# saturno

ombrellone a braccio  
laterale in alluminio  
aluminium lateral  
arm parasol



## CARATTERISTICHE TECNICHE TECHNICAL DATA

possibilità di fissaggio al suolo  
possibility of fixing on the ground

parti metalliche prima zincate,  
poi verniciate  
metal parts galvanized and  
varnished

con stecca antivento tra palo  
verticale e ragno  
anti-wind rib between vertical  
pole and frame

stecche intercambiabili  
interchangeable ribs

stecche diagonali 4x4 rinforzate  
reinforced diagonal ribs for 4x4

girevole 360°  
360° rotating

ombrellone standard fornito  
con pendente  
standard version with flounce

## COLORI STRUTTURA FRAME COLOURS

 grigio antracite  
anthracite grey

 bianco  
white

## OPTIONALS

*carter copribase*

*coverbase carter*

*finitura pendente:*

*flounce finishing:*



merletti  
crenelation



onde  
wave

*impianto luci a led bianche  
(a luce calda su richiesta)  
natural white led lighting  
system (on demand 3000 K°)*

*fioriera in alluminio  
aluminium planter*

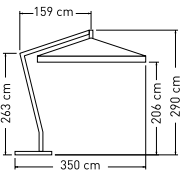
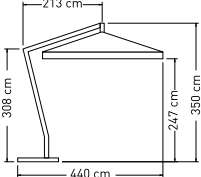
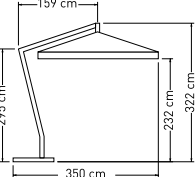

DIMENSIONE / SIZE	3x3	4x4	3x4
			
PALO (cm) / POLE	9,2x9,2	9,2x9,2	9,2x9,2
STECHE (NR.) / RIBS	8	8	8
PENDENTE / FLOUNCE	•	•	•
TESSUTO / FABRIC	•	•	•
Acrylic - Tempotest® Parà Ombrelloni - PVC Acrylic - Tempotest® Parà Parasols - PVC			

# vespucci

ombrellone a braccio  
laterale in legno  
wooden lateral  
arm parasol



## CARATTERISTICHE TECNICHE TECHNICAL DATA

possibilità di fissaggio al suolo  
possibility of fixing on the ground

parti metalliche prima zincate,  
poi verniciate  
metal parts galvanized  
and varnished

con stecca antivento tra palo  
verticale e ragno  
anti-wind rib between vertical pole  
and frame

girevole 360°  
360° rotating

## OPTIONALS

*carter copribase*  
*coverbase carter*

*finitura pendente:*  
*flounce finishing:*

 merletti  
crenelation

 onde  
wave

*impianto luci a led bianche*  
*(a luce calda su richiesta)*  
*natural white led lighting system*  
*(on demand 3000 K°)*

*fioriera in legno*  
*wooden planter*

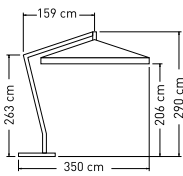
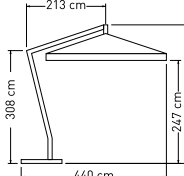
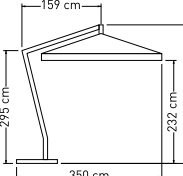

DIMENSIONE / SIZE	3x3	4x4	3x4
			
PALO (cm) / POLE	9,2x9,2	9,2x9,2	9,2x9,2
STECHE (NR.) / RIBS	8	8	8
PENDENTE / FLOUNCE	•	•	•
TESSUTO / FABRIC Acrilico - Tempotest® Parà Ombrelloni - PVC Acrylic - Tempotest® Parà Parasols - PVC	•	•	•

# venere

ombrellone a braccio  
laterale in alluminio  
verniciato grigio antracite  
aluminium lateral  
arm parasol anthracite  
varnished



## CARATTERISTICHE TECNICHE TECHNICAL DATA

possibilità di fissaggio al suolo  
possibility of fixing on the ground  
parti metalliche prima zincate,  
poi verniciate  
metal parts galvanized and varnished  
con stecca antivento tra palo  
verticale e ragno  
anti-wind rib between vertical  
pole and frame  
stecche intercambiabili  
interchangeable ribs  
girevole 360°  
360° rotating

## OPTIONALS

*carter copribase*  
*coverbase carter*

*finitura pendente:*  
*flounce finishing:*



merletti  
crenelation



onde  
wave

*impianto luci a led bianche*  
*(a luce calda su richiesta)*  
*natural white led lighting*  
*system (on demand 3000 K°)*

*fioriera in alluminio*  
*aluminium planter*



DIMENSIONE / SIZE	2x2	2,5x2,5	3x3	2x3	3x4
PALO (cm) / POLE	7,2x7,2	7,2x7,2	7,2x7,2	7,2x7,2	7,2x7,2
STECHE (NR.) / RIBS	5	5	8	6	8
PENDENTE / FLOUNCE	•	•	•	•	•
TESSUTO / FABRIC Acrilico - Tempotest® Parà Ombrelloni - PVC Acrylic - Tempotest® Parà Parasols - PVC	•	•	•	•	•

# afrodite

ombrellone a braccio  
laterale in alluminio  
verniciato bianco  
aluminium lateral arm  
parasol white varnished



## CARATTERISTICHE TECNICHE TECHNICAL DATA

possibilità di fissaggio al suolo  
possibility of fixing on the ground  
parti metalliche prima zincate,  
poi verniciate  
metal parts galvanized  
and varnished  
con stecca antivento tra palo  
verticale e ragno  
anti-wind rib between vertical  
pole and frame  
stecche intercambiabili  
interchangeable ribs  
girevole 360°  
360° rotating  
ombrellone standard  
fornito con pendente  
standard version  
with founce

## OPTIONALS

*carter copribase*

*coverbase carter*

*finitura pendente:*

*founce finishing:*



merletti  
crenelation



onde  
wave

*impianto luci a led bianche  
(a luce calda su richiesta)  
natural white led lighting  
system (on demand 3000 K°)*

*fioriera in alluminio  
aluminium planter*



DIMENSIONE / SIZE	3x3	2x3	3x4
PALO (cm) / POLE	7,2x7,2	7,2x7,2	7,2x7,2
STECHE (NR.) / RIBS	8	6	8
PENDENTE / FLOUNCE	•	•	•
TESSUTO / FABRIC Acrilico - Tempotest® Parà Ombrelloni - PVC Acrylic - Tempotest® Parà Parasols - PVC	•	•	•

# marTE

ombrellone a braccio  
laterale in alluminio  
verniciato tortora  
aluminium lateral arm  
parasol dove grey  
varnished



## CARATTERISTICHE TECNICHE TECHNICAL DATA

possibilità di fissaggio al suolo  
possibility of fixing on the ground  
parti metalliche prima zincate,  
poi verniciate  
metal parts galvanized and varnished  
con stecca antivento tra palo  
verticale e ragno  
anti-wind rib between vertical  
pole and frame  
stecche intercambiabili  
interchangeable ribs  
ombrellone standard fornito  
senza pendente  
standard version without flounce  
girevole 360°  
360° rotating

## OPTIONALS

*carter copribase*

*coverbase carter*

*finitura pendente:*

*flounce finishing:*



merletti  
crenelation



onde  
wave

*impianto luci a led bianche*

*(a luce calda su richiesta)*

*natural white led lighting  
system (on demand 3000 K°)*

*fioriera in alluminio*

*aluminium planter*



DIMENSIONE / SIZE

**3x3**

**2x3**

**3x4**

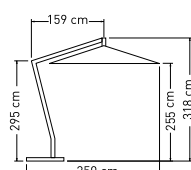
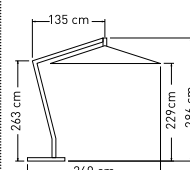
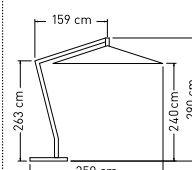

PALO (cm) / POLE

7,2x7,2

7,2x7,2

7,2x7,2

STECHE (NR.) / RIBS

8

6

8

TESSUTO / FABRIC

Acrilico - Tempotest® Parà Ombrelloni - PVC  
Acrylic - Tempotest® Parà Parasols - PVC

•

•

•

# riviera

ombrellone a braccio  
laterale in legno  
wooden lateral  
arm parasol



## CARATTERISTICHE TECNICHE TECHNICAL DATA

possibilità di fissaggio al suolo  
possibility of fixing on the ground

parti metalliche prima zincate,  
poi verniciate  
metal parts galvanized and  
varnished

con stecca antivento tra palo  
verticale e ragno  
anti-wind rib between vertical pole  
and frame

girevole 360°  
360° rotating

## OPTIONALS

*carter copribase*

*coverbase carter*

*finitura pendente:*

*flounce finishing:*



merletti  
crenelation



onde  
wave

*impianto luci a led bianche*  
*(a luce calda su richiesta)*  
*natural white led lighting*  
*system (on demand 3000 K°)*

*fioriera in legno*  
*wooden planter*



## DIMENSIONE / SIZE

	3x3	2x3	3x4
PALO (cm) / POLE	7,2x7,2	7,2x7,2	7,2x7,2
STECHE (NR.) / RIBS	8	6	8
PENDENTE / FLOUNCE	•	•	•
TESSUTO / FABRIC	•	•	•
Acrylic - Tempotest® Parà Ombrelloni - PVC Acrylic - Tempotest® Parà Parasols - PVC			

# horizon

ombrellone a braccio  
laterale orientabile  
in alluminio verniciato  
grigio antracite  
aluminium lateral  
orientable arm parasol  
anthracite varnished



## CARATTERISTICHE TECNICHE TECHNICAL DATA

possibilità di fissaggio al suolo  
possibility of fixing on the ground  
parti metalliche prima zincate,  
poi verniciate  
metal parts galvanized and varnished  
con stecca antivento tra palo  
verticale e ragno  
anti-wind rib between vertical  
pole and frame  
stecche intercambiabili  
interchangeable ribs  
ombrellone standard fornito  
senza pendente  
standard version without flounce  
girevole 360°  
360° rotating

## OPTIONALS

*carter copribase*  
*coverbase carter*  
*finitura pendente:*  
*flounce finishing:*

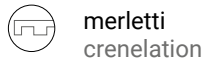

merletti  
crenelation



onde  
wave

*impianto luci a led bianche*  
*(a luce calda su richiesta)*  
*natural white led lighting*  
*system (on demand 3000 K°)*  
*fioriera in alluminio*  
*aluminium planter*

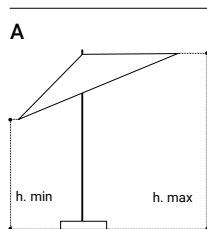

## DIMENSIONE / SIZE

DIMENSIONE / SIZE		3x3	2x3	3x4
A	h. max (cm)	290	286	320
	h. min. (cm)	180	190	155
PALO (cm) / POLE		7,2x7,2	7,2x7,2	7,2x7,2
STECHE (NR.) / RIBS		8	6	8
TESSUTO / FABRIC Acrylic - Tempotest® Parà Ombrelloni - PVC Acrylic - Tempotest® Parà Parasols - PVC		•	•	•

# flat

ombrellone a braccio  
laterale a ventaglio  
in alluminio  
fan shaped aluminium  
lateral arm parasol



## CARATTERISTICHE TECNICHE TECHNICAL DATA

apertura e chiusura a ventaglio  
con calamite e velcro  
fan shaped opening and closing  
with magnets and velcro  
possibilità di fissaggio al suolo  
possibility of fixing on the ground  
parti metalliche prima zincate,  
poi verniciate  
metal parts galvanized and varnished

stecche intercambiabili  
interchangeable ribs

ombrellone standard fornito  
senza pendente  
standard version  
without flounce  
girevole 360°  
360° rotating



orientabile a dx e a sx  
orientable right and left

## COLORI STRUTTURA FRAME COLOURS

● grigio antracite  
anthracite grey  
○ bianco  
white

## OPTIONALS

*carter copribase*  
*coverbase carter*  
*fioriera in alluminio*  
*aluminium planter*

1



2



3



4



DIMENSIONE / SIZE	2,5x2,5	2,8x2,8
PALO (cm) / POLE	7,2x7,2	7,2x7,2
STECHE (NR.) / RIBS	8	8
TESSUTO / FABRIC Acrilico - Tempotest® Parà Ombrelloni Acrylic - Tempotest® Parà Parasols	•	•

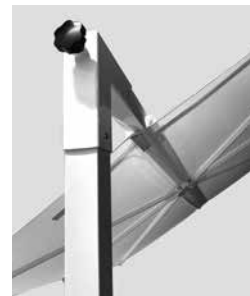

# murales

ombrellone a braccio laterale addossato  
in alluminio verniciato grigio antracite  
lateral arm parasol attached to the wall  
in aluminium anthracite grey



## CARATTERISTICHE TECNICHE TECHNICAL DATA

parti metalliche prima zincate,  
poi verniciate  
metal parts galvanized and  
varnished

stecche intercambiabili  
interchangeable ribs

possibilità di posizionamento  
aderente alla parete di aggancio  
placement attached to the wall

predisposizione per aggancio  
tramite tirante (operazione  
consigliata)

prepared for docking by cable  
(recommended)

## OPTIONALS

finitura pendente:  
frounce finishing:

 merletti  
crenelation

 onde  
wave



### Fissaggio consigliato

In presenza di cemento armato:  
Fischer  $\varnothing$  10  
If wall is in reinforced concrete:  
Fischer  $\varnothing$  10

In presenza di bimattone:  
Fischer con gabbia + chimico  
If wall is in perforated brick:  
Fischer with cage + chemical fixing

In presenza di cappotto:  
barre filettate  $\varnothing$  10  
If wall is with coat:  
Threaded bars  $\varnothing$  10



DIMENSIONE / SIZE

**2x2**

**2,5x2,5**

**3x3**

**2x3**

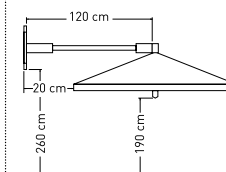
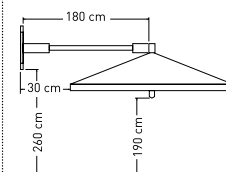
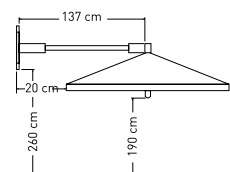
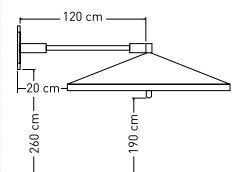

PALO (cm) / POLE

7,2x7,2

7,2x7,2

7,2x7,2

7,2x7,2

STECCHIE (NR.) / RIBS

4

4

8

6

PENDENTE / FLOUCE

•

•

•

•

TESSUTO / FABRIC

Acrilico - Tempotest® Parà Ombrelloni  
Acrylic - Tempotest® Parà Parasols

•

•

•

•

# eternity

ombrellone a braccio  
laterale in alluminio  
lateral arm parasol  
in aluminium





## CARATTERISTICHE TECNICHE TECHNICAL DATA

stecche intercambiabili,  
sezione 2,0x3,5  
interchangeable ribs,  
section 2,0x3,5  
parti metalliche prima zincate,  
poi verniciate  
metal parts galvanized  
and varnished  
gambone, tubo girevole e angolo  
zincati a caldo  
hot-galvanized leg, rotation  
tube and angle

possibilità di fissaggio  
al suolo  
possibility of fixing  
on the ground  
con stecca antivento tra palo  
verticale e ragno  
anti-wind rib between vertical  
pole and frame  
360° girevole  
360° rotating  
ombrellone standard  
fornito con pendente  
standard version  
with flounce

## COLORI STRUTTURA FRAME COLOURS

-  grigio antracite  
anthracite grey
-  bianco  
white

## OPTIONALS

*carter copribase*  
*coverbase carter*  
*finitura pendente:*  
*flounce finishing:*

 merletti  
crenelation

 onde  
wave

*impianto luci a led*  
*bianche (a luce calda*  
*su richiesta)*  
*natural white led lighting*  
*system (on demand 3000 K°)*  
*fioriera in alluminio*  
*aluminium planter*

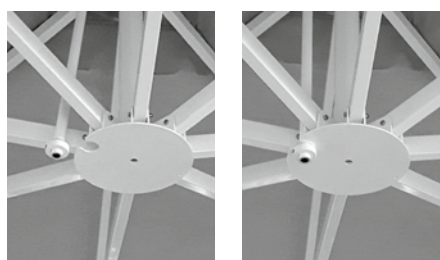

asta di sicurezza  
da inserire  
security bar  
to be inserted

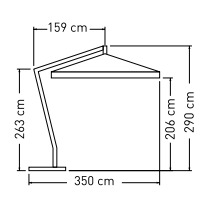
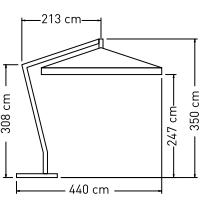
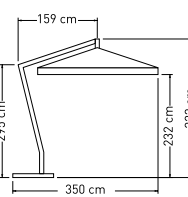

DIMENSIONE / SIZE	3x3	4x4	3x4
			
PALO (cm) / POLE	9,2x9,2	9,2x9,2	9,2x9,2
STECHE (NR.) / RIBS	8	8	8
PENDENTE / FLOUNCE	•	•	•
TESSUTO / FABRIC	•	•	•
Acrylic - Tempotest® Parà Ombrelloni - PVC Acrylic - Tempotest® Parà Parasols - PVC			

# pitagora

ombrellone a braccio  
laterale retrattile in alluminio  
verniciato grigio antracite  
e bianco

retractable aluminium  
lateral arm parasol  
anthracite and white  
varnished



## CARATTERISTICHE TECNICHE TECHNICAL DATA

sistema di chiusura retrattile  
retractable closing system  
possibilità di fissaggio al suolo  
possibility of fixing on the ground  
parti metalliche prima zincate,  
poi verniciate  
metal parts galvanized and  
varnished

con stecca antivento tra palo  
verticale e ragno  
anti-wind rib between vertical  
pole and frame  
stecche intercambiabili  
interchangeable ribs  
stecche diagonali 4x4 rinforzate  
reinforced diagonal  
ribs for 4x4

ombrellone standard fornito  
con pendente  
standard version with flounce

360° girevole  
360° rotating

## COLORI STRUTTURA FRAME COLOURS

● grigio antracite  
anthracite grey

○ bianco  
white

## OPTIONALS

*carter copribase*

*coverbase carter*

*finitura pendente:*

*flounce finishing:*



merletti  
crenelation



onde  
wave

*fioriera in alluminio*  
*aluminium planter*



## DIMENSIONE / SIZE

	3x3	4x4	3x4
PALO (cm) / POLE	9,2x9,2	9,2x9,2	9,2x9,2
STECHE (NR.) / RIBS	8	8	8
PENDENTE - FLOUNCE	•	•	•
TESSUTO / FABRIC Acrilico - Tempotest® Parà Ombrelloni - PVC Acrylic - Tempotest® Parà Parasols - PVC	•	•	•

# eclisse

ombrellone a braccio  
laterale in alluminio  
verniciato grigio antracite  
aluminium lateral arm  
parasol anthracite varnished



dispositivo  
sollevamento  
(solo su 5x5)  
lifting telescopic  
system  
(only for 5x5)

## CARATTERISTICHE TECNICHE TECHNICAL DATA

possibilità di fissaggio al suolo  
possibility of fixing on the ground  
stecche intercambiabili e rinforzate  
interchangeable and reinforced ribs  
parti metalliche prima zincate,  
poi verniciate  
metal parts galvanized and varnished  
dispositivo sollevamento telescopico  
brevettato che consente la chiusura  
dell'ombrellone (solo su 5x5)  
patented telescopic lifting system to  
close 5x5

con stecca antivento tra palo  
verticale e ragno  
anti-wind rib between vertical  
pole and frame  
ombrellone standard fornito  
con pendente  
standard version with flounce

## OPTIONALS

base 106,5x106,5  
base 106,5x106,5  
carter copribase  
coverbase carter  
finitura pendente:  
flounce finishing:



merletti  
crenelation



onde  
wave

impianto luci a led bianche  
(a luce calda su richiesta)  
natural white led lighting  
system (on demand 3000 K°)

asta di sicurezza  
da inserire  
security bar  
to be inserted

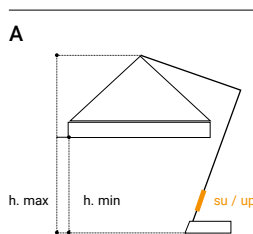

DIMENSIONE / SIZE		4,5x4,5	5x5	4x5
A	ALTEZZA - TELESCOPIO SU HEIGHT - TELESCOPE UP		440	
	h. max (cm) h. min. (cm)		304	
PALO (cm) / POLE		11,2x11,2	11,2x11,2	11,2x11,2
STECHE (NR.) / DIMENSIONI RIBS / DIMENSIONS		8 20x35	8 20x35	8 20x35
PENDENTE / FLOUNCE		.	.	.
TESSUTO / FABRIC Acrilico - Tempotest® Parà Ombrelloni - Tempotest® Parà Starlight Blue - PVC Acrylic - Tempotest® Parà Ombrelloni - Tempotest® Parà Starlight Blue - PVC		.	.	.

# dolomiti alluminio

ombrellone a palo centrale  
in alluminio  
aluminium central  
pole parasol



## CARATTERISTICHE TECNICHE TECHNICAL DATA

possibilità di fissaggio al suolo  
possibility of fixing on the ground

stecche intercambiabili  
interchangeable ribs

stecche diagonali 4x4 rinforzate  
reinforced diagonal ribs for 4x4

ombrellone standard fornito  
con pendente (no ø 3)  
standard version with  
flounce (no ø 3)

## COLORI STRUTTURA FRAME COLOURS

 grigio antracite  
anthracite grey

 bianco  
white

## OPTIONALS

finitura pendente:  
flounce finishing:

 merletti  
crenelation

 onde  
wave

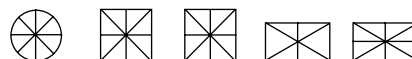
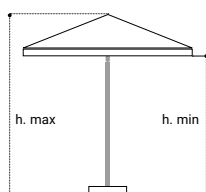

DIMENSIONE / SIZE		ø3	3x3	4x4	2x3	3x4
ALTEZZA CON BASE HEIGHT WITH BASE	h. max (cm)	263	263	328	263	294
	h. min (cm)	214	200	230	200	218
VOLUME IMBALLO m <sup>3</sup> PACKED VOLUME		0,08	0,10	0,14	0,09	0,12
PESO (Kg) / WEIGH		10,5	14,0	23,5	12	18,5
PALO (cm) / POLE		6,0	6,0	6,0	6,0	6,0
STECHE (NR.) / RIBS		8	8	8	6	8
PENDENTE / FLOUNCE		-	•	•	•	•
TESSUTO / FABRIC		•	•	•	•	•
Acrilico - Tempotest® Parà Ombrelloni - PVC Acrylic - Tempotest® Parà Parasols - PVC		•	•	•	•	•

# dolomiti legno

ombrellone a palo centrale  
in legno

wooden central  
pole parasol



## CARATTERISTICHE TECNICHE TECHNICAL DATA

possibilità di fissaggio al suolo  
possibility of fixing on the ground

## OPTIONALS

struttura tinta iroko (no  $\emptyset$  3 -  $\emptyset$  3,5)  
iroko colour structure (no  $\emptyset$  3 -  $\emptyset$  3,5)

finitura pendente:  
founce finishing:

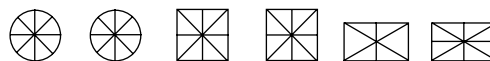
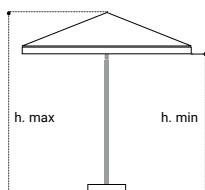
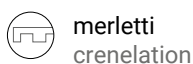

DIMENSIONE / SIZE		$\emptyset$ 3	$\emptyset$ 3,5	3x3	4x4	2x3	3x4
ALTEZZA CON BASE HEIGHT WITH BASE	h. max (cm)	276	276	276	336	276	308
	h. min (cm)	217	210	203	235	203	224
VOLUME IMBALLO m <sup>3</sup> / PACKED VOLUME		0,085	0,085	0,10	0,12	0,085	0,12
PESO (Kg) / WEIGH		13,0	13,0	17,0	29,0	13,0	23,0
PALO (cm) / POLE		4,8	4,8	4,8	5,8	4,8	4,8
STECHE (nr.) / RIBS		8	8	8	8	6	8
PENDENTE / FLOUNCE		-	-	•	•	•	•
TESSUTO / FABRIC		•	•	•	•	•	•
Acrilico - Tempotest® Parà Ombrelloni - PVC Acrylic - Tempotest® Parà Parasols - PVC							

# petrarca alluminio

ombrellone a palo  
centrale telescopico  
in alluminio  
telescopic aluminium  
central pole parasol



## CARATTERISTICHE TECNICHE TECHNICAL DATA

possibilità di fissaggio al suolo  
possibility of fixing on the ground

stecche intercambiabili  
interchangeable ribs

stecche diagonali 4x4 rinforzate  
reinforced diagonal ribs for 4x4

sistema a doppio ragno che consente  
la chiusura sopra i tavoli sottostanti

telescopic system for closing  
over the tables below

ombrellone standard  
fornito con pendente  
standard version with flounce

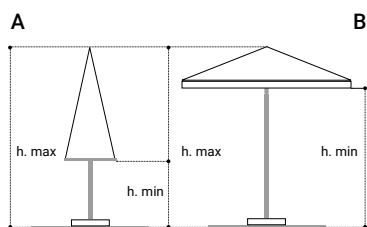

## COLORI STRUTTURA FRAME COLOURS

 grigio antracite  
anthracite grey

 bianco  
white

## OPTIONALS

finitura pendente:  
flounce finishing:

 merletti  
crenelation

 onde  
wave



DIMENSIONE / SIZE			3x3	4x4	3x4
A	ALTEZZA CHIUSO CON BASE HEIGHT CLOSED WITH BASE	h. max (cm)	300	363	328
		h. min. (cm)	89	80	77
B	ALTEZZA APERTO CON BASE HEIGHT OPENED WITH BASE	h. max (cm)	270	320	300
		h. min. (cm)	205	228	212
VOLUME IMBALLO (SENZA BASE) m <sup>3</sup> PACKED VOLUME (WITHOUT BASE)			0,13	0,15	0,14
PESO (Kg) / WEIGH			17,5	25	20
PALO (cm) / POLE			6,0	6,0	6,0
STECHE (NR.) / RIBS			8	8	8
PENDENTE / FLOUNCE			.	.	.
TESSUTO / FABRIC			.	.	.
Acrilico - Tempotest® Parà Ombrelloni - PVC Acrylic - Tempotest® Parà Parasols - PVC			.	.	.

# petrarca legno

ombrellone a palo  
centrale telescopico  
in legno  
telescopic wooden  
central pole parasol



## CARATTERISTICHE TECNICHE TECHNICAL DATA

possibilità di fissaggio al suolo  
possibility of fixing on the ground

ombrellone standard  
fornito con pendente  
standard version with flounce

sistema a doppio ragno  
che consente la chiusura sopra  
i tavoli sottostanti  
telescopic system for closing  
over the tables below



## OPTIONALS

finitura pendente:  
flounce finishing:

 merletti  
crenelation

 onde  
wave

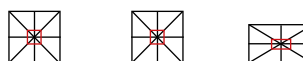
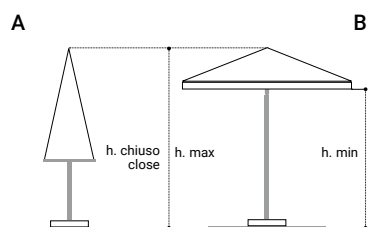
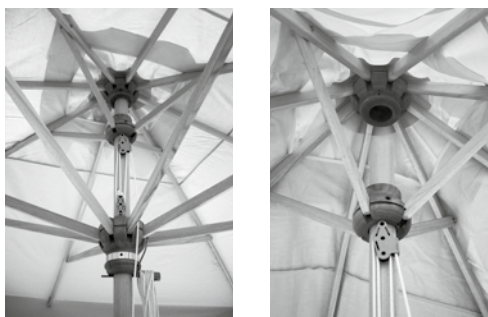

DIMENSIONE / SIZE		3x3	4x4	3x4	
A	ALTEZZA CHIUSO CON BASE HEIGHT CLOSED WITH BASE	300	383	347	
B	ALTEZZA APERTO CON BASE HEIGHT OPENED WITH BASE	h. max (cm)	274	334	308
		h. min. (cm)	205	240	224
VOLUME IMBALLO (SENZA BASE) m <sup>3</sup> PACKED VOLUME (WITHOUT BASE)		0,10	0,15	0,14	
PESO (Kg) / WEIGH		18	31	24	
PALO (cm) / POLE		4,8	5,8	4,8	
STECHE (NR.) / RIBS		8	8	8	
PENDENTE / FLOUNCE		•	•	•	
TESSUTO / FABRIC Acrylic - Tempotest® Parà Ombrelloni - PVC Acrylic - Tempotest® Parà Parasols - PVC		•	•	•	





## ocean alluminio

ombrellone a palo centrale  
in alluminio  
aluminium central  
pole parasol

### CARATTERISTICHE TECNICHE TECHNICAL DATA

possibilità di fissaggio al suolo  
possibility of fixing on the ground  
ombrellone standard  
fornito senza pendente  
standard version without flounce  
apertura a sollevamento,  
senza carrucole  
opening system by lifting,  
without pulleys

### COLORI STRUTTURA FRAME COLOURS

-  grigio antracite  
anthracite grey
-  bianco  
white

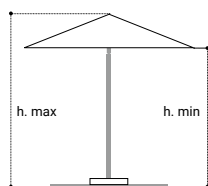

## ocean legno

ombrellone a palo centrale  
in legno  
wooden central  
pole parasol

### CARATTERISTICHE TECNICHE TECHNICAL DATA

possibilità di fissaggio al suolo  
possibility of fixing on the ground  
ombrellone standard  
fornito senza pendente  
standard version without flounce  
apertura a sollevamento,  
senza carrucole  
opening system by lifting,  
without pulleys



DIMENSIONE / SIZE		Ø2	Ø2,5	Ø3	2x2	2,5x2,5	2,8x2,8	2x3
ALTEZZA CON BASE HEIGHT WITH BASE	h. max (cm)	246	246	246	246	251	260	251
	h. min. (cm)	208	200	198	200	200	210	193
PALO (cm) / POLE		3,8	3,8	3,8	3,8	3,8	3,8	3,8
STECHE (NR.) / RIBS		6	6	6	4	4	4	4
TESSUTO / FABRIC		.	.	.	.	.	.	.
Olefin 190 g - tinto in massa Olefin 190 g - high color stability		.	.	.	.	.	.	.

# laguna

ombrellone a palo centrale  
in legno

wooden central  
pole parasol



## CARATTERISTICHE TECNICHE TECHNICAL DATA

possibilità di fissaggio al suolo  
possibility of fixing on the ground

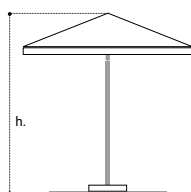

DIMENSIONE / SIZE	2x2	3x3	2x3
ALTEZZA HEIGHT	265	270	270
VOLUME IMBALLO (SENZA BASE) m <sup>3</sup> PACKED VOLUME (WITHOUT BASE)	0,05	0,10	0,085
PESO (Kg) / WEIGH	7,5	14	8
PALO (cm) / POLE	3,8	4,8	3,8
STECHE (NR.) / RIBS	4	8	6
PENDENTE / FLOUNCE	•	•	•
TESSUTO / FABRIC Olefin 190 g - tinto in massa Olefin 190 g - high color stability	•	•	•

# city

mezzo ombrellone in alluminio  
verniciato grigio antracite  
aluminium anthracite grey  
varnished half-parasol



## CARATTERISTICHE TECNICHE TECHNICAL DATA

possibilità di fissaggio  
al suolo e a muro  
possibility of fixing on the  
ground/to the wall

ombrellone standard fornito  
con pendente  
standard version with flounce

stecche intercambiabili  
interchangeable ribs for

## OPTIONALS

*finitura pendente:*  
*flounce finishing:*

 merletti  
crenelation

 onde  
wave

*staffa di fissaggio a muro*  
*plate for fixing to the wall*

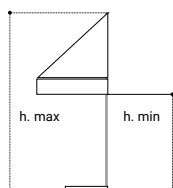

DIMENSIONE / SIZE		1,5x2	1,5x3	2x3	2x4
ALTEZZA CON PIASTRA ACCIAIO HEIGHT WITH STEEL PLATE	h. max (cm)	255	255	285	315
	h. min. (cm)	192	183	218	223
VOLUME IMBALLO m <sup>3</sup> PACKED VOLUME m <sup>3</sup>		0,09	0,10	0,12	0,14
PALO (cm) / POLE		6	6	6	6
STECHE (NR.) / RIBS		4	5	5	5
PENDENTE / FLOUNCE		•	•	•	•
TESSUTO / FABRIC Acrilico - Tempotest® Parà Ombrelloni - PVC Acrylic - Tempotest® Parà Parasols - PVC		•	•	•	•

## ZAVORRA MINIMA - MINIMUM WEIGHT

Il peso della zavorra sulla base deve essere proporzionato al peso e alle dimensioni dell'ombrellone. Se ne consiglia comunque l'uso in condizioni meteorologiche sostanzialmente normali.

It is recommended the weight of the base proportionate to the weight of the parasol and the use with normal meteorological conditions.

MODELLO / MODEL	PIASTRA LAVATO 40x40	PIASTRA LAVATO 50x50	PIASTRONE CEMENTO 40x40 con maniglie	PIASTRONE CEMENTO 50x50 con maniglie
	WASHED PLATE 40x40	WASHED PLATE 50x50	BIG WASHED PLATE 40x40 with handles	BIG WASHED PLATE 50x50 with handles
LEONARDO		x 12		x 4
LEONARDO 6x6 a 12 stecche LEONARDO 6x6 with 12 ribs LEONARDO 5x7 a 10 stecche LEONARDO 5x7 with 10 ribs LEONARDO 6,5x6,5 LEONARDO 6,5x6,5 LEONARDO 7x7 LEONARDO 7x7 LEONARDO 6x7 LEONARDO 6x7		x 24		x 8
GALILEO 6X6		x 12		x 4
GALILEO 7x7 - 8x8		x 24		x 8
FELLINI "T"		x 12		x 4
FELLINI "V" 3X6 - 3X8		x 12		x 4
FELLINI "V" 3,5x7 - 4x8		x 24		x 8
ECLISSE		x 24		x 8
ETERNITY 3x3		x 8		x 4
ETERNITY 3x4		x 10		x 4
ETERNITY 4x4		x12		x4
FLAT		x 6		x 2
2x2 TUTTI I MODELLI A BRACCIO LATERALE 2x2 ALL LATERAL ARM MODELS		x 6		x 2
2,5x2,5 TUTTI I MODELLI A BRACCIO LATERALE 2,5x2,5 ALL LATERAL ARM MODELS		x 6		x 2
2x3 TUTTI I MODELLI A BRACCIO LATERALE 2x3 ALL LATERAL ARM MODELS		x 6		x 2
3x3 TUTTI I MODELLI A BRACCIO LATERALE 3x3 ALL LATERAL ARM MODELS		x 8		x 4
3x4 TUTTI I MODELLI A BRACCIO LATERALE (NO Eternity) 3x4 ALL LATERAL ARM MODELS (NO ETERNITY)		x 8		x 4
4x4 TUTTI I MODELLI A BRACCIO LATERALE (NO Eternity) 4x4 ALL LATERAL ARM MODELS (NO ETERNITY)		x 10		x 4
CITY 1,5x2 - 1,5x3 - 2x3	PIASTRA ACCIAIO 70x70 - STEEL PLATE 70x70			x 1
CITY 2x4	PIASTRA ACCIAIO 100x100 - STEEL PLATE 100x100			x 1

MODELLO / MODEL	BASE ROTONDA GRANIGLIA 25 Kg.	BASE ROTONDA GRANIGLIA 35 Kg.	BASE ROTONDA GRANIGLIA 50 Kg.	BASE ROTONDA GRANIGLIA 70 Kg. con maniglie	PIASTRA ACCIAIO 70x70	PIASTRA ACCIAIO 100x100
	ROUND GRIT BASE 25 Kg.	ROUND GRIT BASE 35 Kg.	ROUND GRIT BASE 50 Kg.	ROUND GRIT BASE 70 Kg. with handles	STEEL PLATE 70x70	STEEL PLATE 100x100
DOLOMITI LEGNO / ALLUMINIO		2x3	ø3 - ø3,5 3x3 - 3x4 4x4		ø3 - ø3,5 2x3 - 3x3	3x4 4x4
PETRARCA LEGNO / ALLUMINIO			3x3	3x4 - 4x4		3x3 - 3x4 - 4x4
OCEAN	ø2 - ø2,5 2x2	ø3 2,5x2,5 2,8x2,8 2x3			ø2 - ø2,5 ø3 - 2x2 2,5x2,5 2,8x2,8 2x3	
LAGUNA		2x2 2x3	3x3		2x2 2x3 - 3x3	

# accessori optionals



## LAVORAZIONI PENDENTI FLOUNCE FINISHING



**merletti**  
crenelation

**onde**  
wave



## CANALINE GUTTERS

di serie in GALILEO  
e FELLINI.  
standard for GALILEO  
and FELLINI.

Con zip, velcro e Cristal  
all'interno, per LEONARDO  
in tessuto.

Lined with zip, velcro  
and Cristal inside, for  
LEONARDO in fabric.



## FODERI PROTECTION COVERS

In acrilico ecrù o PVC  
per tutti i modelli.  
In acrylic ecrù or PVC  
for all the models.



## IMPIANTO LED A LUCE BIANCA NATURALE 4000 K\* (SU RICHIESTA A 3000 K\* CALDA)

NATURAL WHITE LED LIGHTING  
SYSTEM 4000K\* (ON DEMAND 3000K\*)

Impianto integrato per LEONARDO  
ed ECLISSE, con telecomando.  
Integrated lighting system, remote  
control included, for LEONARDO  
and ECLISSE.

Impianto universale integrato  
(vedi modelli a braccio laterale  
su cui previsto).

Integrated universal lighting system  
(see the models on which it is intended).



## BASI IN GRANIGLIA GRIT BASES

Per ombrelloni con palo  
centrale:

For the parasols with  
central poles:  
Ø 38, Ø 48, Ø 58, Ø 60

Kg. 70

Con maniglie e tubo con piastra  
a doppio foro.

With handles and complete tube  
with double hole plate.

Kg. 50 - Kg. 35

Con tubo e piastra a doppio  
foro.

Complete tube with double hole  
plate.

Kg. 25

Con tubo e piastra a foro unico.  
Complete tube with single hole  
plate.



## CONTROPIASTRE COUNTERPLATES

Da cementare a scomparsa.  
To be cemented and flush  
fitted.

Per fissaggio a pavimento.  
For fixing into the floor.



## PIASTRE LAVATO WASHED PLATES

50x50  
Per ombrellone  
LEONARDO, per tutti i  
modelli multipli  
e a braccio laterale.

For LEONARDO, for all the  
multiple and lateral arm  
models.

40x40

Per PETRARCA  
For PETRARCA



## PIASTRONI CEMENTO BIG WASHED PLATES

50x50 - 40x40  
CON MANIGLIE  
Per ombrellone LEONARDO,  
CITY, per tutti i modelli  
multipli e a braccio laterale

WITH HANDLES  
For LEONARDO, CITY, for  
all the multiple and lateral  
arm models.



## PIASTRA ZINCATA E VERNICIATA GALVANIZED AND PAINTED STEEL PLATE

20x20

Solo per fissaggio a  
pavimento.

Just for fixing into the floor.

70x70 - kg. 21

Anche con tubo decentrato  
per CITY.

Also with decentralized tube  
for CITY.

100x100 - kg 40

Anche con tubo decentrato  
per CITY 2x4.

Also with decentralized tube  
for CITY 2x4.



## FIORIERA ALLUMINIO ALUMINIUM PLANTER

Antracite, bianca, tortora.  
Anthracite, white, dove colour.

Misure:  
Dimensions:  
104x50x34 cm.



## FIORIERA LEGNO WOODEN PLANTER

Misure:  
Dimensions:  
104x50x34 cm.



## CARTER COPRI BASE CARTER BASE COVER

Vedi modelli su cui  
previsto.  
see the models on which it  
is intended.

# tessuti fabrics

Le immagini stampate non riproducono perfettamente i colori e i toni dei nostri modelli. L'azienda si riserva di apportare tutte le modifiche ritenute necessarie al continuo miglioramento e rinnovamento dei modelli.

The printed images do not reproduce perfectly the colours and shades of our models. The company reserves the rights to make all modification necessary for the improvement and renewal of the model.

## ACRILICO / ACRYLIC

gr. 320 m/q.



ECRU

BIANCO

CORDA

## TEMPOTEST® PARÀ OMBRELLONI / PARASOLS

gr. 300 m/q. tinto in massa / dyed in bulk

TEMPOTEST®  
ITALIAN PERFORMANCE FABRICS

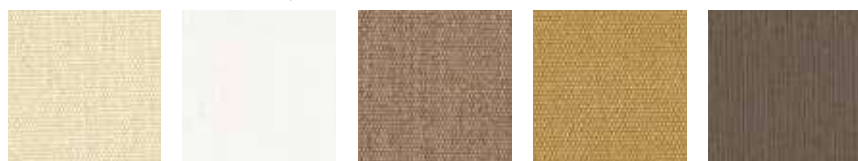

ECRU  
Cod. 151/15

BIANCO  
Cod. 15

NOCCIOLA  
MELANGIATO  
Cod. 106

CORDA  
Cod. 14

TORTORA  
Cod. 926



GRIGIO  
COD. 97/15

GRIGIO CHIARO  
COD. 79

GRIGIO CHIARO  
TRAMATO  
COD. 986/727

TESTA DI MORO  
COD. 81

NERO  
COD. 24



BORDEAUX  
COD. 73

VERDE BOSCO  
COD. 5

TERRACOTTA  
COD. 426

GIALLO  
COD. 12/15

## TEMPOTEST® PARÀ STARLIGHT BLUE

tinto in massa / dyed in bulk

TEMPOTEST®  
ITALIAN PERFORMANCE FABRICS



NOCCIOLA  
COD. 6236/590

ANTRACITE  
COD. 6253/597

GRIGIO CHIARO  
COD. 6231/597

ECRU  
COD. 6254/551

PVC  
gr. 500 m/q.



BIANCO  
COD. 867

ECRU  
COD. 7462

## OLEFIN

gr. 190 tinto in massa / dyed in bulk

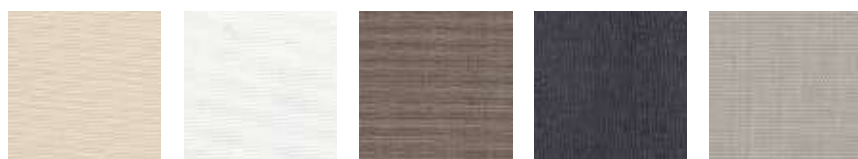

ECRU 2710

BIANCO 2602

TORTORA 2739

ANTRACITE 2657

GRIGIO CHIARO 2649





## AVVERTENZE WARNINGS

- Il peso della zavorra sulla base deve essere proporzionato al peso e alle dimensioni dell'ombrellone. Se ne consiglia comunque l'uso in condizioni metereologiche sostanzialmente normali.
  - A stagione conclusa, assicurarsi che il telo sia asciutto prima di riporre l'ombrellone, onde evitare eventuali formazioni di muffa.
  - Chiudere sempre l'ombrellone al termine dell'utilizzo.
  - Per facilitarne l'apertura, accompagnare le stecche corte verso l'esterno.
  - Nei modelli a braccio laterale, ad ombrellone chiuso, assicurarsi che il cavo per l'apertura sia sempre in tensione.
  - Non trascinare a terra gli ombrelloni ma sollevarli, onde evitare di rovinare la tela (effetto buco da sigaretta).
- It is recommended the weight of the base proportionate to the weight of the parasol and the use with normal meteorological conditions.
  - At concluded season, be sure that the fabric is dry before putting parasol back, to avoid possible mould formations.
  - To make the opening easier, take the short ribs towards the outside ones.
  - Close always parasols at the end of the use.
  - In lateral arm models, the cable have to be always in tension when parasol is closed.
  - Do not drag parasols but raise them (even if packaged). Ombrellificio Veneto® cannot be responsible for damages by dragging (holes like bore by cigarette at the corner of the flounces).

Photo and render:  
Grafiche Antiga spa  
Pellizzari - Rigo

Graphic design, layout and printing:  
Grafiche Antiga spa

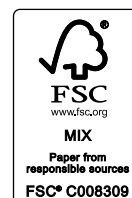





**Ombrellificio Veneto Srl**  
Via dell'Industria, 5  
35044 Montagnana (PD) - Italy

Tel. +39 0429 804098  
Fax +39 0429 804096

[www.ombrellificioveneto.it](http://www.ombrellificioveneto.it)  
[commerciale@ombrellificioveneto.it](mailto:commerciale@ombrellificioveneto.it)